

Duality and domains in supersymmetric gauge theories



Trinity College Dublin
Coláiste na Tríonóide, Baile Átha Cliath
The University of Dublin

Johannes Aspman

Supervisor: Prof. Jan Manschot

School of Mathematics
Trinity College Dublin

This dissertation is submitted for the degree of
Doctor of Philosophy

Declaration

I declare that this thesis has not been submitted as an exercise for a degree at this or any other university and it is entirely my own work. I agree to deposit this thesis in the University's open access institutional repository or allow the Library to do so on my behalf, subject to Irish Copyright Legislation and Trinity College Library conditions of use and acknowledgement. I consent to the examiner retaining a copy of the thesis beyond the examining period, should they wish so.

The main results of this thesis are based on the publications [1–3] together with Elias Furrer and Jan Manschot, the publication [4] together with Elias Furrer, Giorgios Korpas, Zhi-Cong Ong and Meng-Chwan Tan as well as the preprint [5] together with Elias Furrer and Jan Manschot. All of these references are collaborative work between me and the listed coauthors. The aim of the thesis is to review these results and add further explanations where needed, although the main results remain the same.

During the course of my PhD I have also contributed to the preprint [6], together with Christos Aravanis, Giorgios Korpas and Jakub Marecek. This is, however, not part of the thesis.

Johannes Aspman
2023

Summary

Dualities play an important role in our understanding of many areas of modern theoretical physics. Supersymmetric gauge theories provides a rich ground for the study of the dynamics of dualities, where typically this manifests itself by equating the dynamics of quantum field theories at distinct values of the coupling.

In this thesis, we investigate the manifestation of strong/weak duality in the low-energy effective description of four-dimensional $\mathcal{N} = 2$ supersymmetric Yang-Mills theory, or what is called Seiberg-Witten (SW) theory. In particular, we focus on the structure of the Coulomb branch – where the gauge group is broken to factors of $U(1)$ – of these theories and its connection to modularity. To study this branch we make use of the insight of Seiberg and Witten that many of its important structures are captured by the introduction of an auxiliary family of elliptic curves. The study of the Coulomb branch thus reduces to a study of these curves.

For the pure SW theory with gauge group $SU(2)$ it is known that the duality group is given by a congruence subgroup of $SL(2, \mathbb{Z})$, and this is further captured by the fact that the order parameter on the moduli space can be expressed as a modular function of the running coupling for this subgroup. Similar results have been known for the theories with massless fundamental hypermultiplets. In this thesis we show that this is not the general story. When, for example, including $N_f \leq 4$ massive fundamental hypermultiplets the modular properties become much more subtle. In general, the order parameter will have branch points as a function of the coupling. In light of these complications, we develop new techniques to study the Coulomb branch and in particular discuss how to construct fundamental domains for the order parameter incorporating the branch points. The branch points, and related cuts, provide further a natural mechanism for interpolating through phase transitions such as the superconformal fixed points of Argyres-Douglas type, where mutually non-local dyons become massless.

For the pure theory with gauge group $SU(3)$ we instead have a genus two SW curve, and the moduli space is now parameterised by two complex functions. On special slices of the moduli space, where one of the order parameters vanish, the genus two SW curve degenerates into two elliptic curves. We show that the non-zero order parameter on these slices can be expressed in terms of elliptic modular forms. Since these slices further capture all important points of the moduli space, these results can be used to interpolate between the various duality frames near these points. In particular, it

provides a way to straightforwardly interpolate between strong and weak coupling in order to analyse the spectrum of the theory.

The modular properties of the SW theories play an important role when calculating topological correlators. Topologically twisted versions of $\mathcal{N} = 2$ theories have been essential in the interplay between modern physics and mathematics. One of the most famous instances being that of Donaldson-Witten theory, where four-dimensional $\mathcal{N} = 2$ supersymmetric Yang-Mills theory is used to calculate Donaldson's famous four-manifold invariants. In the physical theory, this corresponds to calculating certain correlators in the topologically twisted theories. In particular, we can make use of the flow to the IR, or to the SW theory, after twisting to make the explicit evaluations. In recent years, these correlators have seen a revived interest due to the observation that they can be related to the theory of mock modular forms. The integrand can be written as a total derivative of a mock modular form, and through Stokes' theorem the integration then reduces to one over the boundaries of the fundamental domain. In light of this, we consider the theories with massive matter included and formally construct the Coulomb branch integral for these theories. To make the theories with fundamental matter well-defined on generic four-manifolds we need to introduce a coupling to extra background fluxes when performing the twist. These fluxes then give rise to new families of partition functions.

The recent results, as well as our discussion when including massive matter, on the relation between the Coulomb branch integral and mock modular forms have restricted the analysis to simply connected manifolds. In this thesis, we generalise these results to any four-manifold, and in particular to non-simply connected manifolds. We further check our results against known results on a specific class of non-simply connected manifolds, namely product ruled surfaces.

Acknowledgements

First of all, I would like to send my deepest thank you to my supervisor Jan Manschot for your excellent guidance throughout these last four years and for allowing me the opportunity to work with and learn from you. Your interest for, and expertise of, physics and mathematics has been very inspirational for me and I have enjoyed all of our discussions and collaborations immensely.

Secondly, a very big and heartfelt thank you goes also to my foremost collaborator and office mate, Elias Furrer. I have learnt so much from you throughout the years and have enjoyed every bit of our collaborations greatly. Our many discussions on everything between heaven and earth (physics, chess, climbing, music, food, chocolate, and so much more) have been a vital component of my PhD period. I truly could not have wished for a better colleague.

I would also like to thank all of my other collaborators. This thesis is based on work together with Elias Furrer, Georgios Korpas, Jan Manschot, Zhi-Cong Ong and Meng-Chwan Tan. Thank you all for allowing me to work with you. It has been very interesting, fruitful and enjoyable to work with you all. Furthermore, I would like to thank Cyril Closset, Horia Magureanu, Gregory Moore, Matthew Rochford and Antoine Vincenti for collaborating with me on various ongoing projects. Horia, I hope me, you and Elias will have many more pints in the future. Finally, I would also like to thank my collaborators Christos Aravanis, Georgios Korpas and Jakub Marecek for showing me a world of research outside of hep-th and including me in your various projects.

I am very thankful to everyone at the School of Mathematics for creating a wonderful environment for a young researcher to thrive in. Special thanks goes of course to all my fellow PhDs and post-docs, Ana, Andrea, Anne, Araditha, Chiara, Georgios, Gim Seng, Guy, Marianne, Martijn, the Nicos (1 and 2), Paul, Petar, Raul, Riccardo, Robin, Sam, Swapno and Zhi-Zhen for all the friday fikas, birthday bashes, mango Mondays and whisky Wednesdays. A very special thank you goes to my fellow Swede at Trinity, Robin, for the many stimulating discussions, coffee sessions, excursions, climbing sessions, chess games, puzzles and for everything else. It is gonna be very strange doing physics without having you in the same department.

Finally, I would like to thank my family and friends. First of all, Örjan, Kristofer, Maja, Ellen, Andreas, Julius, Esmeralda, Maria, Pontus and Ebbe, thank you for being the best family in the world and for always being there to support me (as well as allowing me to occupy our house for one and a half years of lockdowns). Secondly, my

many fantastic friends outside of research, both in Ireland and in Sweden. I will not even try to mention you all, but I hope you know how much I appreciate every last one of you. A special mention of course goes to the youngest generation Bo, Emil, Hannes, Maja, Stella and Vera for allowing me to goof around with you. And lastly, a huge special thanks to Kristin for (amongst many other things) proofreading parts of the thesis.

My PhD was funded both by the Laureate Award 15175 “Modularity in Quantum Field Theory and Gravity” of the Irish Research Council and the Government of Ireland Postgraduate Scholarship Programme GOIPG/2020/910 of the Irish Research Council.

Dedicated to my father, Örjan, and my nephew, Ebbe, for the many inspirational discussions in the past, present and future.

Table of contents

Preface	xiii
1 Duality, domains and Seiberg-Witten theory	1
1.1 Duality in Seiberg-Witten theory	1
1.2 Construction and application of fundamental domains	10
2 Cutting and gluing with running couplings	17
2.1 Massive fundamental hypers	17
2.2 The case of two hypermultiplets	34
2.3 The special case of four flavours	45
3 Elliptic loci of SU(3) vacua	59
3.1 Seiberg-Witten geometry of SU(3)	59
3.2 Non-perturbative analysis	62
3.3 Locus \mathcal{E}_u : $v = 0$	67
3.4 Locus \mathcal{E}_v : $u = 0$	75
3.5 Geometrical interpretation in terms of elliptic curves	80
3.6 Monodromies	83
4 Integrating over the u-plane	93
4.1 Special geometry and SW theories	93
4.2 The UV theory on a four-manifold	97
4.3 The effective theory on a four-manifold	104
4.4 The u -plane integral	109
4.5 Integration over fundamental domains	113
4.6 Non-simply connected manifolds	118
5 Conclusions and outlook	135
Appendix A Elliptic and modular curves	137
A.1 Elliptic curves and complex tori	137
A.2 Modular curves and subgroups	139
A.3 Kodaira classification of singular fibres	140

A.4	Atkin-Lehner involutions	141
Appendix B Automorphic forms		143
B.1	Elliptic modular forms	143
B.2	Siegel-Narain theta function	146
B.3	Indefinite theta functions	147
B.4	Bimodular forms	148
B.5	Siegel modular forms	149
Appendix C Picard-Fuchs solutions for SU(3) theory		151
C.1	Classical roots	151
C.2	Picard-Fuchs system for large u	153
C.3	Picard-Fuchs system for large v	153
C.4	The \mathbb{Z}_2 vacua and massless states	154
References		159

Preface

Our fundamental understanding of modern particle physics, and thus of the microscopic behaviour of Nature, is to a large extent based on a set of theories called *gauge theories*. This thesis will discuss the important concept of *dualities* in quantum gauge theories as well as that of *fundamental domains* for an important parameter of the gauge theories called the coupling constant. In these first few pages we will give a brief overview of these topics aimed at the non-technical reader.

Duality in modern gauge theory

Dualities are ubiquitous in modern physics and have provided us with many new deep insights in both physics and pure mathematics on a fundamental level.

To better understand dualities we first need to say a few words about what we mean when we talk about a physical theory as well as different regimes of a theory. In this thesis we will be concerned with quantum field theories, which can be thought of as a collection of particles, or fields, together with a prescription for how these interact with each other. These interactions are typically controlled by a parameter called the *coupling constant* (even though it is generally not a constant, as it depends on the energy at which we study the theory). This parameter determines how strongly the various particles interact. There could of course also be other parameters in the theory, such as masses of particles, sizes of dimensions that the theory lives in and so on. Sometimes when people talk about a theory, they mean one with a fixed value of all these various parameters, while in this thesis we will mainly refer to a theory as the full set, and varying some parameters then might take us to a different regime of the theory. One of the important consequences of having access to dualities is then that they typically allow us to make exact calculations in energy regimes where this would otherwise be impossible.

Duality can, of course, mean many different things, and there exists a large number of different types of dualities in modern physics and mathematics, all important in their own way. Schematically, a duality is the manifestation of the fact that a specific theory might have several alternative descriptions, and that which of these are suitable might vary depending on which regime of the theory we are in. A famous example of duality is the particle/wave duality of quantum physics. This duality says that in a quantum

theory it no longer makes sense to say that a particle is just a particle or a wave. It is in fact both. Sometimes it is better to describe it as a particle while at other times the wave picture is more fruitful. The two descriptions are dual to each other. This notion of duality is, however, very different in nature compared to the ones we will focus on in this thesis, but serves as a good starting point to think about how dualities can work.

Some important examples of dualities in more modern research are: electric/magnetic duality, which states that, in a quantum theory, the electric and magnetic fields behave as dual quantities; the gauge/gravity correspondence, which relates a gravitational theory with a quantum field theory living on the boundary of spacetime; and mirror symmetry, which relates two different types of strings moving in two distinct spaces. A generalisation of electric/magnetic duality will be the main concern of this thesis and will now be described in more detail.

The type of duality that will be most important in this thesis is that of strong/weak duality, or *S-duality*, and how this is manifested in gauge theories. This is a generalisation of the electric/magnetic duality mentioned above. Strong/weak duality relates a weakly coupled description, where quantum effects are small, to a strongly coupled one, where quantum effects are large. This is a very remarkable thing. In general, the strongly coupled region is not accessible for calculations due to the strong quantum effects, but when we have access to S-duality we can make use of the weakly coupled dual description to perform our calculations.

Dualities typically result in non-intuitive behaviour of various objects in our theory. An important example in String theory comes from something called T-duality, which is closely related to mirror symmetry. This duality says that a string moving in a space shaped like a very small circle behaves exactly the same as a different kind of string moving in a space shaped as a very large circle. All the observable features in one description gets mapped to observable features in the dual description. For example, momentum in one description gets mapped to the number of times the string winds around the circle in the other description. Another extraordinary aspect of dualities is that the fundamental objects in one regime may get interchanged with composite objects in the dual. This happens for example in electric/magnetic duality, where the electric field is considered fundamental in one frame and the magnetic field as coming from a composite objects, while in the dual frame we find that the opposite picture is more natural. We are thus left to wonder if there ever was such a thing as a fundamental entity, or if we rather should think of everything as being emergent objects depending solely on which description we decide to use. In other words, dualities throw reductionism – the idea that everything can be reduced to a fundamental entity – out the window.

As we have mentioned above, this thesis will mainly be concerned with studying duality in a certain kind of theories that physicists refer to as gauge theories. The simplest such theory is that of electromagnetism, describing how the electric and

magnetic fields interact with their environment. The generalisation of electromagnetism into something called Yang-Mills theories is the foundation of modern particle physics. Yang-Mills theories serve as the building blocks of the so called Standard model, describing three of the four fundamental interactions of our Universe; the electromagnetic force and the weak and strong nuclear forces, with gravity being the one left out. The S-duality manifests itself in gauge theories by saying that the (analogues of the) electric and magnetic fields are dual quantities. This means that in one regime electrically charged particles look fundamental while in another the magnetically charged particles (usually referred to as monopoles) appears fundamental.

Particles come in two different types, bosons, the mediators of interactions, and fermions, the particles that build up matter. Photons, the quanta of light, are examples of bosons and they are responsible for the interaction of electromagnetism, while electrons, protons and neutrons are examples of fermions. Supersymmetry is a symmetry which relates these two types of particles, i.e., in a supersymmetric theory, each boson is accompanied by a fermion and vice versa, and they further get interchanged by the symmetry. Even though supersymmetry is a theory of tremendous beauty and it would be a sad thing if Nature happened to miss out on it, experimentalists have not been able to observe any supersymmetry as of yet. This, however, does not prevent theorists from incorporating it in theories. S-duality is not expected to hold exactly for generic gauge theories. But adding supersymmetry to the theories places S-duality on a firmer footing and more precise statements can be made, and sometimes even explicitly checked. It is therefore widely believed that certain supersymmetric gauge theories have an exact S-duality built into them. In this thesis, we will study a type of supersymmetric version of Yang-Mills theories, and in particular its low-energy regime. This goes under the name of Seiberg-Witten theories. We will study how duality manifests itself in these types of theories and its resulting consequences.

Fundamental domains for physical parameters

As discussed above, a physical theory typically comes equipped with a number of parameters. These could for example be such quantities as the masses of the particles, or the strength of the interaction between different particles, e.g., the magnitude of their electric charges. One manifestation of dualities is then to relate distinct points in our parameter space by saying that they correspond to the same kind of behaviour for the theory.

A natural question to ask is if we can construct a reduced parameter space that excludes all the values giving equivalent behaviour and only includes a smallest set of values that provides all the distinctly different dynamics. We will refer to such a set as a *fundamental domain* and it will play an important role in this thesis.

For the gauge theories we consider, the relevant parameter is the so called coupling constant. It determines the strength of the interaction between the gauge fields, which are the generalisation of the electric and magnetic fields. In the theory of electromagnetism, for example, this coupling is proportional to the electric charge of the electron.

Among other things, these fundamental domains are very useful when calculating something called *correlation functions*. These are objects that determine the expectation value of a certain event in the theory. To get a better understanding of this we first need to remember that quantum behaviour is strange. Instead of a deterministic theory we are given a probabilistic one, and when we want to calculate the probability of a certain event, say a particle moving from one point to another, we need to sum over all different ways this event can take place. In the example of the motion of a particle this would mean to sum over all possible paths the particle can take, weighted by the probability for each one. This sum is an example of a correlation function typically called the path integral for this event and it is a fundamental tool used for calculations in quantum field theory.

Generally, correlation functions are very hard to compute. In principle they are not even well-defined, since one needs to sum over an infinite amount of possible paths, or values of the coupling constant when dealing with interactions, and this typically leads to unwanted infinite answers. However, it turns out that the correlation functions in certain versions of the gauge theories discussed in this thesis reduce to a smaller sum over the possible values of the coupling constant that belong to the fundamental domains. In addition, we will show that these sums can be simplified even further by using the mathematical theory of *modular forms*. Then the sums become straightforward to carry out.

Outline and summary of the thesis

The thesis is outlined as follows: In Chapter 1 we give a technical introduction to the topics relevant for the thesis. This covers an introduction to the Seiberg-Witten solution of the low-energy effective $SU(2)$ $\mathcal{N} = 2$ supersymmetric Yang-Mills theory. We focus on the presence of modular forms and discuss how the moduli space of vacua can be contained in a modular fundamental domain for the gauge coupling. We further give a brief introduction to topological twisting and how the fundamental domains play an important role when calculating topological correlators in these theories.

The main results of the thesis are contained in Chapters 2-4. In Chapter 2 (based on [2, 3]) we consider the generalisation of the pure $SU(2)$ theory by adding fundamental hypermultiplets. We show that this in general means that the modularity becomes much more subtle due to the introduction of branch points for the order parameter of the moduli space. Despite this drawback, we develop various techniques to study the

moduli space and in particular how we can still construct fundamental domains for the couplings.

In Chapter 3 (based on [1]) we return to the pure theory, but now with gauge group $SU(3)$. The moduli space is then parameterised by two complex functions, which are believed to be related to higher genus modular forms. We discuss how, on certain loci of the moduli space, the order parameters can be related to elliptic modular forms. These loci further capture all the interesting points of the moduli space.

After this, in Chapter 4 (based on [4, 5]), we discuss the construction of topologically twisted versions of the $SU(2)$ theory with fundamental hypermultiplets coupled to background fluxes. The twisting is then labelled by the choice of background flux and the procedure thus gives rise to an infinite family of topological partition functions. We conclude the chapter by an explicit example of how mock modular forms and integration over fundamental domains provides an important tool in the evaluation of correlation functions for these topological theories, but now for the pure theory placed on a non-simply connected manifold, generalising previous recent results on these integrals.

The thesis is concluded with a brief discussion and outlook, Chapter 5, while the appendices A-C give some further technical details on various important topics.

Chapter 1

Duality, domains and Seiberg-Witten theory

In this Chapter we give a brief survey of the background material needed for the analyses of the thesis. We start with the concept of duality in modern gauge theories, and in particular we will focus on how this is manifested in $\mathcal{N} = 2$ supersymmetric Yang-Mills theories. To this end, we will concentrate our discussion on the low-energy effective theories, which are typically referred to as Seiberg-Witten (SW) theories [7, 8]. After this we discuss how to construct fundamental domains for the running coupling of the same gauge theories and give a short introduction to how these domains play an important role when calculating topological correlators.

Four-dimensional $\mathcal{N} = 2$ theories play an important role in theoretical physics, as they are simple enough for us to be able to still make exact statements while complicated enough to host a plethora of interesting phenomena. The study of $\mathcal{N} = 2$ gauge theories has played an important role in our increased understanding of quantum field theory and String theory through, for example, the introduction of new types of superconformal theories [9], geometrical engineering [10], the class S web of dualities [11] and much more. The aim of this thesis is to delve deeper into this rich well by studying various generalisations of the Seiberg-Witten theories and their duality properties.

1.1 Duality in Seiberg-Witten theory

It is hard to overstate the importance of dualities in modern physics. In many cases dualities allow us to probe non-perturbative aspects of theories which would otherwise be beyond our calculational tools. One important example is the Montonen-Olive duality of gauge theories [12]. Seiberg and Witten studied the low-energy effective theory of $\mathcal{N} = 2$ supersymmetric Yang-Mills and were able to show how Montonen-Olive duality generalises to the $\mathcal{N} = 2$ case [7, 8]. They further used this notion of duality to completely solve the effective theory. In this Section we will review the most relevant

aspects of the SW solution, focusing on the pure SU(2) theory (without hypermultiplets). Some excellent reviews on this topic are [13–17].

In the case of the pure SU(2) theory, one manifestation of duality is the fact that the order parameter for the moduli space of vacua is a modular function with well-behaved transformation properties under the duality group. Furthermore, the duality group is a special subgroup of $SL(2, \mathbb{Z})$. An important question, and one that serves as the main topic of this thesis, is how this generalises to more complicated theories. As we will show in Chapter 2, it turns out that the question of modularity is much more subtle in the theories with matter, following from the appearance of branch points in the fundamental domains.

When we go to higher rank gauge groups, as for example SU(N) for $N > 2$, it is expected that the monodromy group will be some subgroup of $Sp(2N - 2, \mathbb{Z})$, and the classical modular forms should be exchanged for higher genus Siegel modular forms [7, 18, 19]. However, the discussion on theories with matter would indicate that also here we should expect branch points appearing and the modular properties to be more subtle. In Chapter 3 we will discuss how certain loci of the moduli space of the pure SU(3) theory can still have fully modular properties, although some new features, such as Fricke involutions, do appear.

1.1.1 Semi-classical analysis of the moduli space

In the seminal papers [7, 8], Seiberg and Witten gave the exact low-energy solution of $\mathcal{N} = 2$ SYM with gauge group SU(2) and either $N_f \leq 4$ fundamental hypermultiplets or one adjoint hypermultiplet. One of the many important results was that they worked out how the action of Montonen-Olive duality generalises in these theories. The structure of the moduli space is naturally captured by introducing an auxiliary family of elliptic curves parameterised by the order parameter of the quantum moduli space. In some cases, most notably the pure SU(2) theory, the moduli space can be described by a modular surface, given by the upper half-plane, \mathbb{H} , modulo the action of a certain subgroup, Γ , of $SL(2, \mathbb{Z})$, or in other words $\Gamma \backslash SL(2, \mathbb{Z})$ [7, 20, 21]. In this introductory Section, we will mostly study the pure SU(2) theory in order to provide the needed background for the later Chapters of the thesis, devoted to generalising this simplest of cases in various directions.

The pure theory contains only a vector multiplet transforming in the adjoint representation of the gauge group. This consists of a gauge field, A_μ , two Weyl fermions, Ψ_α^I , $\bar{\Psi}_{\dot{\alpha}}^I$ and a complex scalar ϕ . The R -symmetry interchanges the two fermions while leaving the bosons invariant. Let us denote the representation under the rotation group, $Spin(4) = SU(2)_+ \times SU(2)_-$, and the SU(2) $_R$ R-symmetry by $(\mathbf{k}, \mathbf{l}, \mathbf{m})$, with \mathbf{k}, \mathbf{l} and \mathbf{m} being the dimensions of the representations. We thus have the representations

$$(\mathbf{2}, \mathbf{2}, \mathbf{1}) \oplus (\mathbf{1}, \mathbf{1}, \mathbf{1}) \oplus (\mathbf{1}, \mathbf{1}, \mathbf{1}), \quad (1.1)$$

for the bosons of the vector multiplet, while the representations for the fermions are

$$(\mathbf{1}, \mathbf{2}, \mathbf{2}) \oplus (\mathbf{2}, \mathbf{1}, \mathbf{2}). \quad (1.2)$$

In this thesis we will also be interested in the case of adding hypermultiplets transforming in the fundamental representation of the gauge group to the theory. The $\mathcal{N} = 2$ hypermultiplet contains two pairs of Weyl fermions, $\lambda_\alpha, \bar{\lambda}_{\dot{\alpha}}, \chi_\alpha$ and $\bar{\chi}_{\dot{\alpha}}$ along with two complex scalars q and \tilde{q} . The $SU(2)_R$ symmetry now interchanges the two scalars and we have the representations

$$(\mathbf{1}, \mathbf{1}, \mathbf{2}) \oplus (\mathbf{1}, \mathbf{1}, \mathbf{2}), \quad (1.3)$$

for the bosonic fields, and

$$(\mathbf{2}, \mathbf{1}, \mathbf{1}) \oplus (\mathbf{1}, \mathbf{2}, \mathbf{1}) \oplus (\mathbf{2}, \mathbf{1}, \mathbf{1}) \oplus (\mathbf{1}, \mathbf{2}, \mathbf{1}), \quad (1.4)$$

for the fermionic fields.

In superspace, we write the Lagrangian for the vector multiplet with gauge group G as [16]

$$\mathcal{L} = \frac{1}{4\pi} \text{Im} \left(\tau \int d^2\theta W^{a\alpha} W_\alpha^a \right) + \int d^2\theta d^2\bar{\theta} \Phi^{\dagger,a} (e^{2V})_{ab} \Phi^b, \quad (1.5)$$

where $a = 1, \dots, \dim G$, $V = V^a T^a$ for T^a in the adjoint representation of G , the chiral superfield

$$\Phi = \phi + \sqrt{2}\theta^\alpha \Psi_\alpha + \theta^2 F, \quad (1.6)$$

the field strengths

$$W_\alpha = -\frac{1}{4} \bar{D}^2 D_\alpha V, \quad D_\alpha = \frac{\partial}{\partial \theta^\alpha} + i \sigma_{\alpha\dot{\alpha}}^\mu \bar{\theta}^{\dot{\alpha}} \partial_\mu, \quad (1.7)$$

and we made use of the standard superspace Berezin integral for each anti-commuting coordinate θ , defined by the relations

$$\int d\theta = 0, \quad \int d\theta\theta = 1. \quad (1.8)$$

The Lagrangian of the hypermultiplets instead reads

$$\mathcal{L} = \int d^2\theta d^2\bar{\theta} (Q^\dagger Q + \tilde{Q}^\dagger \tilde{Q}) - i m \int d^2\theta Q \tilde{Q} + i m \int d^2\bar{\theta} Q^\dagger \tilde{Q}^\dagger, \quad (1.9)$$

where m is the mass parameter and Q, \tilde{Q} are $\mathcal{N} = 1$ chiral multiplets,

$$\begin{aligned} Q &= \tilde{q} + \sqrt{2}\theta^\alpha \lambda_\alpha + \theta^2 F_1, \\ \tilde{Q} &= i \left(q^\dagger + \sqrt{2}\theta^\alpha \chi_\alpha + \theta^2 F_2^\dagger \right), \end{aligned} \quad (1.10)$$

with F_i auxiliary fields [16].

The potential for the scalar fields, ϕ , is given by

$$V(\phi) = \frac{1}{g^2} \text{Tr}[\phi, \phi^\dagger]^2, \quad (1.11)$$

with flat directions given by $[\phi, \phi^\dagger] = 0$. One general solution is to parametrise the vacuum by a complex parameter a

$$\phi = \begin{pmatrix} a & 0 \\ 0 & -a \end{pmatrix}, \quad (1.12)$$

up to gauge transformations. We can note that the Weyl group of $SU(2)$ acts on the scalars by sending $a \rightarrow -a$. Classically, a good local parameter for the moduli space is then given by $u \sim a^2$, which in the quantum theory will become the vacuum expectation value

$$u = \frac{1}{16\pi} \langle \text{Tr}(\phi^2) \rangle_{\mathbb{R}^4}. \quad (1.13)$$

When $a \neq 0$ the gauge group is broken to $U(1)$ and this branch of the moduli space is therefore referred to as the *Coulomb branch*. Sometimes we will also refer to it as the u -plane, since it is parameterised by u . Classically, there is a singularity at $u = 0$ where the gauge group gets restored and additional fields become massless.

The one-loop beta function of $\mathcal{N} = 2$ supersymmetric Yang-Mills theory with $N_f \leq 4$ hypermultiplets in the fundamental representation is $\beta_{N_f}(g_{\text{YM}}) = -\frac{g_{\text{YM}}^3}{16\pi^2}(4 - N_f)$. As is standard, we combine the Yang-Mills coupling with the theta angle to construct the complexified coupling $\tau = \frac{\theta}{\pi} + \frac{8\pi i}{g_{\text{YM}}^2}$. This complexified gauge coupling can be considered as the expectation value of a background chiral superfield. In the renormalisation scheme where the superpotential remains a holomorphic function of all chiral superfields, the one-loop running coupling at the energy scale E can be expressed as [22]

$$\tau(E) = \tau_{\text{UV}} - \frac{4 - N_f}{2\pi i} \log \frac{E}{\Lambda_{\text{UV}}}. \quad (1.14)$$

It is one-loop exact in the holomorphic scheme, and thus for the asymptotically free theories, with $N_f < 4$, the combination

$$\Lambda_{N_f}^{4-N_f} := \Lambda_{\text{UV}}^{4-N_f} e^{2\pi i \tau_{\text{UV}}} \quad (1.15)$$

of the scale Λ_{UV} and the coupling τ_{UV} is invariant to all orders in perturbation theory. This complexified dynamical scale Λ_{N_f} sets the overall scale of the theory. For $N_f = 4$ on the other hand, there is a distinguished dimensionless parameter τ_{UV} , on which the theory depends nontrivially. We further note that, the theta parameter is not running. This is due to its topological nature, meaning that we can express the theta term, locally, as a total derivative [23].

An important fact about $\mathcal{N} = 2$ gauge theories is that, up to two-derivative terms the low-energy dynamics is completely determined by a single holomorphic function, the *prepotential*, F [24]. In terms of this, we can write the effective Lagrangian of the pure theory, (1.5), as

$$\mathcal{L} = \frac{1}{4\pi} \text{Im} \left(\int d^4\theta \frac{\partial F(\Phi)}{\partial \Phi} \bar{\Phi} + \int d^2\theta \frac{1}{2} \frac{\partial^2 F}{\partial \Phi^2} W^\alpha W_\alpha \right). \quad (1.16)$$

Semi-classically, the prepotential of the pure theory is given by [7, 25–28]

$$F(a) = \frac{2i}{\pi} a^2 \log(a/\Lambda_0) + \dots, \quad (1.17)$$

where further non-perturbative corrections are suppressed. The running coupling τ can locally be expressed in terms of the prepotential as $\frac{\partial^2 F}{\partial a^2}$.

When we go to the quantum theory, the moduli space will be complex Kähler and the metric can locally, for large a , be written as [7]

$$ds^2 = \text{Im}(\tau) da d\bar{a}. \quad (1.18)$$

We can further introduce an extra parameter $a_D = \frac{\partial F}{\partial a}$ such that the metric can be written

$$ds^2 = \text{Im} da_D d\bar{a} = \frac{i}{2} (da d\bar{a}_D - da_D d\bar{a}). \quad (1.19)$$

We see that this is completely symmetric upon interchanging a and a_D . It turns out that, physically, a_D plays an important role as the good local coordinate in the dual coupling regime, i.e., it is the magnetic dual of a . Due to the symmetry of (1.19) we therefore expect this expression for the metric to be valid in both coupling regimes, where either a or a_D act as the good local coordinate. It follows that, in the a_D regime we can again write it in the form (1.18), with a_D interchanging a and the dual coupling τ_D taking the role of τ . We can note that the metric (1.19) is generically invariant under transformations

$$\begin{pmatrix} a_D \\ a \end{pmatrix} \mapsto M \begin{pmatrix} a_D \\ a \end{pmatrix} + c, \quad (1.20)$$

for a constant vector c and $M \in \text{SL}(2, \mathbb{R})$. Some important aspects of the group $\text{SL}(2, \mathbb{R})$ and its discrete analogue, $\text{SL}(2, \mathbb{Z})$, are discussed in Appendix A. Later, we will see that c must be equal to the zero vector in the pure theory while it plays an important role in the theories with hypermultiplets. The physical interpretation of the action of $\text{SL}(2, \mathbb{R})$ on the metric, is exactly that of duality. As mentioned in Appendix A, $\text{SL}(2, \mathbb{R})$ is generated by the generators T_t and S ,

$$T_t = \begin{pmatrix} 1 & t \\ 0 & 1 \end{pmatrix}, \quad S = \begin{pmatrix} 0 & -1 \\ 1 & 0 \end{pmatrix}, \quad t \in \mathbb{R}. \quad (1.21)$$

The action of T_t is simply to shift the theta angle in τ by a number

$$T_t : \theta \mapsto \theta + \pi t \quad \text{or} \quad \tau \mapsto \tau + t. \quad (1.22)$$

When we consider the introduction of non-trivial $U(1)$ bundles, e.g., magnetic monopoles, the allowed shifts in θ are only integer multiples of π . The group is thus reduced to $SL(2, \mathbb{Z})$. The action of the S -transformation is to interchange the roles of a and a_D ,

$$S : \begin{pmatrix} a_D \\ a \end{pmatrix} \mapsto \begin{pmatrix} a \\ -a_D \end{pmatrix}. \quad (1.23)$$

This has the action of the electric-magnetic duality transformation. Since $\tau = \frac{\partial^2 F}{\partial a^2} = \frac{\partial a_D}{\partial a}$ it sends

$$S : \quad \tau \mapsto -\frac{1}{\tau} =: \tau_D. \quad (1.24)$$

This dual coupling will thus be the one appearing in the dual expression of the metric (1.18) in the a_D frame. It is important to stress here that, although we expect the shift of the theta term by an integer multiple of π to be a true symmetry of the theory, i.e., the physics should be completely invariant under this action, the same is not true for the S -transformation. The transformation is rather a map between two different descriptions of the same theory. For certain theories, like $\mathcal{N} = 4$ SYM and $\mathcal{N} = 2$ with four fundamental flavours it is believed that the theory is completely invariant under this change of reference frame [12, 29]. But in the more generic $\mathcal{N} = 2$ theories this is not the case and we simply have the above duality transformation as an important tool for performing calculations in different duality frames.

When we have extended supersymmetry, such as $\mathcal{N} = 2$, an important object is the central charge, Z . This is the centre of the supersymmetry algebra and is defined by the relation

$$\{\mathcal{Q}_\alpha^I, \mathcal{Q}_\beta^J\} = 2\epsilon_{\alpha\beta} Z^{IJ} \quad Z^{IJ} = -Z^{JI}, \quad I, J = 1, \dots, \mathcal{N}, \quad (1.25)$$

where the \mathcal{Q} s are the supercharges and for $\mathcal{N} = 2$ we set $Z^{12} = Z$. Unitary representations of the $\mathcal{N} = 2$ supersymmetry algebra demands that the mass is bounded by the central charge as

$$M \geq |Z|. \quad (1.26)$$

The states that saturate this bound are called BPS states and play a central role in the theory [30, 31].

Having identified a_D with the magnetic dual of a we can express the central charge of a dyonic state with charge (p, q) as

$$Z = qa + pa_D. \quad (1.27)$$

As mentioned above, a BPS particle has $|Z| = M$. This must also be left invariant under the transformations (1.20). Now, (p, q) are of course integers, so we again see that we must restrict the transformations to lie in $\text{SL}(2, \mathbb{Z})$. Furthermore Z is not invariant under the constant shift c so we must also demand that $c = 0$, at least in the pure theory. In the theory with hypermultiplets the expression for the central charge changes slightly to account for flavour charges and the story gets modified, as we will discuss in Chapters 2 and 4. In the following we will see that the theory is not left invariant by the whole group $\text{SL}(2, \mathbb{Z})$ but only a certain subgroup.

From (1.17), we find the semi-classical behaviours

$$\begin{aligned} a &= \sqrt{\frac{u}{2}} + \dots, \\ a_D &= \frac{4i}{\pi} a \log \frac{a}{\Lambda_0} + \frac{2i}{\pi} a + \dots \end{aligned} \tag{1.28}$$

Encircling infinity, by sending $u \rightarrow e^{2\pi i} u$, we thus find a monodromy action on the periods

$$M_\infty = PT^{-4} = \begin{pmatrix} -1 & 4 \\ 0 & -1 \end{pmatrix}, \quad \begin{pmatrix} a_D \\ a \end{pmatrix} \mapsto M_\infty \begin{pmatrix} a_D \\ a \end{pmatrix}, \tag{1.29}$$

where $P = S^2$. We see that the periodicity of the quantum theory at weak coupling is given by $\tau \rightarrow \tau + 4$. This widening of the periodicity, compared to the classical $\tau \mapsto \tau + 1$ periodicity of the theta angle, can be understood from the Witten effect by considering the electric charge of the magnetic monopole at weak coupling [32, 7].

Having a monodromy around infinity implies that there should be one also for the other singularities. We saw that classically there is only one other singularity, at $u = 0$, but quantum mechanically we expect this to split into at least two. To see this, we note that if there was only one, we would need the monodromy around the strong coupling singularity to be equal to the one at infinity and the fundamental group of the moduli space would be Abelian. This, however, implies that a would be a good *global* coordinate which would give a generically non-positive metric, (1.18). The minimal resolution, which turns out to be the good one, is that the classical singularity splits into two when going to the quantum theory. There is also a \mathbb{Z}_2 symmetry acting on the moduli space as $u \rightarrow -u$ and the singularities should therefore be related by a sign, and we should thus have two singularities located at $u = \pm u_0 \neq 0$. Working under this assumption we know that we must have $M_\infty = M_{u_0} M_{-u_0}$, since the topology of the path around infinity is the same as that encircling the two strong coupling points consequently.

The most natural physical interpretation of singularities in the moduli space of the low-energy effective theory is as points where extra fields become massless and the low-energy description breaks down. It further turns out that in $\mathcal{N} = 2$ theories this should be a BPS hypermultiplet [7]. In the semi-classical approximation the only

existing ones are the monopole and the dyon. From the central charge formula we then know that the monopole becomes massless at $a_D = 0$ while more generally a (p, q) -dyon becomes massless when $pa_D + qa = 0$.

Let us denote the point where a monopole becomes massless as u_0 . To analyse the behaviour around this point, we perform a duality transformation. This means that we express the Lagrangian in terms of dual variables. From the one-loop beta function and the fact that a_D is the good local parameter near this point we find that

$$\begin{aligned} a_D &\sim c_0(u - u_0) + \dots, \\ a &\sim a_0 + \frac{i}{2\pi} c_0(u - u_0) \log\left(\frac{u - u_0}{\Lambda_0^2}\right) + \dots, \end{aligned} \quad (1.30)$$

for some constants c_0 and a_0 . Encircling this singularity, we now find the monodromy

$$M_{u_0} = STS^{-1} = \begin{pmatrix} 1 & 0 \\ -1 & 1 \end{pmatrix}, \quad \begin{pmatrix} a_D \\ a \end{pmatrix} \mapsto M_{u_0} \begin{pmatrix} a_D \\ a \end{pmatrix}. \quad (1.31)$$

Note that, in contrast to the duality transformation S , this monodromy transformation is a symmetry of the quantum theory. By a standard abuse of notation we will sometimes refer to the group generated by the monodromy matrices, or more generally the symmetry group of u , as the *duality group* of the theory.

With two of the monodromies determined we can solve for the third one, the result is

$$M_{-u_0} = T^2 STS^{-1} T^{-2} = \begin{pmatrix} -1 & 4 \\ -1 & 3 \end{pmatrix}, \quad (1.32)$$

and this is consistent with having a dyon of charge $(1, 2)$ becoming massless. We thus have a set of three monodromy matrices, T^4 , STS^{-1} and $T^2 STS^{-1} T^{-2}$. Together, these only generate a subgroup of $\mathrm{SL}(2, \mathbb{Z})$, namely the congruence subgroup $\Gamma^0(4) \subset \mathrm{SL}(2, \mathbb{Z})$. See Appendix A for further details on subgroups of $\mathrm{SL}(2, \mathbb{Z})$. This group is then what we will refer to as the duality group of the pure $\mathrm{SU}(2)$ SW theory.

An important aspect of when we add hypermultiplets to the $\mathrm{SU}(2)$ theory is that additional singularities will appear in the effective theory. These correspond to the points where elementary quarks become massless. The mass of the elementary quark is given by $|\sqrt{2}a - m_i|$, where the m_i are the mass parameter of the hypermultiplet, and the extra singularity thus appears at $a = \frac{m_i}{\sqrt{2}}$ [8].

1.1.2 Introducing the Seiberg-Witten curve

Now, the important insight of Seiberg and Witten was that all of the above structures of the moduli space can be captured by introducing an auxiliary family of elliptic curves (or higher genus curves for higher rank gauge groups [33, 34]), parametrised by u [7, 8]. The scalar field, a , and its dual, $a_D = \frac{\partial F}{\partial a}$, are then given as integrated periods of these

elliptic curves

$$a = \int_A \lambda_{\text{SW}}, \quad a_D = \int_B \lambda_{\text{SW}}, \quad (1.33)$$

where A and B comprise a canonical basis for the homology cycles on the elliptic curve and λ_{SW} is a certain meromorphic differential called the Seiberg-Witten differential. This can be determined uniquely by matching with the asymptotic behaviours. The complex structure of the elliptic curve is further equated with the physical coupling τ , and we have $\tau = \frac{\partial a_D / \partial u}{\partial a / \partial u}$ which agrees with our previous formulas. The singular points of the family of curves, where the elliptic curve degenerates, correspond to the singularities in the moduli space.

The Seiberg-Witten curve of the pure theory is

$$y^2 = x^3 - ux^2 + \frac{1}{4}\Lambda_0^4 x, \quad (1.34)$$

and the SW differential can be chosen as

$$\lambda_{\text{SW}} = \frac{1}{2\sqrt{2\pi}} \frac{y dx}{x^2 - 1}. \quad (1.35)$$

It is easy to check that this gives the right leading behaviour for a and a_D (1.28). For this curve the two strong coupling singularities appear at $u = \pm\Lambda_0^2$.

The parameters a and a_D form a system of solutions to a Picard-Fuchs type equation and can, in the pure theory, be expressed in terms of hypergeometric functions [35]

$$\begin{aligned} a_D(u) &= \frac{i}{2}(u-1) {}_2F_1\left(\frac{1}{2}, \frac{1}{2}, 2; \frac{1-u}{2}\right), \\ a(u) &= \sqrt{\frac{u+1}{2}} {}_2F_1\left(-\frac{1}{2}, \frac{1}{2}, 1; \frac{2}{1+u}\right). \end{aligned} \quad (1.36)$$

An important quality of elliptic curves is that they can all be written in the Weierstraß form

$$\mathcal{W}: \quad y^2 = 4x^3 - g_2x - g_3, \quad (1.37)$$

for some functions g_2 and g_3 . This is further discussed in Chapter 2 and Appendix A. The transformation that takes the SW curve (1.34) to this form is to shift $x \rightarrow x + \frac{u}{3}$ and $y \rightarrow y/2$. After this we can calculate g_2 and g_3 as functions of u and the scale Λ_0 . From this we can then further calculate the SW \mathcal{J} -invariant

$$\mathcal{J}_0(u, \Lambda_0) = \frac{64(3\Lambda_0^4 - 4u^2)^3}{\Lambda_0^8(\Lambda_0^4 - u^2)}. \quad (1.38)$$

The modular j -invariant can be related to Jacobi theta functions, defined in Appendix B, through the identity (B.12),

$$j = 256 \frac{(\vartheta_3^8 - \vartheta_3^4 \vartheta_4^4 + \vartheta_4^8)^3}{\vartheta_2^8 \vartheta_3^8 \vartheta_4^8}. \quad (1.39)$$

Since the Seiberg-Witten solution is to equate the complex structure of the elliptic curve with the physical coupling we should further equate $\mathcal{J}(u, \Lambda_0)$ with $j(\tau)$. This allows to solve for $u(\tau)$,

$$u(\tau) = -\frac{1}{2} \frac{\vartheta_2(\tau)^4 + \vartheta_3(\tau)^4}{\vartheta_2(\tau)^2 \vartheta_3(\tau)^2} = -\frac{\Lambda_0^2}{8} \left(q^{-1/4} + 20q^{1/4} - 62q^{3/4} + \mathcal{O}(q^{5/4}) \right), \quad (1.40)$$

where $q = e^{2\pi i \tau}$. Using the formulas of Appendix B it is easy to check that this is invariant under the two transformations T^4 and STS^{-1} , generating the congruence subgroup $\Gamma^0(4)$. We thus see that the modular structure of $u(\tau)$ captures the duality group exactly. When we move on to more complicated theories in Chapter 2 we will see that this is not the generic case. In general, $u(\tau)$ will turn out to not be invariant under any subgroup of $\text{SL}(2, \mathbb{Z})$. We will discuss many of these subtleties in the coming Chapters. The function (1.40) is sometimes called the McKay-Thompson series of class 4C for the Monster group in the literature [36].

We can perform the duality transformation $\tau \mapsto \tau_D = -\frac{1}{\tau}$ to get the expression for u close to the monopole point ($q_D = e^{2\pi i \tau_D}$)

$$u(\tau_D) = -\frac{\Lambda_0^2}{2} \frac{\vartheta_3(\tau_D)^4 + \vartheta_4(\tau_D)^4}{\vartheta_3(\tau_D)^2 \vartheta_4(\tau_D)^2} = -\Lambda_0^2 - 32\Lambda_0^2 q_D^2 + \mathcal{O}(q_D^2). \quad (1.41)$$

We thus see that when $\tau_D \rightarrow i\infty$, or $\tau \rightarrow 0$, we approach the singularity $u = -\Lambda_0^2$. Similarly, in terms of the dual coupling near the dyon point $\tau_{D,2} := \frac{1}{2-\tau}$ we have ($q_{D,2} = e^{2\pi i \tau_{D,2}}$)

$$u(\tau_{D,2}) = \frac{\Lambda_0^2}{2} \frac{\vartheta_3(\tau_{D,2})^4 + \vartheta_4(\tau_{D,2})^4}{\vartheta_3(\tau_{D,2})^2 \vartheta_4(\tau_{D,2})^2} = \Lambda_0^2 + 32\Lambda_0^2 q_{D,2}^2 + \mathcal{O}(q_{D,2}^2). \quad (1.42)$$

After this brief introduction to Seiberg-Witten theory we will discuss how to construct fundamental domains for modular functions and how these domains can be used when calculating topological correlators.

1.2 Construction and application of fundamental domains

Having introduced the basic ingredients of SW geometry we can now discuss how to constrain the moduli space of the running coupling, τ , to a fundamental domain parametrising the inequivalent dynamics. In this Section we will only discuss the simple case of having a modular surface, whereby we mean that the duality group is a congruence subgroup of the modular group $\text{SL}(2, \mathbb{Z})$. The main topic of Chapter 2 will be to generalise this in more complicated theories. After this, we will discuss

an application of the fundamental domains as integration domains when calculating correlation functions in a topologically twisted version of the theory.

1.2.1 Constructing fundamental domains for modular surfaces

As we have been discussing, duality and symmetry plays an important role in SW theories. These are encoded in the monodromy transformations of the periods of the SW curve as in (1.29). For the pure theory we saw that these transformations generated the group $\Gamma^0(4)$. The question that we now want to ask is: given these symmetries, can we construct a minimal domain for τ such that it contains all distinct dynamics only once? This is equivalent to saying that we want to consider the domain of the coupling modulo the action of the duality group, i.e., we are interested in the domain

$$\mathcal{F}_0 = \Gamma^0(4) \backslash \mathbb{H}. \quad (1.43)$$

To see how this works, let us start with a simpler example. That of the full group $\mathrm{SL}(2, \mathbb{Z})$. As discussed in Appendix A, the j -invariant is the classical invariant function of $\mathrm{SL}(2, \mathbb{Z})$, or what is typically called a Hauptmodul for $\mathrm{SL}(2, \mathbb{Z})$. We further know that $\mathrm{SL}(2, \mathbb{Z})$ is generated by the transformations S and T , which sends $\tau \mapsto -\frac{1}{\tau}$ and $\tau \mapsto \tau + 1$, respectively. See Appendix A for more details. The second symmetry means that we can restrict to a smallest set for the real part of τ as $-\frac{1}{2} \leq \mathrm{Re} \tau < \frac{1}{2}$ and identify the points along the boundary $\mathrm{Re} \tau = \frac{1}{2}$. We further note that the S transformation reflects around the unit circle, i.e. points with $|\tau| < 1$ gets mapped to points with $|\tau| > 1$. Combining these two statements we thus find that a fundamental domain of $\mathrm{SL}(2, \mathbb{Z})$, $\mathcal{F} = \mathrm{SL}(2, \mathbb{Z}) \backslash \mathbb{H}$, can be chosen as that of Figure 1.1. We will sometimes refer to this as the key-hole fundamental domain. This is then furthermore the fundamental domain of the j -invariant, or in other words, the function $j : \mathcal{F} \rightarrow \mathbb{C}$ is a bijective map.

We can use the exact same argument to construct a fundamental domain for $\Gamma^0(4)$. We saw that the cusp at infinity should have width four while the two strong coupling cusps should both have width one, and be separated by the action of T^2 . This gives the domain in Fig. 1.2. The cusp at $\tau = 0$ corresponds to the monopole point while $\tau = 2$ is the dyon point.

A natural question to ask, and one that is at the core of the rest of this thesis, is now what happens when we generalise the theory in various directions, for example by adding matter. This will be the topic of Chapter 2. The short answer is that, generically, the above will no longer be true. I.e., the correspondence between the duality group and a congruence subgroup of $\mathrm{SL}(2, \mathbb{Z})$ can no longer be made. At least not as an action through fractional linear transformations on the coupling. The reason for this is that the order parameters, as well as other important functions, now have branch points as a function of τ . This will introduce new subtleties when thinking about the monodromies. It further means that the fundamental domains of the running couplings will generally

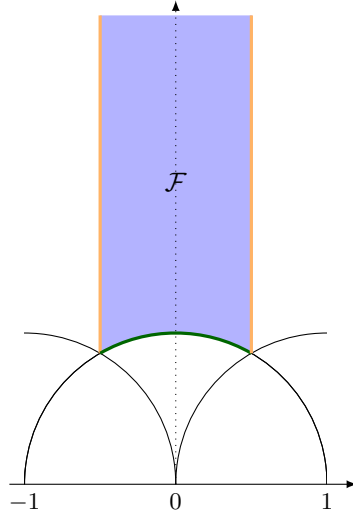

Fig. 1.1 The key-hole fundamental domain \mathcal{F} of $\mathrm{SL}(2, \mathbb{Z})$. The boundaries of the same colour are identified. The two halves of the green semi-arc are identified in opposite directions.

not correspond to those of any subgroup of $\mathrm{SL}(2, \mathbb{Z})$. Despite this complication, we will discuss how fundamental domains can still be constructed in a way similar to the above discussion. The same statement is expected to hold also for more complicated gauge groups, where the monodromies typically generate some subgroup of $\mathrm{Sp}(2r, \mathbb{Z})$, where r is the rank of the gauge group. See Chapter 3 for a discussion on this.

1.2.2 Topological twisting

An interesting application of the fundamental domains for the running coupling comes when calculating topological correlators of topologically twisted versions of the $\mathcal{N} = 2$ gauge theories. This will be analysed in much more detail in Chapter 4. The topologically twisted gauge theories were first introduced by Witten [37]. There exists many different versions of topological twisting [29, 37–39], but in four-dimensional $\mathcal{N} = 2$ supersymmetric gauge theory we only have one possibility, this is referred to as the Donaldson-Witten twist.

Let us sketch how the twisting procedure works. We first consider the global symmetry group of the $\mathcal{N} = 2$ supersymmetric theory. This is the combination of the four-dimensional rotational group, $\mathrm{Spin}(4) \cong \mathrm{SU}(2)_+ \times \mathrm{SU}(2)_-$, with the internal R -symmetry group, $\mathrm{SU}(2)_R \times \mathrm{U}(1)_R$. The generators of the rotational group, $M_{\mu\nu}$, can be written in spinorial form as

$$M_{\mu\nu} \rightarrow M_{\alpha\dot{\alpha},\beta\dot{\beta}} = \epsilon_{\alpha\beta}\bar{M}_{\dot{\alpha}\dot{\beta}} + \epsilon_{\dot{\alpha}\dot{\beta}}M_{\alpha\beta}, \quad (1.44)$$

where $M_{\alpha\beta}$ generates $\mathrm{SU}(2)_-$ and $M_{\dot{\alpha}\dot{\beta}}$ generates $\mathrm{SU}(2)_+$ and $\epsilon_{\alpha\beta}$ is the $\mathrm{SL}(2, \mathbb{C})$ invariant tensor [16]. The idea of the Donaldson-Witten twist is to introduce a new rotational

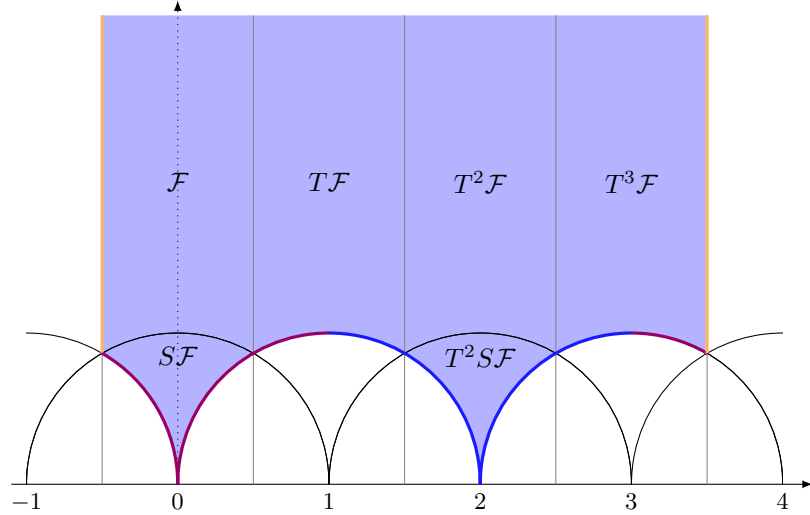

Fig. 1.2 Fundamental domain of $\Gamma^0(4)$. This is the duality group of the pure $SU(2)$ theory. The two cusps on the real line correspond to the strong coupling singularities of the gauge theory, while the cusp at $\tau = i\infty$ corresponds to weak coupling. The boundaries are identified according to colour.

group $SU(2)'_+ \times SU(2)_-$, where we identify $SU(2)'_+$ with the diagonal subgroup of $SU(2)_+ \times SU(2)_R$. The new group is then generated by

$$M'_{\dot{\alpha}\dot{\beta}} = M_{\dot{\alpha}\dot{\beta}} - R_{\dot{\alpha}\dot{\beta}}, \quad (1.45)$$

where $R_{\dot{\alpha}\dot{\beta}}$ are the generators of the $SU(2)_R$ symmetry. With respect to this new group, we now have a scalar supercharge

$$\mathcal{Q} := \epsilon^{\dot{\alpha}\dot{\beta}} \bar{\mathcal{Q}}_{\dot{\alpha}\dot{\beta}}, \quad (1.46)$$

and by studying the supersymmetry algebra we find that $\mathcal{Q}^2 = 0$, i.e., \mathcal{Q} is a nilpotent operator. For this reason, operators that are \mathcal{Q} -exact will decouple from the theory, and the remaining observables will be the \mathcal{Q} -invariant operators [16]. This gives rise to the name *cohomological quantum field theory* sometimes used to refer to this kind of topological quantum field theory. The reason for these theories being referred to as topological is that the stress tensor becomes \mathcal{Q} -exact after the twist and correlators of \mathcal{Q} -invariant operators will therefore be metric independent [37]. See Sec. 4.3.

In Section 4.2.2 we will discuss some subtleties that arise when twisting a theory with fundamental hypermultiplets, as well as how this can be resolved by coupling the theory to extra background fluxes. The topologically twisted theories will then be labelled by a choice of flux and this gives rise to an infinite family of topological partition functions.

1.2.3 Integrating over fundamental domains

Once we have performed the topological twist we can study the Seiberg-Witten theory on a generic four-manifold and moreover calculate topological correlators. The Coulomb branch path integral of the topologically twisted theory vanishes for four-manifolds with $b_2^+ > 1$ [40]. This is schematically because there are then too many fermion zero modes present. See [40] for a detailed analysis. Since we will only be interested in the contribution from this branch, we restrict the analysis of this thesis to compact, oriented four-manifolds with $b_2^+ = 1$. The path integral will also contribute for manifolds with $b_2^+ = 0$, but much less is known about this case, and we leave that as an interesting future research direction. Chapter 4 will be devoted to explicitly constructing the topological correlators as integrals over the u -plane. In this Section we will therefore only give a schematic introduction to how these integrals look and how we can use the knowledge gained in previous Sections to integrate over the cusps of the fundamental domain.

It is worth mentioning, although we will not focus on it in this thesis, that for the pure SU(2) theory the topological correlators for surface observables are related to the famous Donaldson invariants of four-manifolds. Namely, the contribution from the Coulomb branch integral together with the Seiberg-Witten contribution gives the Donaldson invariants [41].

The integral over the Coulomb branch, \mathcal{B} , or u -plane, is the path integral of the low-energy U(1) theory with insertions from observables. Schematically, it takes the form

$$\Phi = \int_{\mathcal{B}} da \wedge d\bar{a} \rho(a) \Psi(a, \bar{a}), \quad (1.47)$$

where $\rho(a)$ is a function containing the couplings to the background and $\Psi(a, \bar{a})$ is the photon partition function, a sum over the fluxes of the unbroken U(1) [42, 40]. For the topologically twisted pure theory there are no further restrictions regarding which four-manifold the twisted theory can be formulated on, while the presence of hypermultiplets introduces some subtleties, discussed in Chapter 4. In the above expression we have not included any observables, for simplicity.

By changing integration variables from the local coordinates a and \bar{a} to the couplings τ and $\bar{\tau}$ the integration domain becomes that of the fundamental domain of the coupling [40]. Armed with this knowledge, recent progress has been made on the explicit evaluation of these integrals by using the theory of mock modular forms [43–47]. The realisation in [43] was that the integrand can be rewritten as a total derivative of a mock modular form. Stokes theorem then tells us that we can rewrite this as an integral over just the boundaries of this domain. Due to the various identifications along these boundaries, as in Fig. 1.2, only the contributions from the cusps will contribute to the u -plane integral. In Chapter 4 we will generalise these recent results by first constructing the integral for the theories with $N_f \leq 3$ fundamental hypermultiplets,

also discussing additional couplings to background fluxes. Furthermore, in Section 4.6 we generalise the previous analysis of [43, 46] for the pure theory to include non-simply connected four-manifolds. As an explicit example of how to evaluate the u -plane integral using mock modular forms we then consider the pure theory on a specific class of such four-manifolds.

Chapter 2

Cutting and gluing with running couplings

We are now ready to leave the safe harbour that is the pure $SU(2)$ SW theory and start analysing the more general theories. To this end, we will start by considering what happens to the modular properties when adding massive hypermultiplets to the $SU(2)$ theory. The modular behaviour of these theories turn out to be much more subtle than for the pure theory, and new interesting phenomena such as superconformal fixed points and branch points arise. In Section 2.1 we consider adding $1 \leq N_f \leq 3$ fundamental hypermultiplets to the theory. Sometimes we will refer to the theories with fundamental hypermultiplets as $\mathcal{N} = 2$ supersymmetric quantum chromodynamics, or SQCD for short. We develop tools for analysing the moduli space and construct fundamental domains for the theories with generic masses, even though the duality group in general is not that of a subgroup of $SL(2, \mathbb{Z})$. The modular properties of the massless theories, as well as for some special fixed values of the masses, have been analysed previously [20, 21, 48]. As an illuminating example Section 2.2 considers the theory with two massive hypermultiplets in detail. Sections 2.1 and 2.2 are based on the paper [2], where also the cases of $N_f = 1$ and $N_f = 3$ are analysed in detail. We, however, omit these two cases here for brevity. The case of adding four fundamental hypermultiplets is somewhat special. For example, the massless limit gives a superconformal theory, and there are some new phenomena arising due to this fact. Sec. 2.3, based on the paper [3], is devoted to the analysis of this theory.

2.1 Massive fundamental hypsers

To list the SW curves of the theories with $1 \leq N_f \leq 3$ hypermultiplets, let Λ_{N_f} be the scale of the theory with N_f hypermultiplets, and m_j , $j = 1, \dots, N_f$ be the masses of

the hypermultiplets. The SW curves of the theories are given by [8]

$$\begin{aligned}
N_f = 1: \quad y^2 &= x^2(x - u) + \frac{1}{4}m\Lambda_1^3x - \frac{1}{64}\Lambda_1^6, \\
N_f = 2: \quad y^2 &= (x^2 - \frac{1}{64}\Lambda_2^4)(x - u) + \frac{1}{4}m_1m_2\Lambda_2^2x - \frac{1}{64}(m_1^2 + m_2^2)\Lambda_2^4, \\
N_f = 3: \quad y^2 &= x^2(x - u) - \frac{1}{64}\Lambda_3^2(x - u)^2 - \frac{1}{64}(m_1^2 + m_2^2 + m_3^2)\Lambda_3^2(x - u) \\
&\quad + \frac{1}{4}m_1m_2m_3\Lambda_3x - \frac{1}{64}(m_1^2m_2^2 + m_2^2m_3^2 + m_1^2m_3^2)\Lambda_3^2.
\end{aligned} \tag{2.1}$$

The family of SW curves are Jacobian rational elliptic surfaces with singular fibres [49–52]. Rational in this context means that g_2 and g_3 are polynomials in u of degree at most 4 and 6, respectively [53].

Decoupling a hypermultiplet corresponds to the following double scaling limit [54]

$$m_j \rightarrow \infty, \quad \Lambda_{N_f} \rightarrow 0, \quad m_j \Lambda_{N_f}^{4-N_f} = \Lambda_{N_f-1}^{4-(N_f-1)} \tag{2.2}$$

One can directly decouple more than one hypermultiplet, where the scales of the low energy theories are defined as

$$\Lambda_0^2 = m\Lambda_2, \quad \Lambda_0^4 = m^3\Lambda_3, \quad \Lambda_1^3 = m^2\Lambda_3, \tag{2.3}$$

and m is the equal mass of the hypermultiplets being decoupled.

The SW curves are constructed in such a way that their mathematical discriminants, see Appendix A, will, up to an overall normalisation, correspond to the *physical discriminant*. This we define as the monic polynomial,

$$\Delta_{N_f} := \prod_{i=1}^{N_f+2} (u - u_i), \tag{2.4}$$

with u_i being the singular points of the effective theory, where hypermultiplets become massless. It is a polynomial of degree $\deg \Delta_{N_f} = N_f + 2$ in u . To see this, we bring the SW curves into Weierstraß form by shifting $x \rightarrow x + \frac{u}{3} + \frac{\Lambda_3^2}{192}\delta_{3,N_f}$, and rescaling $y \rightarrow y/2$,

$$\mathcal{W}: \quad y^2 = 4x^3 - g_2x - g_3, \tag{2.5}$$

where $g_2 = g_2(u, \mathbf{m}, \Lambda_{N_f})$ and $g_3 = g_3(u, \mathbf{m}, \Lambda_{N_f})$ are polynomials in u , $\mathbf{m} = (m_1, \dots, m_{N_f})$ and the scale Λ_{N_f} . The discriminant Δ_{N_f} is unchanged for this change of variables, and equals

$$\Delta_{N_f} = (-1)^{N_f} \Lambda_{N_f}^{2N_f-8} (g_2^3 - 27g_3^2), \tag{2.6}$$

where the last factor is the “mathematical” discriminant, of the modular Weierstraß curve, (A.10). The invariant $\mathcal{J}(u, \mathbf{m}, \Lambda_{N_f})$ can be constructed from g_2 and g_3 same as

before,

$$\mathcal{J} = 12^3 \frac{g_2^3}{g_2^3 - 27g_3^2}. \quad (2.7)$$

Since $g_2(u, \mathbf{m}, \Lambda)$ and $g_3(u, \mathbf{m}, \Lambda)$ are polynomial functions of u , \mathbf{m} and Λ for the SW curves, \mathcal{J} is naturally a rational function $\mathcal{J}(u, \mathbf{m}, \Lambda)$ of these variables. On the other hand, the modular Weierstraß form expresses \mathcal{J} in terms of the complex structure τ , namely as the modular j -invariant $j(\tau)$ (2.7). Since two elliptic curves are isomorphic if and only if their corresponding \mathcal{J} -invariants are equal, this means that we can demand

$$\mathcal{J}(u, \mathbf{m}, \Lambda) = j(\tau). \quad (2.8)$$

This then allows to obtain u as function of τ , which is physically the effective coupling constant. Cusps are points where $j(\tau) = \infty$, which correspond to $\tau \in \{i\infty\} \cup \mathbb{Q}$.

2.1.1 Partitioning the upper half-plane

We are interested in determining the fundamental domains \mathcal{F}_{N_f} for the effective coupling τ for a theory with $1 \leq N_f < 4$. Let us consider u as a function,

$$u : \mathbb{H} \longrightarrow \mathcal{B}_{N_f}, \quad (2.9)$$

and study the analytic properties of this map. We will discuss later the dependence of \mathcal{F}_{N_f} on the masses \mathbf{m} , which we will make manifest in the notation as $\mathcal{F}_{N_f}(\mathbf{m})$ or more compactly $\mathcal{F}(\mathbf{m})$. We find that for $N_f \geq 1$ and generic masses the duality group does not act on τ by fractional linear transformations. This prevents us from defining a fundamental domain as is customary for a congruence subgroup Γ of $\mathrm{SL}(2, \mathbb{Z})$: For any point $\tau \in \mathbb{H}$ there exists a $g \in \Gamma$ such that $g \cdot \tau \in \Gamma \backslash \mathbb{H}$, and no two distinct points τ, τ' in $\Gamma \backslash \mathbb{H}$ are equivalent to each other under Γ . Rather, we can compare if points τ, τ' are equivalent under (2.9): If we define the equivalence relation

$$\tau \sim \tau' \iff u(\tau) = u(\tau'), \quad (2.10)$$

then the quotient set \mathbb{H}/\sim is a fundamental domain \mathcal{F}_{N_f} for the function u . Upon plotting \mathcal{F}_{N_f} as a domain in \mathbb{H} , we will have to introduce identifications along co-dimension 1 segments as for \mathcal{F} of $\mathrm{SL}(2, \mathbb{Z})$ in Figure 1.1.

To determine \mathcal{F}_{N_f} , we take the equation (2.7) for the j -invariant and bring it into a more convenient form. We multiply (2.7) by Δ_{N_f} and bring all terms to one side. This gives the polynomial,

$$\begin{aligned} P_{N_f}(X) &:= \left(g_2(X, \mathbf{m}, \Lambda)^3 - 27g_3(X, \mathbf{m}, \Lambda)^2 \right) j - 12^3 g_2(X)^3 \\ &= a_6 X^6 + a_5 X^5 + \dots + a_1 X + a_0, \end{aligned} \quad (2.11)$$

where the coefficients $a_i = a_i(\mathbf{m}, \Lambda, j)$ are polynomial functions of \mathbf{m} , Λ , and the j function, $a_i(\mathbf{m}, \Lambda, j) \in \mathbb{C}[\mathbf{m}, \Lambda, j]$. The polynomials (2.11) can thus be viewed as polynomials over the field $\mathbb{C}[\mathbf{m}, \Lambda, j]$.

We see that (2.7) is equivalent to $P_{N_f}(u) = 0$ for $\Delta_{N_f} \neq 0$, or in other words, away from the singular locus of the theory. The roots of P_{N_f} can therefore be identified with the order parameter of the corresponding SW curve. Recall that we can assign $U(1)_{\mathcal{R}}$ charges $[u : m_i : x : y] = [4 : 2 : 4 : 6]$ to the quantities of the Seiberg-Witten curves [8]. Since g_2 and g_3 are polynomials in u by construction, by bringing the SW curves to the Weierstraß form and using that $[u] = 4$ we have that the degrees of g_2 and g_3 as polynomials in u must be $\deg(g_2) = 2$ and $\deg(g_3) = 3$. Therefore, P_{N_f} is a sextic polynomial in X .

For generic masses \mathbf{m} , the sextic equation $P_{N_f} = 0$ gives rise to $n = 6$ different solutions as functions of j , while for special choices of \mathbf{m} , such as those giving rise to superconformal (AD) theories, we have $2 \leq n \leq 4$ different j -dependent solutions and $6 - n$ j -independent solutions. Since $j : \mathcal{F} \rightarrow \mathbb{C}$ is an isomorphism, the $n \leq 6$ solutions provide a multi-valued (n -valued) function over \mathcal{F} .

To obtain u as a single-valued function of the effective coupling, we choose a different copy of \mathcal{F} for each of the $n \leq 6$ branches, and appropriately identify the boundaries of these domains. These are related to \mathcal{F} by an element of $\mathrm{SL}(2, \mathbb{Z})$, and their union is

$$\mathcal{F}_{N_f} = \bigcup_{j=1}^n \alpha_j \mathcal{F}, \quad (2.12)$$

with $\alpha_j \in \mathrm{SL}(2, \mathbb{Z})$. A priori, there is no canonical choice for the α_j , they are determined up to the action of the duality group of the theory. However, some choices are more natural than others. If we demand that \mathcal{F}_{N_f} is connected and take $\alpha_1 = \mathbb{1} \in \mathrm{SL}(2, \mathbb{Z})$, there is only a finite number of choices for \mathcal{F}_{N_f} . In some cases, \mathcal{F}_{N_f} is a modular curve $\Gamma \backslash \mathbb{H}$ for a congruence subgroup $\Gamma \subseteq \mathrm{SL}(2, \mathbb{Z})$. In such cases, n equals the index of Γ in $\mathrm{SL}(2, \mathbb{Z})$ [55]. For later use, we define the set of α_j as $\mathcal{C}_{N_f} = \{\alpha_j, j = 1, \dots, n\}$.

For *generic* masses, $n = 6$ and \mathcal{F}_{N_f} has $3 + N_f$ cusps, corresponding to weak coupling $\tau \rightarrow i\infty$ and the $2 + N_f$ singularities of the theory. We find the widths of the cusps by expanding $j(\tau) = \mathcal{J}(u, \mathbf{m}, \Lambda_{N_f})$ for τ near the cusp. For general $N_f \in \{0, 1, 2, 3\}$, the cusp at infinity has width $h_\infty = 4 - N_f$. This is because $q^{-1} \sim j(\tau) = \mathcal{J} \sim u^{4-N_f}$, which implies $u(\tau) \sim q^{-\frac{1}{4-N_f}}$ (where $q = e^{2\pi i \tau}$). Thus for large τ , $u(\tau)$ is invariant under T^{4-N_f} , where $T : \tau \mapsto \tau + 1$. Near any singularity u_s , it is clear that $q^{-1} \sim \frac{1}{(u-u_s)^{h_s}}$, where n_s is the multiplicity of the singularity. Similarly, near u_s one finds $u(\tau) - u_s \sim q^{\frac{1}{h_s}}$. Locally, the function $u(\tau)$ has period h_s , giving the width h_s of the cusp. The widths of all cusps then add up to 6,

$$h_\infty + \sum_s h_s = 6. \quad (2.13)$$

As mentioned above, the equation $P_{N_f} = 0$ gives six different solutions for u . A natural question that then arises is which of these six to use as our u . In some sense this is of course arbitrary, all of them correspond to the order parameter u simply expressed in different duality frames. On the other hand, the most natural solution is the one corresponding to the weak coupling duality frame where $|u|$ is large for $\tau \rightarrow i\infty$. Since the width of the cusp at infinity is $4 - N_f$ we see that there is still some ambiguity in this choice as long as $N_f < 3$, but for $N_f = 3$ there is exactly one choice. It turns out that this has $u \rightarrow -\infty$ for $\tau \rightarrow i\infty$, and it further turns out that this choice can be taken for all $N_f \leq 3$ theories, and is preserved under the decoupling of hypermultiplets. We therefore make this choice throughout. Note that this sign differs from the conventional choice in the literature [8, 56, 57].

Different mass configurations can give different decompositions of 6. When singularities merge, their cusps are identified under the duality group and their widths add up. Moreover a cusp moves from the real axis to infinity upon decoupling of a matter multiplet.

For *special* choices of the masses, not all singularities correspond to cusps $i\infty$ or the real line; also singularities in the interior of the upper half-plane can occur. The theories at these points are of superconformal or Argyres-Douglas type, and the widths of all cusps add up to n .

Yet another aspect of the parametrisation by τ is that for special values of τ in the interior of \mathcal{F} , otherwise distinct solutions can coincide. These are branch points of the solutions, where the function $u(\tau)$ ceases to be meromorphic in τ . The branch points in \mathcal{F}_{N_f} emanate a branch cut. We will discuss these aspects in more detail in Section 2.1.2.

For generic masses the equation $P_{N_f}(X) = 0$ furthermore defines a Riemann surface, which is a 6-fold ramified covering over the classical modular curve $\mathrm{SL}(2, \mathbb{Z}) \backslash \mathbb{H}$ [58]. On this Riemann surface, any root u forms a *meromorphic* map to the Coulomb branch. See also [59].

There is a procedure to find closed expressions for the order parameters in special cases. The sextic equation (2.11) for fixed masses \mathbf{m} and scale Λ can be viewed as a polynomial over the algebraic field $\mathbb{C}(\Gamma)$ of modular functions on $\Gamma = \mathrm{SL}(2, \mathbb{Z})$. Such nontrivial polynomials define field extensions over $\mathbb{C}(\Gamma)$. By the fundamental theorem of Galois theory, there is a one-to-one correspondence between the Galois group of the field extension and its intermediate fields. Intermediate fields can be obtained by adjoining roots of the polynomial to the base field. Since $P_{N_f}(X)$ is a sextic polynomial, for generic masses \mathbf{m} it is not possible to find exact expressions for the roots. However, if one of the intermediate fields is known, the polynomial factors over the intermediate field into products of polynomials of lower degree. If the resulting degree is less than or equal to 4, there are closed formulas for the roots.

We find that in many cases, such as massive $N_f = 2$ and 3 with one mass parameter (see Sec. 2.2 for the case of $N_f = 2$), $\mathbb{C}(\Gamma(2))$ for the principal congruence subgroup $\Gamma(2)$ (see Appendix A) is an intermediate field. Since the function $\lambda = \frac{\vartheta_2^4}{\vartheta_3^4}$ is a Hauptmodul for the genus 0 congruence subgroup $\Gamma(2)$, it is the root of a polynomial of degree $[\Gamma : \Gamma(2)] = 6$ over $\mathbb{C}(\Gamma)$. More precisely, there exists a rational function \mathcal{R} with the property that $\mathcal{R}(\lambda(\tau)) = j(\tau)$. It is given by

$$\mathcal{R}(p) = 2^8 \frac{(1 + (p-1)p)^3}{(p-1)^2 p^2}. \quad (2.14)$$

Instead of solving $\mathcal{J}(u, \mathbf{m}, \Lambda) = j(\tau)$ we can then rather solve $\mathcal{J}(u, \mathbf{m}, \Lambda) = \mathcal{R}(\lambda(\tau))$. If $\mathbb{C}(\Gamma(2))$ is an intermediate field, the sextic equation corresponding to this equation factors over $\mathbb{C}(\Gamma(2))$. In massive $N_f = 2, 3$ we find that it factors into three quadratic polynomials with coefficients depending on λ , which can be easily solved analytically. Such rational relations between the j -invariant and Hauptmoduln exist for any genus 0 congruence subgroup, which are classified [60]. They allow to invert the equation $\mathcal{J}(u, \mathbf{m}, \Lambda) = j(\tau)$ for a large class of mass parameters, as we demonstrate in Sec. 2.2. See also [2, 61–65].

2.1.2 Ramification locus

The covering $\mathcal{F}_{N_f}(\mathbf{m}) \rightarrow \mathcal{B}_{N_f}$ is not 1-to-1 on a discrete subset, namely at points of $\mathcal{F}_{N_f}(\mathbf{m})$ where the discriminant $D(P_{N_f})$ vanishes.¹ In all cases, $N_f = 0, 1, 2, 3$, we find that the discriminant of P_{N_f} factorises as

$$D(P_{N_f}) = j^4 (j - 1728)^3 (D_{N_f}^{\text{AD}})^3 D_{N_f}^{\text{bp}}. \quad (2.15)$$

We discuss each of the three factors:

The \mathbf{m} -independent factor

The factor $j^4 (j - 1728)^3$ is independent of the masses \mathbf{m} and can be understood from (2.11). It is immediate that when $j = 12^3$, every root of P_{N_f} has multiplicity at least 2, and if $j = 0$ every root has multiplicity at least 3. On \mathbb{H} this occurs whenever $\tau \in \text{SL}(2, \mathbb{Z}) \cdot i$ or $\tau \in \text{SL}(2, \mathbb{Z}) \cdot \omega_3$, with $\omega_j = e^{2\pi i/j}$. On the modular curve $\text{SL}(2, \mathbb{Z}) \backslash \mathbb{H}$, these orbits collapse to a point and in fact the covering π is ramified only over $\{i\infty, i, \omega_3\}$, or $j \in \{0, 1728, \infty\}$, respectively. This resembles the *Belyi functions*, which are holomorphic maps from a compact Riemann surface to $\mathbb{P}^1(\mathbb{C})$ ramified over precisely these three points [51, 66]. They can be described combinatorially by so-called *dessins d'enfants*. Such dessins have also appeared in the context of SW theory [67–69].

¹The discriminant of a polynomial $p(X) = X^n + a_{n-1}X^{n-1} + \dots + a_1X + a_0 = \prod_{j=1}^n (X - r_j)$ is defined as $D(p) = \prod_{i < j} (r_i - r_j)^2$, in particular it vanishes if and only if two roots coincide. Since we are interested in finding the zeros of $D(p)$, we are not careful about overall normalisation factors.

For generic masses, the SW family of curves do not satisfy this definition, as there are additional ramification points.

The polynomial $D_{N_f}^{\text{AD}}$

The factor $D_{N_f}^{\text{AD}}$ corresponds to Argyres-Douglas (AD) loci, where two or more singularities coincide [9, 70]. More precisely, the zero locus of $D_{N_f}^{\text{AD}}$ corresponds to the masses for which the Coulomb branch contains AD points. To see this, recall that the AD points correspond to

$$g_2(u, \mathbf{m}, \Lambda) = g_3(u, \mathbf{m}, \Lambda) = 0. \quad (2.16)$$

Since g_2 and g_3 are polynomials in u of degrees 2 and 3, respectively, we can eliminate u from the above equations and characterise $\mathcal{L}_{N_f}^{\text{AD}}$ as the zero locus of a polynomial $D_{N_f}^{\text{AD}}$ in \mathbf{m} ,

$$\mathcal{L}_{N_f}^{\text{AD}} = \{\mathbf{m} \in \mathbb{C}^{N_f} | D_{N_f}^{\text{AD}}(\mathbf{m}) = 0\}. \quad (2.17)$$

These are precisely the polynomials appearing in (2.15). From the SW curves we can easily find that they are given by

$$\begin{aligned} D_0^{\text{AD}} &= 1, \\ D_1^{\text{AD}} &= 27\Lambda_1^3 - 64m^3, \\ D_2^{\text{AD}} &= \Lambda_2^6 - 12m_1m_2\Lambda_2^4 + 3(3m_1^4 + 3m_2^4 - 2m_1^2m_2^2)\Lambda_2^2 - 64m_1^3m_2^3, \\ D_3^{\text{AD}} &= \Lambda_3^9 - 12\widetilde{M}_2\Lambda_3^7 + 168\widetilde{M}_3\Lambda_3^6 - 174\widetilde{M}'_4\Lambda_3^5 + 48\widetilde{M}_4\Lambda_3^5 \\ &\quad + 168\widetilde{M}_2\widetilde{M}_3\Lambda_3^4 - 372\widetilde{M}_3^2\Lambda_3^3 + 24\widetilde{M}'_6\Lambda_3^3 - 64\widetilde{M}_6\Lambda_3^3 \\ &\quad - 24\widetilde{M}_3\widetilde{M}'_4\Lambda_3^2 + 96\widetilde{M}_3\widetilde{M}_4\Lambda_3^2 + 6\widetilde{M}_2\widetilde{M}_3^2\Lambda_3 - 27\widetilde{M}'_8\Lambda_3 + 8\widetilde{M}_3^3, \end{aligned} \quad (2.18)$$

where for $N_f = 3$ we have defined the symmetric combinations

$$\begin{aligned} \widetilde{M}_{2k} &= 2^{6k} \sum_{j=1}^3 m_j^{2k}, & \widetilde{M}_3 &= 2^9 \prod_{j=1}^3 m_j, \\ \widetilde{M}'_4 &= 2^{12} \sum_{i<j} m_i^2 m_j^2, & \widetilde{M}'_6 &= 2^{18} \sum_{i \neq j} m_i^2 m_j^4, & \widetilde{M}'_8 &= 2^{24} \sum_{i<j} m_i^4 m_j^4. \end{aligned} \quad (2.19)$$

The type of singularity that appears for specific masses on these loci are found by studying the order of vanishing of g_2 , g_3 and Δ according to the Kodaira classification,

$$\begin{aligned} II : & \quad \text{ord}(g_2, g_3, \Delta) = (1, 1, 2) \text{ or } (2, 1, 2), \\ III : & \quad \text{ord}(g_2, g_3, \Delta) = (1, 2, 3), \\ IV : & \quad \text{ord}(g_2, g_3, \Delta) = (2, 2, 4). \end{aligned} \quad (2.20)$$

See Appendix A.3 for more details. The zero loci of the AD polynomials can be understood as codimension 1 loci in the space $\mathbb{C}^{N_f} \ni \mathbf{m}$ [70]. For $N_f = 3$ such a locus is shown in Fig. 2.1. Argyres-Douglas loci are studied for a more general class of SW theories in [71].

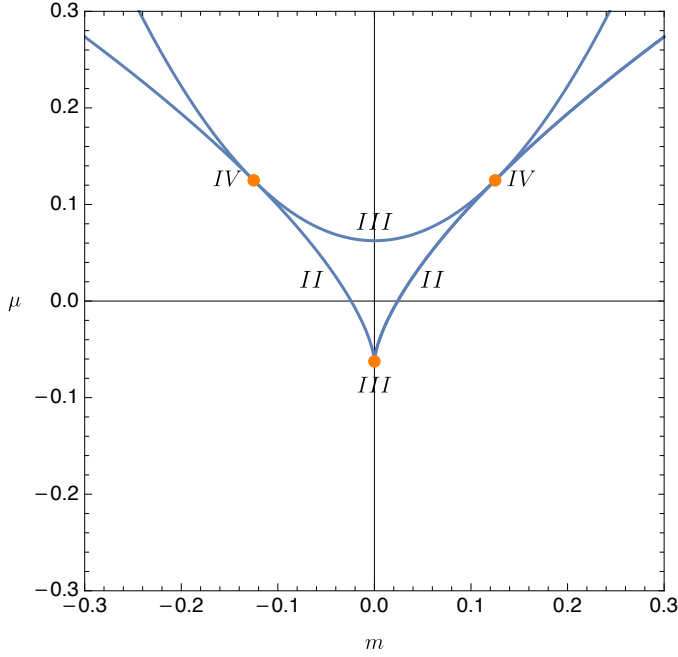

Fig. 2.1 The AD locus $\mathcal{L}_3^{\text{AD}}$ for $N_f = 3$ with masses $\mathbf{m} = (m, m, \mu)$ in the real (m, μ) -plane, with units $\Lambda_3 = 1$. It is a union of three smooth lines, two of them generically describing type *II* AD points and the third one type *III*. The two *II* lines touch at a *III* point, while both *II* lines touch the *III* line in a type *IV* AD point.

In Section 2.1.1, we argued that the widths of the different cusps of the $\text{SU}(2)$ theories always add up to $n \leq 6$. We will now argue that $n < 6$ if and only if \mathbf{m} is a zero \mathbf{m}_{AD} of $D_{N_f}^{\text{AD}}$. It is possible that some zero of Δ is also a zero of g_2 . Then the index is given by the degree of the numerator of j , which can be smaller than 6. In Section 2.2 we study one example of an AD theory appearing in the $N_f = 2$ theory, and demonstrate that the curve degenerates to Kodaira type *III*.² Each singularity type is not exclusive to a specific number of flavours, but appears on the discriminant divisor of the higher N_f theories as well [70]. The three types of AD theories corresponds to 2, 3 or 4 mutually non-local states becoming massless at the AD point. Two states being mutually non-local generally means that they do not commute at spacelike separation such that we can not write down a manifestly local Lagrangian describing their interaction [72]. The charge vectors of mutually non-local states further have non-vanishing Dirac-Schwinger-Zwanziger product [73]. The cusps corresponding to the non-local states are disconnected from the rest of the domain, and the branch points collide at an elliptic point of the duality group. As a result, the index is reduced by $\text{ord } \Delta$, which equals the number of mutually non-local states becoming massless, i.e., 2, 3, and 4 for the theories *II*, *III* and *IV*, respectively. Note that the order of vanishing of the discriminant may be larger than zero for ordinary singularities as well, so it is not enough to simply subtract $\text{ord } \Delta$ from six to get the index right but rather we should

²For AD theories of different type appearing in the theories with other number of flavours we refer to [2].

subtract the number of mutually non-local states becoming massless at each cusp,

$$n = 6 - \# (\text{mutually non-local massless dyons}). \quad (2.21)$$

This is because for the index to reduce it is necessary for g_2 and Δ to have a common root, such that due to (2.6) it is also a root of g_3 and because of (2.16) therefore an AD point. In the limit $\mathbf{m} \rightarrow \mathbf{m}_{\text{AD}}$, the $6 - n$ copies of $\mathcal{F}_{N_f}(\mathbf{m})$ corresponding to the regular singularities are removed from the fundamental domain. There are also mass configurations whose corresponding Coulomb branch contains *two* (type II) AD points. The correspondence (2.21) nevertheless holds, for a similar argument as presented above.

The polynomial $D_{N_f}^{\text{bp}}$

The last factor $D_{N_f}^{\text{bp}}$ corresponds to branch points. These are values of j for which two solutions of $P_{N_f}(X) = 0$ coincide, such that the map $u : \mathcal{F}_{N_f}(\mathbf{m}) \rightarrow \mathcal{B}_{N_f}$ is not 1-to-1 on these points. The identifications are different from the multiple images of \mathcal{F} in \mathcal{B}_{N_f} , which identify the images of the boundary of \mathcal{F} , $\alpha_j(\partial\mathcal{F})$, in $\mathcal{F}_{N_f}(\mathbf{m})$.

The $D_{N_f}^{\text{bp}}$ are explicitly given by

$$\begin{aligned} D_0^{\text{bp}} &= 1, \\ D_1^{\text{bp}} &= 27j\Lambda_1^6 - 27 \cdot 2^{14}m^3\Lambda_1^3 + 2^{20}m^6, \\ D_2^{\text{bp}} &= (m_1^2 - m_2^2)^2 j^2 \Lambda_2^8 - 128\Lambda_2^4 \left(216(m_1^8 + m_2^8) - 288m_1^2 m_2^2 (m_1^4 + m_2^4) \right. \\ &\quad + 16m_1^4 m_2^4 + 240m_1^3 m_2^3 \Lambda_2^2 - 72m_1 m_2 (m_1^4 + m_2^4) \Lambda_2^2 + 9(m_1^4 + m_2^4) \Lambda_2^4 \\ &\quad \left. - 42m_1^2 m_2^2 \Lambda_2^4 - 2m_1 m_2 \Lambda_2^6 \right) j + 2^{12} (16m_1 m_2 - \Lambda_2^2)^3 P_2^{\text{AD}}, \end{aligned} \quad (2.22)$$

and we define $\mathcal{L}_{N_f}^{\text{bp}}$ as the zero locus of $D_{N_f}^{\text{bp}}$. The expression for D_3^{bp} for generic masses is very long so we do not write it out here, but we can note that it has degree three in j .

To show that the zero locus of the polynomials (2.22) really correspond to branch points we will need some specific details of the corresponding theory and we therefore hold off on this discussion until Sec. 2.2. We can, however, note that by solving $D_{N_f}^{\text{bp}} = 0$ for j and plugging it into (2.11) we get the corresponding solutions for u . For example, in $N_f = 1$ we find $u = \frac{4}{3}m^2$ and as is easy to show, away from $m = m_{\text{AD}} = \frac{3}{4}\Lambda_1$, this is not part of the discriminant of the curve and therefore does not correspond to a physical singularity of the theory. We denote a branch point of u in \mathcal{F}_{N_f} by τ_{bp} , and its image in \mathcal{B}_{N_f} as u_{bp} . As explained in Section 2.1.5, for generic masses there are two branch points τ_{bp} and τ'_{bp} with image $u_{\text{bp}} = u(\tau_{\text{bp}}) = u(\tau'_{\text{bp}})$. Since their image in \mathcal{B}_{N_f} is the same, the points τ_{bp} and τ'_{bp} are identified in \mathcal{F}_{N_f} , even though they appear as distinct points in plots of \mathcal{F}_{N_f} in \mathbb{H} . A branch cut emanates from each branch point; there can be a single cut connecting both branch points, or two separate cuts which go to either $i\infty$ or to the real axis.

2.1.3 Partitioning the u -plane

An approach to better understand the u -plane geometry is to study the partitions that the map $u : \mathcal{F}_{N_f} \rightarrow \mathcal{B}_{N_f}$ produces on the u -plane \mathcal{B}_{N_f} . Let us study the union (2.12). Now since $u(\mathcal{F}_{N_f}) = \mathcal{B}_{N_f}$, it is natural to ask what

$$\mathcal{T}_m = u \left(\bigcup_{j=1}^n \alpha_j \partial \mathcal{F} \right) \subseteq \mathcal{B}_{N_f} \quad (2.23)$$

describes. The insight is that while $j : \mathcal{F} \rightarrow \mathbb{C}$ is an isomorphism, it surjects the boundary onto a half-line,

$$j(\partial \mathcal{F}) = (-\infty, 12^3] \subseteq \mathbb{R} \subseteq \mathbb{C}. \quad (2.24)$$

The only other regions in \mathcal{F} where j is real are the $\mathrm{SL}(2, \mathbb{Z})$ images of the half-line $i[1, \infty)$ on the imaginary axis. We can directly apply this to the SW curves, whose j -invariant $\mathcal{J}(u, \mathbf{m}, \Lambda)$ is identified with $j(\tau)$. The partitioning is then

$$\mathcal{T}_m = \{u \in \mathcal{B}_{N_f} \mid \mathcal{J}(u, \mathbf{m}, \Lambda_{N_f}) \in (-\infty, 12^3]\}. \quad (2.25)$$

It is included in the level set $\mathrm{Im} \mathcal{J} = 0$. Let us therefore study the curves

$$\mathrm{Im} \mathcal{J}(u, \mathbf{m}, \Lambda_{N_f}) = 0, \quad (2.26)$$

which contrary to (2.25) are algebraic curves. It turns out that some of the components of this equation do not belong to the partitioning (2.25), and it is clear that they correspond to components of curves with $j > 12^3$. Due to the imaginary part, it is instructive to choose coordinates $u/\Lambda_{N_f}^2 = x + iy$. The equations (2.26) are straightforward to compute in terms of zero-loci of polynomials in x and y . For fixed \mathbf{m} , they define algebraic varieties

$$T_m(x, y) = 0. \quad (2.27)$$

More specifically, they are an N_f -parameter family of affine algebraic plane curves. For the pure $N_f = 0$ theory, one finds

$$T_0 = xy(81 - 288x^2 + 336x^4 - 128x^6 + 288y^2 - 352x^2y^2 - 128x^4y^2 + 336y^4 + 128x^2y^4 + 128y^6). \quad (2.28)$$

The identification of this partitioning of the u -plane for the pure theory is shown in Figure 2.2. The defining equations can be computed in full generality for any N_f , but they are rather lengthy: The polynomials T_m for generic masses have total degree $8 + N_f$. For generic real masses, the polynomials T_m have 30, 131, and 1081 terms in $N_f = 1, 2$ and 3 , respectively. If we allow the masses to be complex, we can decompose $m_i = \mathrm{Re} m_i + i \mathrm{Im} m_i$ and the T_m are then polynomials in $x, y, \mathrm{Re} m_i$ and $\mathrm{Im} m_i$.

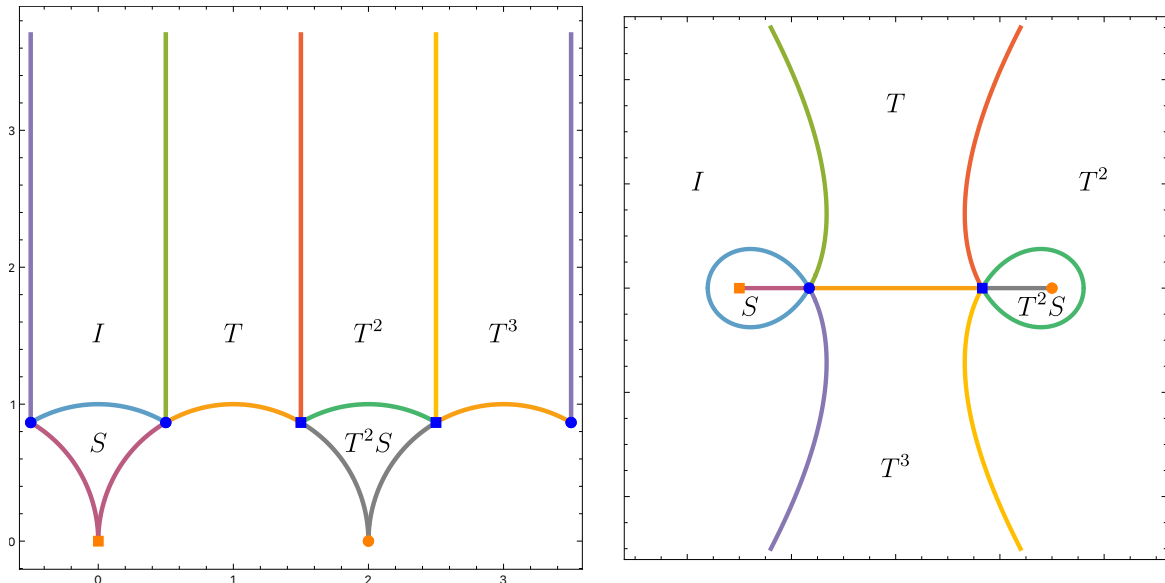

Fig. 2.2 Identification of the components of the partitioning \mathcal{T} in the pure theory. The left figure is the fundamental domain of the τ -plane while the right figure gives the mapping of the boundaries to the u -plane under the map Eq. (1.40). The u -plane \mathcal{B}_0 is partitioned into 6 regions $u(\alpha\mathcal{F})$, with the $\alpha \in \text{SL}(2, \mathbb{Z})$ given in both pictures. These six regions correspond, physically, to different duality frames of the theory. The four regions connected to infinity are however mutually local with respect to each other, and we can thus use the same local parameter in these frames.

For generic (complex) masses in $N_f = 1, 2$ and 3 , T_m has 93, 1310 and 48754 terms, respectively.

The polynomials T_m are in general reducible. For instance, for $\mathbf{m} = (m, m)$ and $\mathbf{m} = (m, 0, 0)$, T_m factors into multiple nontrivial polynomials. It is straightforward to check that T_m for given N_f flows into T_m for $N_f - 1$ by decoupling one hypermultiplet. This allows to study the decoupling procedure of the fundamental domains in detail.

The partitioning \mathcal{T}_m is a finite union of smooth curves that intersect. The tessellation of \mathbb{H} in $\text{SL}(2, \mathbb{Z})$ images of \mathcal{F} ,

$$\mathcal{T}_{\mathbb{H}} = \bigcup_{\alpha \in \text{SL}(2, \mathbb{Z})} \alpha(\partial\mathcal{F}) = \left\{ \tau \in \mathbb{H} \mid j(\tau) \leq 12^3 \right\}, \quad (2.29)$$

has intersection points $\tau \in \text{SL}(2, \mathbb{Z}) \cdot e^{\frac{\pi i}{3}}$, where $j(\tau) = 0$. From (2.8) we see that these intersection points correspond to $\mathcal{J}(u, \mathbf{m}, \Lambda) = 0$, whose only solutions are given by $g_2(u, \mathbf{m}, \Lambda) = 0$ (see (2.7)). Since g_2 is a polynomial in u of degree 2 for all curves (2.1), there are at most two intersection points in \mathcal{T}_m corresponding to $\mathcal{J} = 0$. As g_2 is strictly quadratic, there is also always at least one such point. We find below that when the branch points (as introduced in Section 2.1.2) belongs to \mathcal{T}_m , they give further intersection points of \mathcal{T}_m .

One can study how the partitioning is deformed upon varying the masses. For the cases where the branch points belong to \mathcal{T}_m , the complex u -plane is generically

partitioned into 6 regions. When going to the AD locus two or more of these regions shrink to a point together with at least one branch point. At precisely $m = m_{\text{AD}}$, the u -plane is then partitioned into ≤ 4 regions, giving an explanation for the discontinuous decrease in the index in the limit $m \rightarrow m_{\text{AD}}$. This can also be understood directly from the polynomials $T_m(x, y)$. For instance, at the point $m = m_{\text{AD}} = \frac{3}{4}\Lambda_1$ in $N_f = 1$, the polynomial $T_{m_{\text{AD}}}(x, y)$ contains a factor $9 - 24x + 16x^2 + 16y^2$. Its zero locus in \mathbb{R}^2 is just a point $x + iy = \frac{3}{4} = u_{\text{AD}}/\Lambda_1^2$, while the massive deformation away from m_{AD} describes a curve that encloses a region. For $u_{\text{bp}} \notin \mathcal{T}_m$ one needs to cut and glue interior points of different regions and the u -plane is therefore partitioned into less than 6 regions. See for example Fig. 2.8.

2.1.4 Matone's relation for massive theories

In the pure $\mathcal{N} = 2$ supersymmetric gauge theory, there is a striking expression for the derivative $du/d\tau$ in terms of the discriminant Δ_0 and da/du . The relation reads [74, 75],

$$\frac{du}{d\tau} = -4\pi i \Delta_0 \left(\frac{da}{du} \right)^2. \quad (2.30)$$

Since u is proportional to $\partial F/\partial\Lambda_0$, this equation is equivalent to a recursion relation for the prepotential F [76–78]. Moreover, as Δ_0 and da/du are both topological couplings, this is a useful relation for evaluation of the u -plane integral [40, 43, 45]. Similar relations have also been obtained in the massless $N_f = 1, 2, 3$ theories [57]. We will refer to a relation of the type (2.30) as Matone's relation. In this Section, we derive a generalisation of (2.30) for massive $N_f = 1, 2, 3$.

Periods and Weierstraß form

We proceed by first deriving an expression for da/du . To this end, recall that a is given as a period integral (1.33), and that the derivative of the SW differential λ to u is holomorphic [8]. Therefore, we can express da/du in terms of the variables x and y of (2.5)

$$\frac{da}{du} = \frac{\sqrt{2}}{4\pi} \int_{\gamma} \frac{dx}{y}, \quad (2.31)$$

where γ is one of the cycles of the elliptic curve. To determine this quantity for the theories with $N_f \leq 3$, we map the curve \mathcal{W} to the modular Weierstraß form $\widetilde{\mathcal{W}}$, $A : \mathcal{W} \rightarrow \widetilde{\mathcal{W}}$. See for example [79, Section 7.1]. The curve $\widetilde{\mathcal{W}}$ reads

$$\widetilde{\mathcal{W}} : \quad \tilde{y}^2 = 4\tilde{x}^3 - \tilde{g}_2\tilde{x} - \tilde{g}_3, \quad (2.32)$$

with the variables related by the map A as

$$A : \begin{cases} \tilde{x} = \alpha^2 x = \wp(z), \\ \tilde{y} = \alpha^3 y = \wp'(z), \\ \tilde{g}_2 = \alpha^4 g_2, \\ \tilde{g}_3 = \alpha^6 g_3, \end{cases} \quad (2.33)$$

where \wp is the Weierstraß function and $z \in \mathbb{C}$ a coordinate on the curve. Since $\widetilde{\mathcal{W}}$ is the modular Weierstraß curve, the variables \tilde{g}_2 and \tilde{g}_3 equal

$$\tilde{g}_2 = \frac{4\pi^4}{3} E_4, \quad \tilde{g}_3 = \frac{8\pi^6}{27} E_6, \quad (2.34)$$

with E_k the Eisenstein series defined in (B.7). We note that the variables for \mathcal{W} (2.5) have weight 0 under modular transformations, while in (2.32) the weights are $\text{wt}(\alpha, \tilde{y}, \tilde{x}, \tilde{g}_2, \tilde{g}_3) = (1, 3, 2, 4, 6)$. Using the two equations for \tilde{g}_2 and \tilde{g}_3 , we can solve for u and α . The relation

$$\alpha = \frac{\sqrt{2}\pi}{3} \sqrt{\frac{g_2 E_6}{g_3 E_4}}, \quad (2.35)$$

will be particularly useful for us. This relation can also be derived using Picard-Fuchs equations [80].

Now it is straightforward to determine da/du (2.31) using the Weierstraß representation of (\tilde{x}, \tilde{y}) ,

$$\frac{da}{du} = \frac{\sqrt{2}\alpha}{4\pi} \int_{\tilde{\gamma}} \frac{d\tilde{x}}{\tilde{y}} = \frac{\sqrt{2}\alpha}{4\pi}, \quad (2.36)$$

where $\tilde{\gamma}$ is the image of the γ under the map A , with the variable z of $\tilde{x}(z)$ changing from 0 to 1.

We continue by studying the discriminants of \mathcal{W} and $\widetilde{\mathcal{W}}$. Using $E_4^3 - E_6^2 = 12^3 \eta^{24}$ with η as in (B.5), we find for the discriminant of $\widetilde{\mathcal{W}}$, $\tilde{\Delta} = (2\pi)^{12} \eta^{24}$. The discriminant of \mathcal{W} , Δ_{N_f} (2.6), on the other hand is a polynomial in u , \mathbf{m} and Λ and therefore has weight 0. The two discriminants are related by

$$\tilde{\Delta} = \alpha^{12} (-1)^{N_f} \Lambda_{N_f}^{8-2N_f} \Delta_{N_f}, \quad (2.37)$$

or substituting α in terms of da/du (2.36),

$$\eta^{24} = 2^6 (-1)^{N_f} \Lambda_{N_f}^{2(4-N_f)} \left(\frac{da}{du} \right)^{12} \Delta_{N_f}, \quad (2.38)$$

which holds for $0 \leq N_f \leq 3$. Similar expression exist for $N_f = 4$ and $\mathcal{N} = 2^*$ [39].

Let us consider the case that \mathcal{W} or $\widetilde{\mathcal{W}}$ is singular. The curve $\widetilde{\mathcal{W}}$ is only singular at the cusps $\tau \in \{i\infty\} \cup \mathbb{Q}$, since $\tilde{\Delta} \sim \eta^{24}$ vanishes at the cusps and is non-vanishing for τ in the interior of \mathbb{H} . From (2.37) we see that, at the cusps of $\widetilde{\mathcal{W}}$ either da/du or

Δ_{N_f} must vanish. On the other hand, for τ in the interior of \mathbb{H} , $\tilde{\Delta}$ is non-vanishing. This means that, if \mathcal{W} is singular ($\Delta_{N_f} = 0$) for such values of τ , da/du should diverge. This is exactly what happens at the AD points,

$$\frac{du}{da}(\tau_{\text{AD}}) = 0, \quad \Delta_{N_f}(u(\tau_{\text{AD}})) = 0, \quad \tau_{\text{AD}} \in \mathbb{H}. \quad (2.39)$$

We can further note that $\frac{du}{da}(\tau) = 0$ is true also for singularities that are cusps and not elliptic points, i.e., $\Delta_{N_f} = 0$ for $\tau \in \mathbb{Q}$. This is because if u is not an elliptic point then $g_2 \neq 0$ and $g_3 \neq 0$, since otherwise, from $\Delta = g_2^3 - 27g_3^2$, both would be zero, giving an elliptic point. Then, from (2.36) we have that $\left(\frac{du}{da}\right)^2$ is proportional to $\frac{E_4}{E_6}$. This is a meromorphic modular form of weight -2 for $\text{SL}(2, \mathbb{Z})$, and one can show using modular transformations that it vanishes on \mathbb{Q} . Therefore, we have that $\Delta_{N_f} = 0$ implies $\frac{du}{da} = 0$.

Matone's relation

We will now give a generalisation of (2.30) that holds also for the massive $N_f = 1, 2, 3$ theories. Let us denote by $'$ the derivative with respect to u keeping \mathbf{m} and Λ_{N_f} fixed. The derivative with respect to τ is always given explicitly. From the explicit expression for j as function of τ (B.12), it is easy to check that $\frac{d}{d\tau}j = -2\pi i \frac{E_6}{E_4}j$. Using the chain rule and (2.8), we can express this as $\frac{d}{d\tau}\mathcal{J} = \mathcal{J}'\frac{du}{d\tau}$. This gives the first important identity,

$$\frac{du}{d\tau} = -2\pi i \frac{E_6}{E_4} \frac{\mathcal{J}}{\mathcal{J}'}, \quad (2.40)$$

which holds for any SW curve. From (2.7) we can compute \mathcal{J}' in terms of g'_2 and g'_3 . Using relations (2.35) and (2.36), we can substitute E_6/E_4 in terms of g_2, g_3 and da/du . This gives the exact relation

$$\frac{du}{d\tau} = -72\pi i \frac{g_3}{g_2} \frac{\mathcal{J}}{\mathcal{J}'} \left(\frac{da}{du}\right)^2 = -\frac{8\pi i}{3} \frac{g_2^3 - 27g_3^2}{2g_2g'_3 - 3g'_2g_3} \left(\frac{da}{du}\right)^2. \quad (2.41)$$

An analogous formula for five-dimensional gauge theories was derived from the Picard-Fuchs perspective in [81, Eq. (4.23)]. Both factors on the rhs are only relative invariants, but their product is an absolute invariant of the curve \mathcal{W} . The numerator on the rhs is proportional to the physical discriminant. The equation has modular weight 2, since both $\frac{du}{d\tau}$ and $\left(\frac{da}{du}\right)^2$ are of weight 2.

For $0 \leq N_f \leq 3$,³ we can compute the corresponding g_i , and one can rewrite (2.41) as

$$\frac{du}{d\tau} = -\frac{16\pi i}{4 - N_f} \frac{\Delta_{N_f}}{P_{N_f}^{\text{M}}} \left(\frac{da}{du}\right)^2, \quad (2.42)$$

³We can in fact perform the same computations in the case of $N_f = 4$, leading to a similar formula, but this is omitted here.

where we substituted (2.6) for Δ_{N_f} , and defined the polynomial $P_{N_f}^M$,

$$P_{N_f}^M = \frac{6}{4 - N_f} (-1)^{N_f} \Lambda_{N_f}^{2N_f - 8} (2g_2g_3' - 3g_2'g_3). \quad (2.43)$$

The normalisation is chosen such that $P_{N_f}^M$ is a monic polynomial. Explicit computation gives,

$$\begin{aligned} P_0^M &= 1, \\ P_1^M &= u - \frac{4}{3}m_1^2, \\ P_2^M &= u^2 - \frac{3}{2}(m_1^2 + m_2^2)u + 2m_1^2m_2^2 + \frac{1}{8}m_1m_2\Lambda_2^2 - \frac{1}{64}\Lambda_2^4, \\ P_3^M &= u^3 - 2M_2u^2 + \left(3M_4' + \frac{3}{4}M_3\Lambda_3 - \frac{1}{64}M_2\Lambda_3^2\right)u + \frac{1}{256}M_3\Lambda_3^3 \\ &\quad - \frac{1}{4}M_2M_3\Lambda_3 + \frac{1}{32}(M_4 - M_4')\Lambda_3^2 - 4M_3^2, \end{aligned} \quad (2.44)$$

where we defined

$$\begin{aligned} M_2 &= m_1^2 + m_2^2 + m_3^2, & M_3 &= m_1m_2m_3, \\ M_4 &= m_1^4 + m_2^4 + m_3^4, & M_4' &= \sum_{i < j} m_i^2m_j^2. \end{aligned} \quad (2.45)$$

We note that these polynomials appear in the Picard-Fuchs equations for the periods of these theories and their zeros give regular singular points of the differential equations [25, 26].

The identity (2.42) does in fact not depend on the specific form of the SW curves. Given a Jacobian rational elliptic surface, let $\omega = \int_\gamma \frac{dx}{y}$ be the period of the Néron differential on the elliptic curve. Then $\frac{du}{d\tau} = \frac{1}{3\pi i} \omega^2 \Delta / (2g_2g_3' - 3g_2'g_3)$, with u a coordinate on $\mathbb{P}^1(\mathbb{C})$.

2.1.5 Branch points

An important difference between $N_f = 0$ and $N_f > 0$ are the poles where $P_{N_f}^M$ vanishes. To understand these poles as well as zeros of $du/d\tau$, note that at such points the change of variables between u and τ is ill-defined. We have seen earlier that the change of variables is ill-defined at the points where the discriminant $D(P_{N_f})$ (2.15) vanishes. Indeed if we substitute $\mathcal{J}(u, \mathbf{m}, \Lambda_{N_f})$ for $j(\tau)$ in $D_{N_f}^{\text{bp}}$, $P_{N_f}^M$ factors out.

The reason for this is the following. The discriminant of a polynomial p vanishes if and only if p has a double root. It can be computed as the *resultant* of the polynomial and its formal derivative, $D(p) \sim \text{Res}_X(p, p')$ (see also [82]).⁴ The zero locus $D(P_{N_f}) = 0$ of $P_{N_f}(X)$ is then given by the solutions to the two equations $P_{N_f}(X) = 0$ and $P_{N_f}'(X) = 0$. Since $\Delta_{N_f} \neq 0$, all solutions can be found by solving the former for j and inserting into

⁴The resultant of two polynomials over a commutative ring is a polynomial of their coefficients which vanishes if and only if the polynomials have a common root. It can be computed as the determinant of their Sylvester matrix.

the latter. It is straightforward to show that this gives

$$\frac{g_2^2 g_3}{\Delta_{N_f}} P_{N_f}^M = 0, \quad (2.46)$$

which provides the decomposition (2.15): If $g_2 = 0$ but $g_3 \neq 0$, then $j = 0$. If $g_3 = 0$ but $g_2 \neq 0$, then $j = 12^3$. If both $g_2 = g_3 = 0$, we are in $\mathcal{L}_{N_f}^{\text{AD}} \subseteq \mathcal{L}_{N_f}^{\Delta}$. Now since the sextic equation is only well-defined away from the physical discriminant locus $\mathcal{L}_{N_f}^{\Delta}$ where $\Delta_{N_f} = 0$, the true branch point locus \mathcal{L}^{bp} is the difference of the Matone locus $\mathcal{L}_{N_f}^M = \{u \in \mathcal{B}_{N_f} | P_{N_f}^M = 0\}$ and the discriminant locus,

$$\mathcal{L}_{N_f}^{\text{bp}} = \mathcal{L}_{N_f}^M \setminus \mathcal{L}_{N_f}^{\Delta}. \quad (2.47)$$

On the Coulomb branch with N_f hypermultiplets there are generically $2 + N_f$ distinct singular points. For special mass configurations \mathbf{m} , some singularities can collide. Then Δ_{N_f} has a double root. From above it is clear that this is equivalent to $D(\Delta_{N_f}) = 0$, which in turn is equivalent to $\Delta_{N_f} = 0$ and $\Delta'_{N_f} = 0$. We can again solve the former for g_2 and g_3 and insert into the latter to obtain $P_{N_f}^M \sim \frac{g_2'}{g_3} \Delta_{N_f} = 0$. This implies that whenever Δ_{N_f} has a double root, it is also a root of $P_{N_f}^M$. It is also observed in all examples below. To be more precise, if Δ_{N_f} contains a root of order $d > 1$, then Δ'_{N_f} has the same root but with multiplicity $d - 1$. The excess factors can be extracted by the operation $\text{gcd}(\Delta_{N_f}, \Delta'_{N_f})$, where gcd is the polynomial greatest common divisor. The multiple roots are removed from the discriminant by the square-free factorisation ⁵

$$\widehat{\Delta}_{N_f} = \frac{\Delta_{N_f}}{\text{gcd}(\Delta_{N_f}, \Delta'_{N_f})}. \quad (2.48)$$

This *reduced* discriminant $\widehat{\Delta}_{N_f}$ has single roots only, concretely we map $\prod_s (u - u_s)^{n_s}$ to $\prod_s (u - u_s)$. This quantity is also of importance for determining gravitational couplings to Seiberg-Witten theory [83]. One can show that $\text{gcd}(\Delta_{N_f}, \Delta'_{N_f})$ always divides $P_{N_f}^M$, such that

$$\widehat{P}_{N_f}^M := \frac{\widehat{\Delta}_{N_f}}{\Delta_{N_f}} P_{N_f}^M \quad (2.49)$$

is in fact a polynomial. The branch point equation (2.46) is then equivalent to $\widehat{P}_{N_f}^M / \widehat{\Delta}_{N_f} = 0$, which reduces to

$$\widehat{P}_{N_f}^M = 0. \quad (2.50)$$

The Matone relation thus always takes the form

$$\frac{du}{d\tau} = -\frac{16\pi i}{4 - N_f} \frac{\widehat{\Delta}_{N_f}}{\widehat{P}_{N_f}^M} \left(\frac{da}{du} \right)^2, \quad (2.51)$$

⁵The polynomial gcd is unique only up to multiplication with invertible constants, we choose it such that $\widehat{\Delta}_{N_f}$ is again monic.

where both $\widehat{\Delta}_{N_f}$ and $\widehat{P}_{N_f}^M$ are polynomials. In the subsequent section we show explicitly that the roots of the denominator (2.50) are precisely the branch points. We note that for generic masses the form (2.51) does not differ from (2.42), because $\widehat{\cdot}$ is trivial when all roots are distinct.

As argued above, AD points correspond to points τ_{AD} in the upper half-plane. Since they lie on the discriminant locus, we exclude them to define the sextic polynomial P_{N_f} . We will discuss in more detail below that, if the masses approach the AD locus, a branch point in the u -plane collides with two mutually non-local singularities forming the AD point. The branch point under consideration lifts, while the $N_f - 1$ other branch points remain for a generic point on the AD mass locus $\mathcal{L}_{N_f}^{\text{AD}}$. Thus for a generic point on the AD mass locus, AD points are not branch points of $u(\tau)$. A non-generic example is the most symmetric AD theory, the IV fibre in $N_f = 3$, discussed in more detail in [2, Sec. 6.4]. For this theory, τ_{AD} corresponds to a singular point of the theory as well as a branch point. As a result, the domain for τ does not correspond to that of a congruence subgroup of $\text{SL}(2, \mathbb{Z})$.

Since any branch point τ_{bp} induces a non-trivial monodromy, u does not have a regular Taylor series at such a point. For instance, if the u -plane contains one branch point $u_{\text{bp}} = u(\tau_{\text{bp}})$, then we have $u(\tau) - u_{\text{bp}} = \mathcal{O}(\sqrt{\tau - \tau_{\text{bp}}})$ as $\tau \rightarrow \tau_{\text{bp}}$. If the leading coefficient is nonzero, then $\frac{du}{d\tau}$ diverges at τ_{bp} . Away from the discriminant locus, this can be understood from (2.51): From (2.36) we see that $\frac{da}{du}$ is regular and nonzero at a branch point, since none of g_2 , g_3 , E_4 and E_6 diverge or vanish. Thus the zeros of the denominator $\widehat{P}_{N_f}^M$ correspond to the singular points of $\frac{du}{d\tau}$, as observed.

This can also be seen directly from the \mathcal{J} -invariant of the SW curve. It is easy to show that

$$\mathcal{J}' = 36^3 \frac{g_2^2 g_3}{\Delta_{N_f}^2} P_{N_f}^M, \quad (2.52)$$

which due to (2.46) vanishes at any branch point u_{bp} . Since for fixed mass and scale $\mathcal{J}(u)$ is rational in u , it is a meromorphic function on \mathcal{B}_{N_f} . Away from the discriminant locus it thus has a Taylor series around u_{bp} , where the linear coefficient is missing. We therefore find

$$\mathcal{J}(u) - \mathcal{J}(u_{\text{bp}}) = \mathcal{O}((u - u_{\text{bp}})^{n_{\text{bp}}}), \quad (2.53)$$

with $n_{\text{bp}} \geq 2$. Now we identify $\mathcal{J}(u) = j(\tau)$, which relates the power series of u and τ . For a generic $\tau \in \mathbb{H}$, j has a regular Taylor series at τ with non-zero linear coefficient. However if τ is in the $\text{SL}(2, \mathbb{Z})$ -orbit of i or $e^{\frac{\pi i}{3}}$, j has a zero of order 2 or 3. Let $n_{\tau_{\text{bp}}} \in \{1, 2, 3\}$ be this number for a given branch point $\tau_{\text{bp}} \in \mathbb{H}$. Then $\mathcal{J}(u) - \mathcal{J}(u_{\text{bp}}) = \mathcal{O}((\tau - \tau_{\text{bp}})^{n_{\tau_{\text{bp}}}})$, such that from (2.53) we conclude

$$u(\tau) - u_{\text{bp}} = \mathcal{O}\left((\tau - \tau_{\text{bp}})^{n_{\tau_{\text{bp}}}/n_{\text{bp}}}\right), \quad (2.54)$$

where the leading coefficient is strictly non-zero. From this we see that the branch point τ_{bp} does not necessarily correspond to an n_{bp} -th root, but since the ratio can cancel τ_{bp} rather corresponds to a branch point of order

$$\frac{n_{\text{bp}}}{\text{gcd}(n_{\text{bp}}, n_{\tau_{\text{bp}}})}. \quad (2.55)$$

It is difficult to compute this integer for a generic branch point, however in all examples discussed here and in [2] it is equal to 2, which corresponds to a *square* root.

If the number $\frac{n_{\tau_{\text{bp}}}}{n_{\text{bp}}} \in \mathbb{Q} \setminus \mathbb{Z}$ is larger than 1, then it is clear that $\frac{du}{d\tau}(\tau_{\text{bp}}) = 0$. Conversely, if $\frac{n_{\tau_{\text{bp}}}}{n_{\text{bp}}} < 1$ then $\frac{du}{d\tau}(\tau_{\text{bp}}) = \infty$. We thus see that any branch point has the property that $\frac{du}{d\tau}$ diverges or vanishes, such that the change of variables from the u -plane to the τ -plane is not well-defined.

2.2 The case of two hypermultiplets

As a concrete example of the above analysis let us look at the theory with two fundamental hypermultiplets.⁶ This theory has four strong coupling singularities where massless hypermultiplets appear. For general masses they are distinct points while for special mass configurations one or more singularities can collide. We will begin by restricting to the case of equal masses, $m_1 = m_2 = m$, where we can find explicit expressions for u as a function of τ . Then we briefly discuss the case of two distinct masses before moving on to discuss what happens in the simpler cases of massless hypermultiplets and when fixing the mass to an AD value.

2.2.1 Equal masses

Let us consider first the equal mass case, $\mathbf{m} = (m, m)$, where $m \neq 0$ and $m \neq m_{\text{AD}} = \frac{1}{2}\Lambda_2$. The spectrum and singularity structures are discussed in detail in [84]. In this case, the discriminant becomes

$$\Delta = (u - u_*)^2(u - u_+)(u - u_-), \quad (2.56)$$

where $u_* = m^2 + \frac{\Lambda_2^2}{8}$ and $u_{\pm} = -\frac{\Lambda_2^2}{8} \pm m\Lambda_2$. It is easy to check that $\{u_*, u_+, u_-\}$ never collide other than in the two cases mentioned above. Using the modular lambda function, $\lambda = \frac{\vartheta_2^4}{\vartheta_3^4}$, as a generator of the intermediate field $\Gamma(2)$, the sextic equation factors into three quadratic polynomials over $\Gamma(2)$. These equations can now be solved exactly. In $N_f = 2$, two solutions have the property that $|u(\tau)| \rightarrow \infty$ when $\tau \rightarrow i\infty$.

⁶For the analogous analyses of the theories with one or three hypermultiplets we refer to [2].

As discussed previously, our convention is to pick the one that has $u \rightarrow -\infty$, such that

$$\begin{aligned} \frac{u}{\Lambda_2^2} &= - \frac{\vartheta_4^8 + \vartheta_2^4 \vartheta_3^4 + (\vartheta_2^4 + \vartheta_3^4) \sqrt{16 \frac{m^2}{\Lambda_2^2} \vartheta_2^4 \vartheta_3^4 + \vartheta_4^8}}{8 \vartheta_2^4 \vartheta_3^4} \\ &= - \frac{1}{64} q^{-1/2} - \frac{m^2}{\Lambda_2^2} + \left(64 \frac{m^4}{\Lambda_2^4} - 32 \frac{m^2}{\Lambda_2^2} - \frac{5}{16} \right) q^{1/2} + \mathcal{O}(q). \end{aligned} \quad (2.57)$$

Due to the appearance of the square root in (2.57) u is not holomorphic and there will be branch points in the fundamental domain. From Section 2.1.2 we expect them to be given by

$$j^{\text{bp}}(m) = 16 \frac{(16m^2 - \Lambda_2^2)^3}{m^2}. \quad (2.58)$$

By plugging in the solution for $\mathcal{J}(u, m, \Lambda_2)$ we find that this corresponds to $u = u_{\text{bp}} = 2m^2 - \frac{\Lambda_2^2}{8}$. We recognise this as the root of the polynomial P_2^M of the generalised Matone relation. By using standard relations between the j -invariant and Jacobi theta function we can also check that this coincides with the zeros of the square root.

Defining $f_2(\tau) := 16 \frac{m^2}{\Lambda_2^2} \vartheta_2(\tau)^4 \vartheta_3(\tau)^4 + \vartheta_4(\tau)^8$, we see that the branch point of the square root is $f_2(\tau_0) = 0$. Near τ_0 , the expansion of f_2 reads $f_2(\tau) = (\tau - \tau_0)h(\tau)$, where $h(\tau)$ is holomorphic near τ_0 and $h(\tau_0) \neq 0$. Then one branch of the square root reads $\sqrt{f_2(\tau)} = \sqrt{\tau - \tau_0} \sqrt{h(\tau)}$. Now since $h(\tau_0) \neq 0$, we have that $\tau \mapsto \sqrt{h(\tau)}$ is nonzero and in fact holomorphic in a neighbourhood of τ_0 . However, $\tau \mapsto \sqrt{\tau - \tau_0}$ is strictly non-holomorphic at τ_0 . This proves that u is not holomorphic at τ_0 .

From (2.57) we can also calculate the other interesting quantities,

$$\begin{aligned} \frac{da}{du} &= - \frac{i}{\Lambda_2} \frac{\vartheta_2^2 \vartheta_3^2}{\sqrt{\vartheta_2^4 + \vartheta_3^4 + \sqrt{f_2}}}, \\ \frac{du}{d\tau} &= \pi i \Lambda_2^2 \vartheta_4^8 \frac{2(4 \frac{m^2}{\Lambda_2^2} + 1) \vartheta_2^4 \vartheta_3^4 + \vartheta_4^8 + (\vartheta_2^4 + \vartheta_3^4) \sqrt{f_2}}{8 \vartheta_2^4 \vartheta_3^4 \sqrt{f_2}}. \end{aligned} \quad (2.59)$$

We can explicitly check that they satisfy Matone's relation, (2.42),

$$\frac{du}{d\tau} = - \frac{16\pi i}{2} \frac{\hat{\Delta}}{u - u_{\text{bp}}} \left(\frac{da}{du} \right)^2. \quad (2.60)$$

On the rhs, the double singularity u_* has cancelled, while, as discussed in Section 2.1.4, the branch point $u_{\text{bp}} = 2m^2 - \frac{1}{8}\Lambda_2^2$ remains in the denominator.

Fundamental domain

A fundamental domain can be found in the following way. The six roots of the sextic equation gives the six *cuspidal expansions*. In order to simplify the expressions, let us momentarily set $\Lambda_2 = 1$ and $(a, b, c) := (\vartheta_2^4, \vartheta_3^4, \vartheta_4^4)$. All six expressions can be brought to a canonical form, see Table 2.1.

α_j	$\alpha_j(i\infty)$	$\alpha_j u$
id	$i\infty$	$-\frac{c^2 + ab + (a+b)\sqrt{c^2 + 16m^2 ab}}{8ab}$
T	$i\infty$	$-\frac{b^2 - ac + (-a+c)\sqrt{b^2 - 16m^2 ac}}{-8ac}$
S	0	$-\frac{a^2 + bc + (b+c)\sqrt{a^2 + 16m^2 bc}}{8bc}$
TS	1	$-\frac{b^2 - ac + (a-c)\sqrt{b^2 - 16m^2 ac}}{-8ac}$
TST^{-1}	1	$-\frac{c^2 + ab + (-a-b)\sqrt{c^2 + 16m^2 ab}}{8ab}$
T^2ST	2	$-\frac{a^2 + bc + (-b-c)\sqrt{a^2 + 16m^2 bc}}{8bc}$

Table 2.1 Cusp expansions and associated coset representatives α_j of the solution for $N_f = 2$ with mass $\mathbf{m} = (m, m)$.

The overall sign can be fixed from the purely quadratic term in the numerator. Using the Jacobi identity $a + c = b$, such a representation is unique and the expressions cannot be further simplified. Then instead of studying which transformations give the right values at the cusps, we can take the cusp expansions and try to find maps $\alpha_j \in \text{SL}(2, \mathbb{Z})$ that maps $u(\tau)$ to the functions under study. Due to the square root, this is very subtle. For instance, for T^2ST the Jacobi theta functions transform as $(a, b, c) \mapsto (e^{2\pi i}a, b, c) \mapsto (e^{2\pi i}c, b, a) \mapsto (e^{2\pi i}b, c, e^{\pi i}a)$. We ignore the weight factors since numerator and denominator are homogeneous in the modular weight. This implies that

$$\sqrt{c^2 + 16m^2 ab} \mapsto \sqrt{e^{2\pi i}a^2 + 16m^2 e^{2\pi i}bc} = -\sqrt{a^2 + 16m^2 bc}, \quad (2.61)$$

and gives precisely the last row in Table 2.1. The other transformations can also be proven directly. Such identifications are valid as long as m is generic, and in particular such that the square root does not resolve. This obviously excludes the cases $m = 0$ and $m = \pm m_{\text{AD}}$, and it is conceivable that these are the only cases. We continue by assuming that it is true.

As argued above, there will also be branch points in the fundamental domain due to the square roots appearing in the solution for u . For generic complex mass these points will lie inside the fundamental domain. If we restrict to positive masses we see from (2.58) that $\lim_{m \searrow 0} j^{\text{bp}}(m) = -\infty$, while $j^{\text{bp}}(\frac{\Lambda_2}{4}) = 0$, $j^{\text{bp}}(m_{\text{AD}}) = 12^3 \Lambda_2^4$ with $m_{\text{AD}} = \frac{1}{2} \Lambda_2$ and $\lim_{m \rightarrow \infty} j^{\text{bp}}(m) = +\infty$. Furthermore, one finds that $j^{\text{bp}} : (0, \infty) \rightarrow \mathbb{R}$ is monotonically increasing, and \mathbb{R} is partitioned into $j^{\text{bp}}((0, \frac{\Lambda_2}{4}]) = (-\infty, 0)$, $j^{\text{bp}}([\frac{\Lambda_2}{4}, \frac{\Lambda_2}{2}]) = [0, 12^3 \Lambda_2^4]$ and $j^{\text{bp}}([\frac{\Lambda_2}{2}, \infty)) = [12^3 \Lambda_2^4, \infty)$. We aim to find a curve in τ -space with these properties.

The branch point is located at $u = u_{\text{bp}} = 2m^2 - \frac{\Lambda_2^2}{8}$. In the case $m = 0$, $u_{\text{bp}} = u_+ = u_-$ collide. For $m = \frac{\Lambda_2}{4}$, the branch point $u_{\text{bp}} = 0$ is at the origin. At the AD mass $m = \frac{\Lambda_2}{2}$,

the branch point collides with u_* and u_+ at $\tau_{\text{AD}} = 1 + i$ (see Fig. 2.5). We can use this knowledge to conjecture the branch point paths in τ -space.

The cosets that we found above allow to construct a fundamental domain

$$\mathcal{F}_2(m, m) = \mathcal{F} \cup T\mathcal{F} \cup S\mathcal{F} \cup TS\mathcal{F} \cup TST^{-1}\mathcal{F} \cup T^2ST\mathcal{F}. \quad (2.62)$$

where we take the union of the elements in Table 2.1. This is drawn in Fig. 2.3 together with the conjectured paths of the branch points. Since the α_j generate the whole $\text{SL}(2, \mathbb{Z})$, it is clear that this domain is not a fundamental domain of any congruence subgroup of $\text{SL}(2, \mathbb{Z})$. By computing the q -series of all the cusp expansions, one can match the singularities with the cusps,

$$u(0) = u_-, \quad u(1) = u_*, \quad u(2) = u_+. \quad (2.63)$$

The generic mass case $\mathbf{m} = (m_1, m_2)$ splits the singularity u_* further and removes either $TS\mathcal{F}$ or $TST^{-1}\mathcal{F}$ away from $\tau = 1$.

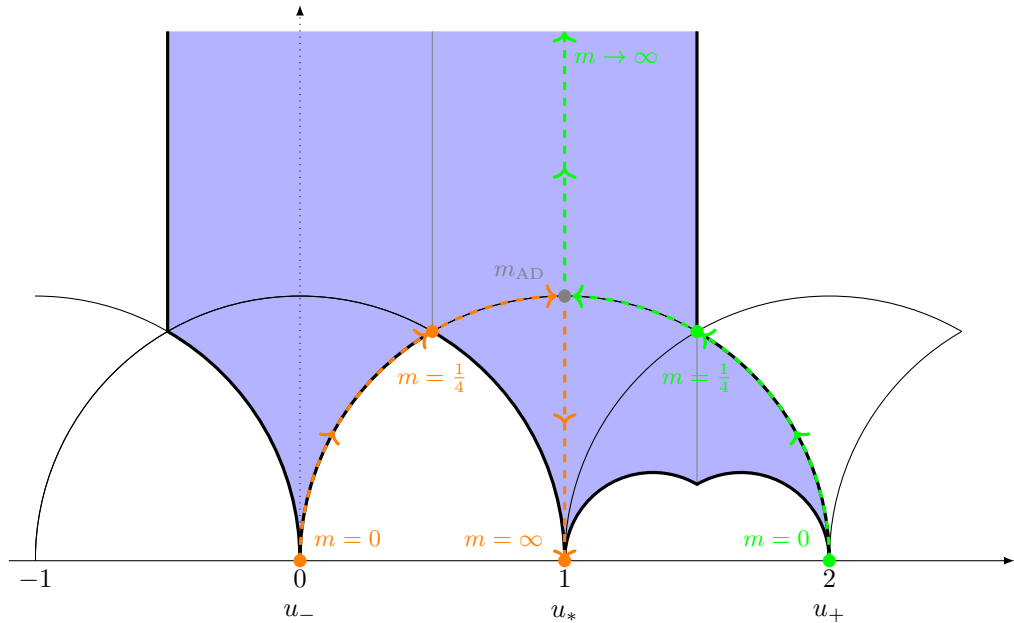

Fig. 2.3 Fundamental domain $\mathcal{F}_2(m, m)$ of massive $\mathbf{m} = (m, m)$ $N_f = 2$ theory. The dashed lines correspond to the conjectured paths of the branch points from zero to infinite mass. For given positive mass m , the two branch points are identified under TST^{-1} , such that there is only one branch point $u_{\text{bp}} = 2m^2 - \frac{\Lambda_2^2}{8}$ on the u -plane. At $m = m_{\text{AD}}$ the two branch points meet, the square root in $u(\tau)$ resolves, and $u(\tau)$ becomes holomorphic and modular.

Let us give some further evidence for the paths of the branch points. The points for $m = 0$, $m = m_{\text{AD}}$ and $m = \infty$ are fixed from the fact that in all three limits the duality group of the theory becomes a congruence subgroup (as is shown below). The branch points approach either $\tau = 1$ or $i\infty$ in the decoupling limit, since these are identified under $\Gamma^0(4)$. This agrees with the fact that $u_{\text{bp}} \rightarrow \infty$ for $m \rightarrow \infty$. We can also check it

against the solution (2.57). The branch point satisfies $f_2 = 0$, for which u simplifies,

$$\frac{u(\tau_{\text{bp}})}{\Lambda_2^2} = -\frac{f_{2\text{B}}(\frac{\tau_{\text{bp}}}{2}) + 16}{128}, \quad f_{2\text{B}}(\tau) = \left(\frac{\eta(\tau)}{\eta(2\tau)}\right)^{24} = 256 \frac{\vartheta_3(\tau)^4 \vartheta_4(\tau)^4}{\vartheta_2(\tau)^8}, \quad (2.64)$$

where $f_{2\text{B}}$ is a Hauptmodul of the congruence subgroup $\Gamma_0(2) \subseteq \text{SL}(2, \mathbb{Z})$. One can plot this u over the curves given in Fig. 2.3, and not only find that it is real everywhere, but it behaves as $u_{\text{bp}} = 2m^2 - \frac{\Lambda_2^2}{8}$ as a function of m . In particular, it is monotonically increasing and has the correct intermediate and limiting points $m \in \{0, \frac{\Lambda_2}{4}, \frac{\Lambda_2}{2}, \infty\}$. Therefore, the curves in Fig. 2.3 are parametrisations of (2.58) compatible with our solution for u .

For any mass, the pair of branch points is identified under u . In order to see this, note that the value of u at a branch point is given by (2.64). Since it is a modular function for $\Gamma^0(2)$, it is invariant under TST^{-1} . This relates the two loci in Fig. 2.3 at both smooth components of each curve,

$$TST^{-1} : \begin{cases} 1 + e^{\varphi i} & \mapsto 1 + e^{(\pi - \varphi) i}, \\ 1 + i\delta & \mapsto 1 + \frac{1}{\delta} i. \end{cases} \quad (2.65)$$

The pair of two such points are the branch points of the square root, and the branch cut can be any path connecting the two branch points [85]. For $m > m_{\text{AD}}$ for instance, one can take it to be the complex interval $\mathcal{I}_\delta = 1 + [\frac{1}{\delta}, \delta] i$. This can also be seen from the fact that when τ traverses a small circle around one branch point, the expression $u(\tau)$ receives a minus sign in front of the square root. According to Table 2.1 this interchanges the cusp expansions in the regions $T\mathcal{F}$ and $TS\mathcal{F}$, and the transition map is precisely $(TS)T^{-1}$ as in (2.65). For $m < m_{\text{AD}}$ the branch points sit on the boundaries of $S\mathcal{F}$ and $T^2ST\mathcal{F}$, and the transition map $S(T^2ST)^{-1} = TST^{-1}$ is identical. In order to achieve single-valuedness, any path encircling one branch point must also encircle the other. On a *dogbone* contour around the interval \mathcal{I}_δ the function $u(\tau)$ returns to the original value, as it picks up twice the phase factor -1 . The function $u(\tau)$ is then a continuous single-valued function on the slit plane $\mathcal{F}(m, m) \setminus \mathcal{I}_\delta$, which one may interpret as a Riemann surface.

Limits to zero, AD and infinite mass

The limits to other theories are given as follows. For $m \rightarrow 0$, the singularities u_+ and u_- merge at $-\frac{\Lambda_2^2}{8}$, which we located at $\tau = 0$. This agrees with the fact that for $m = 0$ the order parameter becomes

$$\begin{aligned} \frac{u(\tau)}{\Lambda_2^2} &= -\frac{1}{8} \frac{\vartheta_3(\tau)^4 + \vartheta_4(\tau)^4}{\vartheta_2(\tau)^4} = -\frac{1}{8} - \frac{1}{64} \left(\frac{\eta(\frac{\tau}{2})}{\eta(2\tau)}\right)^8 \\ &= -\frac{1}{64} (q^{-1/2} + 20q^{1/2} - 62q^{3/2} + 216q^{5/2} + \mathcal{O}(q^{7/2})), \end{aligned} \quad (2.66)$$

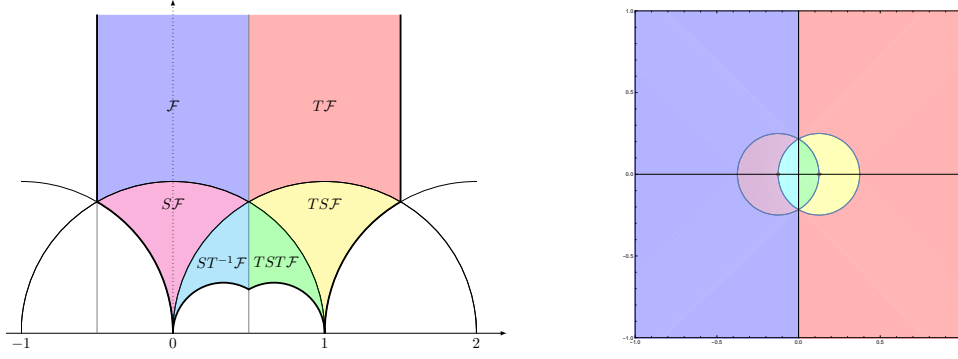

Fig. 2.4 Left: Fundamental domain of $\Gamma(2)$. This is the duality group of massless $N_f = 2$. All three cusps $\{i\infty, 0, 1\}$ have width 2. Right: Plot of the massless $N_f = 2$ u -plane as the union of the images of u under the $\text{ind } \Gamma(2) = 6 \text{ SL}(2, \mathbb{Z})$ images of \mathcal{F} . Here, we use the decomposition $\Gamma(2) \backslash \mathbb{H} = \bigcup_{k, \ell=0}^1 T^\ell S^k \mathcal{F} \cup ST^{-1} \mathcal{F} \cup TST\mathcal{F}$. There is a \mathbb{Z}_2 symmetry which acts by $u \mapsto -u$. The singularities $\tau = 0, 1$ are both touched by two triangles each.

and this is a modular function for $\Gamma(2)$. In particular it is invariant under T^2 . More precisely, we can use $\Gamma(2)$ to move the copies $TST^{-1}\mathcal{F}$ and $T^2ST\mathcal{F}$ in order to obtain a more canonical form of $\Gamma(2) \backslash \text{SL}(2, \mathbb{Z})$. For this, note that we can identify $ST^{-1}\mathcal{F}$ and $T^2ST\mathcal{F}$, since

$$ST^{-1}(T^2ST)^{-1} = \begin{pmatrix} 1 & -2 \\ 2 & -3 \end{pmatrix} \in \Gamma(2) : 2 \mapsto 0. \quad (2.67)$$

Similarly, we can identify $TST^{-1}\mathcal{F}$ with $TST\mathcal{F}$, as the transition function is also in $\Gamma(2)$. This gives precisely Fig. 2.4.

The decoupling limit $m \rightarrow \infty$ to $N_f = 0$ is also interesting. The triangle $TST^{-1}\mathcal{F}$ can be identified with $T^2\mathcal{F}$ since

$$(T^2)^{-1}TST^{-1} = \begin{pmatrix} -1 & 0 \\ 1 & -1 \end{pmatrix} \in \Gamma^0(4) : 1 \mapsto i\infty. \quad (2.68)$$

Similarly, we can identify $TST\mathcal{F}$ with $T^3\mathcal{F}$ as the transition map is in $\Gamma^0(4)$ and also maps $1 \mapsto i\infty$. Lastly, the triangle $T^2ST\mathcal{F}$ around $\tau = 0$ can be identified with $T^2S\mathcal{F}$. This demonstrates that we get the domain $\Gamma^0(4)$ as in Fig. 1.2. The flow to the low energy effective theory with no hypermultiplets can be understood from the modular curve perspective as identifying the cusp $\tau = 1$ of width 2 with the cusp $i\infty$, such that the number of rational cusps decreases by 2, while the width of the cusp $i\infty$ increases by 2.

In the AD limit $m \rightarrow m_{\text{AD}} = \frac{\Lambda_2}{2}$, the mutually non-local singularities u_* and u_+ collide and become a type *III* elliptic point of the curve. This eliminates all the triangles near these cusps: In this case the regions $TST\mathcal{F}$, $TST^{-1}\mathcal{F}$ and $T^2ST\mathcal{F}$ are removed and the domain of the theory with this mass, see Fig. 2.5, remains. This is the domain of the congruence subgroup $\Gamma^0(2)$. The AD point τ_{AD} lies in the interior of \mathbb{H} ,

and is an elliptic point of the duality group $\Gamma^0(2)$. The order parameter now becomes

$$\frac{u(\tau)}{\Lambda_2^2} = -\frac{f_{2B}\left(\frac{\tau}{2}\right) + 40}{64} = -\frac{1}{64} \left(q^{-1/2} + 16 + 276q^{1/2} - 2048q + \mathcal{O}(q^{3/2}) \right), \quad (2.69)$$

where f_{2B} was defined in (2.64), and it is the McKay-Thompson series of class 2B [86, 87, 36]. It is a Hauptmodul for $\Gamma_0(2)$. Therefore, u is a modular function for $\Gamma^0(2)$.

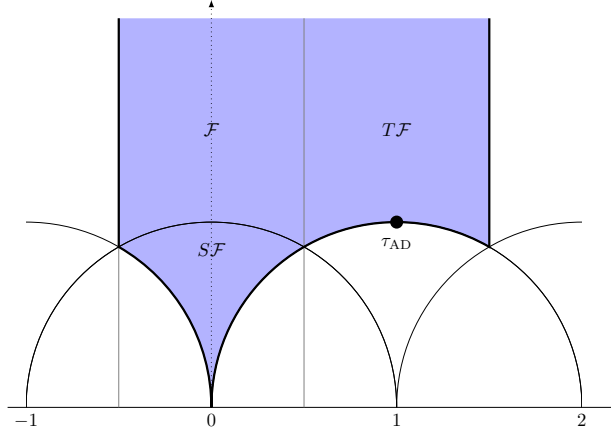

Fig. 2.5 Fundamental domain of $\Gamma^0(2)$. This is the duality group of $N_f = 2$ with masses $\mathbf{m} = \frac{1}{2}(\Lambda_2, \Lambda_2)$. The AD point corresponds to the elliptic fixed point $\tau_{\text{AD}} = 1 + i$.

The mass parameter thus allows us to interpolate between the massless $N_f = 2$ theory through the AD point into the decoupling to the pure theory. A picture of this is shown in Fig. 2.6.

u -plane of AD theory

When tuning the mass to the AD value the disconnected cusps corresponding to the non-local singularities form the fundamental domain for the order parameter of the AD curve, i.e., the curve found from taking the scaling limit to the AD theory [70]. See Fig. 2.6. The disconnected cusps form a fundamental domain for $\Gamma_0(2)$, which is incidentally congruent to the duality group of the asymptotically free theory at the AD point, as discussed above. To demonstrate this, recall that the AD curve reads [70],

$$y^2 = x^3 - \frac{\Lambda_2^2}{4} \tilde{u}x - \frac{\Lambda_2^3}{12} m\tilde{u} + \frac{\Lambda_2^3}{27} m^3. \quad (2.70)$$

This gives for the order parameter

$$\tilde{u}(\tau) = \frac{4}{3}m^2 - \frac{m^2 f_{2B}(\tau)}{64 + f_{2B}(\tau)}, \quad (2.71)$$

with $f_{2B}(\tau)$ as in (2.64). As mentioned before, f_{2B} is a Hauptmodul for $\Gamma_0(2)$, such that the disconnected domain is indeed a fundamental domain for \tilde{u} .

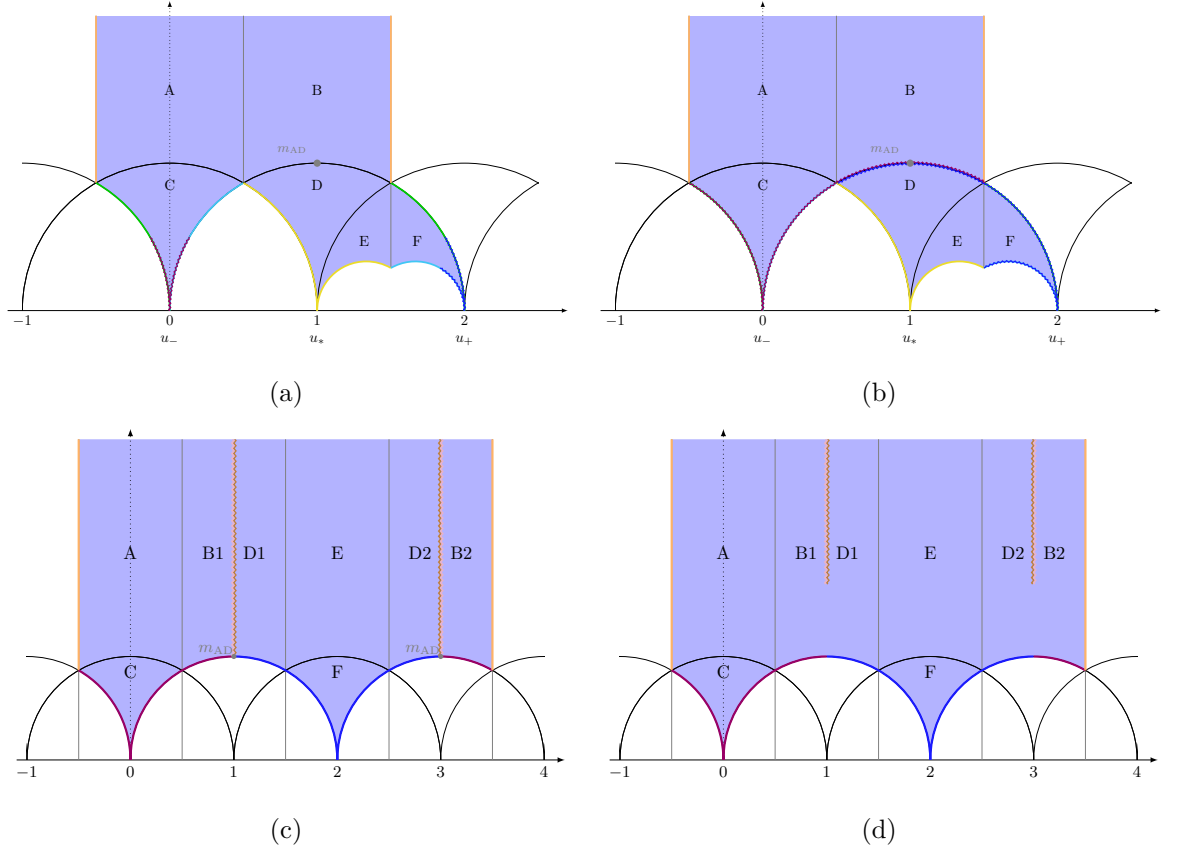

Fig. 2.6 Choice of branch cuts for varying mass parameter in the equal mass $N_f = 2$ theory. Same colour boundaries are, as usual, identified. Starting with a small mass in Figure (a) we introduce two cuts (zig-zag lines) along the paths shown in Fig. 2.3. At the AD mass we can use the identifications of the different boundaries to reorganise the domain in Figure (b) to the one of Figure (c). When we increase the mass further the cuts of Figure (c) move upwards as in Figure (d) eventually reaching infinity and disappearing, leaving us with the domain of the pure theory, Fig. 1.2.

2.2.2 Partitioning of the u -plane

Finally, we can study the partitioning that the domain (2.62) induces on the u -plane under the map (2.57). As studied in Section 2.1.3, the partitioning is contained in a real algebraic plane curve, which is given by the equation $\text{Im } \mathcal{J}(u, \mathbf{m}, \Lambda_2) = 0$. For

generic $\mu = \frac{m}{\Lambda_2}$, we can compute it as the zero locus of the polynomial

$$\begin{aligned}
T_{(m,m)} = & y \left(-128\mu^2 x + 48\mu^2 + 64x^2 - 16x + 64y^2 - 3 \right) \\
& \times \left(-720896\mu^4 x^2 y^2 + 262144\mu^2 x^2 y^4 - 262144\mu^2 x^4 y^2 - 262144\mu^2 x^3 y^2 \right. \\
& - 303104\mu^2 x^2 y^2 - 589824\mu^6 x^2 + 688128\mu^4 x^4 + 737280\mu^4 x^3 + 27648\mu^4 x^2 \\
& - 262144\mu^2 x^6 - 786432\mu^2 x^5 - 86016\mu^2 x^4 - 36864\mu^2 x^3 - 1728\mu^2 x^2 \\
& - 49152\mu^4 x y^2 + 524288\mu^2 x y^4 + 24576\mu^2 x y^2 - 221184\mu^6 x + 20736\mu^4 x \\
& + 589824\mu^6 y^2 + 688128\mu^4 y^4 + 9216\mu^4 y^2 + 262144\mu^2 y^6 + 12288\mu^2 y^4 \\
& - 2880\mu^2 y^2 + 165888\mu^8 - 1944\mu^4 + 81\mu^2 + 786432x^3 y^4 + 65536x^2 y^4 \\
& + 786432x^5 y^2 + 131072x^4 y^2 + 40960x^3 y^2 + 10240x^2 y^2 + 262144x^7 \\
& + 65536x^6 + 12288x^5 + 6144x^4 - 576x^3 + 144x^2 + 262144xy^6 + 28672xy^4 \\
& \left. - 1344xy^2 - 27x \right). \tag{2.72}
\end{aligned}$$

The second factor on the rhs gives a circle on the $x + iy = \frac{u}{\Lambda_2^2}$ -plane with radius $|\mu^2 - \frac{1}{4}|$ and centre $(x, y) = (\mu^2 + \frac{1}{8}, 0)$. By tuning the mass μ from 0 to ∞ , one passes through the AD point $\mu = \frac{1}{2}$ where the radius of the circle shrinks to 0. For this mass, three regions defined through $T_{(m,m)} = 0$ collapse to a point $x + iy = \frac{u_{\text{AD}}}{\Lambda_2^2} = \frac{3}{8}$, which is the only root over \mathbb{R}^2 of the quadratic polynomial. This gives further evidence that the domain (2.62) is in fact correct for all $\mu \in (0, \infty) \setminus \{\frac{1}{2}\}$.

We can find the truncations of the zero locus of (2.72) that gives the partitioning (2.25) in the following way. The locus $y = 0$ cannot be contained fully in \mathcal{T}_m , since otherwise the partition of \mathcal{B}_2 would be into more than 6 parts. By direct computation one can show that for $0 < \frac{m}{\Lambda_2} < \frac{1}{4}$ we have $\mathcal{J}(u, \mathbf{m}) \leq 12^3$ for $u_- < u < u_+$ (recall that $\mathcal{J}(u, \mathbf{m})$ diverges for all u approaching a singularity). This proves that the line from u_- to u_+ is contained in \mathcal{T}_m . It allows to identify the boundary pieces $\alpha_j \partial \mathcal{F}$ on \mathbb{H} with the boundary pieces $\partial(u(\alpha_j \mathcal{F}))$ on \mathcal{B}_2 , which is depicted in Fig. 2.7.

2.2.3 Two distinct masses

In the generic case, the two masses are distinct. We can expand and invert the \mathcal{J} -invariant for large u to find the series (here $\mu_i = \frac{m_i}{\Lambda_2}$)

$$\begin{aligned}
\frac{u(\tau)}{\Lambda_2^2} = & -\frac{1}{64}q^{-\frac{1}{2}} - \frac{1}{2}(\mu_1^2 + \mu_2^2) + \left(24(\mu_1^4 + \mu_2^4) + 16\mu_1^2\mu_2^2 - 32\mu_1\mu_2 - \frac{5}{16} \right) q^{\frac{1}{2}} \\
& - 128 \left(\mu_1^2 + \mu_2^2 \right) \left(16(\mu_1^4 + \mu_2^4) - 14\mu_1\mu_2 + 1 \right) q + \mathcal{O}(q^{\frac{3}{2}}). \tag{2.73}
\end{aligned}$$

The double singularity u_* in the equal mass case now splits into two distinct singularities, u_*^\pm . Due to the locus of masses giving rise to u -planes with AD points, it is difficult to give a fundamental domain $\mathcal{F}_2(\mathbf{m})$ for any choice of $\mathbf{m} = (m_1, m_2)$. From (2.22) it is clear that there are two distinct branch points in \mathcal{B}_2 . When both m_1 and m_2 are real and small, i.e. have not made a phase transition compared to $\mathbf{m} = 0$, one branch point $u_{\text{bp},1}$ belongs to \mathcal{T}_m , while the other $u_{\text{bp},2}$ does not. However, $\mathcal{J}(u_{\text{bp},2}) = j(\tau_{\text{bp},2}) \in \mathbb{R}$ is also real but larger than 12^3 . A natural choice of branch cuts is along the tessellation

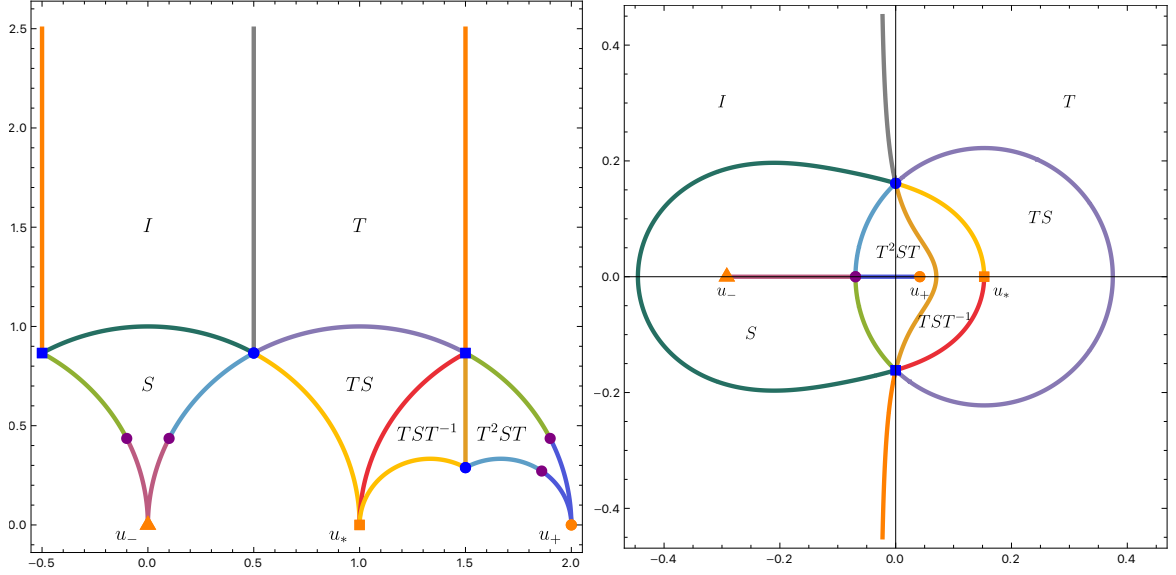

Fig. 2.7 Identification of the components of the partitioning $\mathcal{T}_{(m,m)}$ in $N_f = 2$ for the particular choice $m = \frac{\Lambda_2}{6}$. The left figure is the fundamental domain in the τ -plane while the right figure gives the corresponding partitioning of the u -plane. The mapping between the two is given by Eq. (2.57). The u -plane \mathcal{B}_2 is partitioned into 6 regions $u(\alpha\mathcal{F})$, with the $\alpha \in \text{SL}(2, \mathbb{Z})$ given in both pictures. These correspond, physically, to different duality frames of the theory. However, we note that, obviously, some frames are mutually local with respect to each other, meaning that we can use the same local parameters for these frames. The branch point (purple) identifies four points on $\partial\mathcal{F}(m, m)$. A natural choice of branch cut is on the circle around $\tau = 1$ with radius 1, as suggestive in Fig. 2.3 (we omit it in this Figure for readability). The singularities u_{\pm} correspond to a single massless particle each and thus lie in the interior of a $u(\alpha\mathcal{F})$. The singularity u_* is double and thus lies on the boundary of two such regions. The boundary pieces of $\mathcal{F}(m, m)$ are pairwise identified, which can be found by comparing $\mathcal{F}(m, m)$ with the curve $T_{(m,m)} = 0$. Glueing the corresponding boundary pieces results in a Riemann surface of genus 0 with punctures.

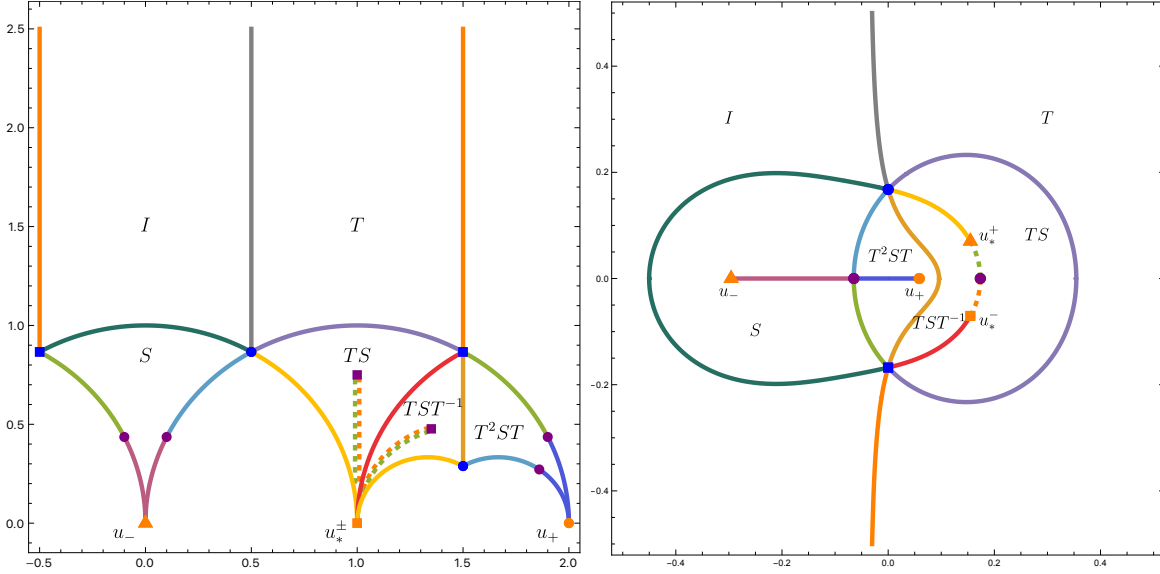

Fig. 2.8 Identification of the components of the partitioning $\mathcal{T}_{(m_1, m_2)}$ in $N_f = 2$ for the particular choice $\mu_1 = \frac{1}{10}$ and $\mu_2 = \frac{1}{4}$. The u -plane \mathcal{B}_2 is naively partitioned into six regions $u(\alpha\mathcal{F})$, with the $\alpha \in \text{SL}(2, \mathbb{Z})$ given in both pictures. Two regions $u(TS\mathcal{F})$ and $u(TST^{-1}\mathcal{F})$ are however glued along the pairs of branch cuts (dotted), running from the two singular points u_*^{\pm} (orange, square) to the branch point $\tau_{\text{bp},2}$ (purple, square). They do not belong to the partitioning \mathcal{T}_m . A natural choice for the branch cut is along the lines where $j(\tau)$ is real.

$\{\tau \in \mathbb{H} \mid j(\tau) \in \mathbb{R}\}$, which aside from (2.29) contains the $\text{SL}(2, \mathbb{Z})$ images of the positive imaginary axis. The plot of the partitioning \mathcal{T}_m shows a new feature compared to the previous case: The u -plane is partitioned into only 5 regions, which is due to two regions $u(\alpha_j\mathcal{F})$ being glued along pairs of branch cuts (see Fig. 2.8). The splitting of u_* into two distinct singularities in this case does not require the two regions $TS\mathcal{F}$ and $TST^{-1}\mathcal{F}$ to taper to distinct cusps, as we have that both $TS, TST^{-1} : i\infty \mapsto 1$. The two singularities are rather split due to the branch cut, and the limit of $u(\tau)$ as $\tau \rightarrow 1$ depends on the path from which $\tau = 1$ is approached. This is different from $u_+ \neq u_-$, where the boundary pieces near the cusps are not identified.

This concludes our analysis of the $\text{SU}(2)$ theory with two fundamental hypermultiplets. A similar analysis can be made for the cases of $N_f = 1$ and $N_f = 3$, see [2]. For $N_f = 3$ with mass vector $\mathbf{m} = (m, 0, 0)$ a closed expression for the order parameter can be found, similar to the equal mass $N_f = 2$ discussed above. The theory with one flavour is more elusive, closed expressions seems to only be available when $m = 0$ or $m = m_{\text{AD}}$. In the massless case there are again branch points due to square roots. This is in contrast to the massless limits of $N_f = 2$ and 3, where the order parameter is fully modular, being a Hauptmodul for $\Gamma(2)$ and $\Gamma_0(4)$, respectively. When discussing the $\text{SU}(3)$ theory in the next Chapter we will find the same function, as the order parameter of the massless $N_f = 1$, appearing as the order parameter on a certain slice of the moduli space. Before that, we will discuss the theory with four flavours.

2.3 The special case of four flavours

Let us now analyse the special case of having four fundamental hypermultiplets in the SU(2) SW theory. As mentioned in Sec. 1.1.1, see Eq. (1.14), we will now have a nontrivial dependence on an extra dimensionless parameter τ_{UV} . To shorten the notation, we will set $\tau_0 := \tau_{\text{UV}}$ and $q_0 := e^{2\pi i \tau_0}$ in the following. Furthermore, the massless theory is now superconformal.

The low-energy physics is again encoded in an elliptic curve which depends holomorphically on the Coulomb branch parameter $u \in \mathcal{B}_4$. To write down the curve, we first define the symmetric mass combinations

$$\begin{aligned} \llbracket m_1^k \rrbracket &= \sum_{i=1}^4 m_i^k, & \llbracket m_1^2 m_2^2 \rrbracket &= \sum_{i<j} m_i^2 m_j^2 \\ \llbracket m_1^4 m_2^2 \rrbracket &= \sum_{i \neq j} m_i^4 m_j^2, & \llbracket m_1^2 m_2^2 m_3^2 \rrbracket &= \sum_{i<j<k} m_i^2 m_j^2 m_k^2, \\ \text{Pf}(\mathbf{m}) &= m_1 m_2 m_3 m_4. \end{aligned} \quad (2.74)$$

The $N_f = 4$ curve for generic masses is then [8]

$$y^2 = W_1 W_2 W_3 + A (W_1 T_1 (e_2 - e_3) + W_2 T_2 (e_3 - e_1) + W_3 T_3 (e_1 - e_2)) - A^2 N, \quad (2.75)$$

where

$$\begin{aligned} W_i &= x - e_i u - e_i^2 R, \\ A &= (e_1 - e_2)(e_2 - e_3)(e_3 - e_1), \\ R &= \frac{1}{2} \llbracket m_1^2 \rrbracket, \\ T_1 &= \frac{1}{12} \llbracket m_1^2 m_2^2 \rrbracket - \frac{1}{24} \llbracket m_1^4 \rrbracket, \\ T_{2,3} &= \mp \frac{1}{2} \text{Pf}(\mathbf{m}) - \frac{1}{24} \llbracket m_1^2 m_2^2 \rrbracket + \frac{1}{48} \llbracket m_1^4 \rrbracket, \\ N &= \frac{3}{16} \llbracket m_1^2 m_2^2 m_3^2 \rrbracket - \frac{1}{96} \llbracket m_1^4 m_2^2 \rrbracket + \frac{1}{96} \llbracket m_1^6 \rrbracket, \end{aligned} \quad (2.76)$$

and the half periods

$$e_1 = \frac{1}{3}(\vartheta_3^4 + \vartheta_4^4), \quad e_2 = -\frac{1}{3}(\vartheta_2^4 + \vartheta_3^4), \quad e_3 = \frac{1}{3}(\vartheta_2^4 - \vartheta_4^4) \quad (2.77)$$

are functions of $\tau_0 := \tau_{\text{UV}}$, with $e_1 + e_2 + e_3 = 0$. We obtain the low energy theory with $N_f = 3$ flavours by taking the limit $\tau_0 \rightarrow i\infty$ (or, equivalently, $q_0 \rightarrow 0$) and $m_4 \rightarrow \infty$ while holding $\Lambda_3 = 64q_0^{\frac{1}{2}} m_4$ fixed. The order parameters are then related as [8]

$$u_{N_f=4} + \frac{1}{4} e_1 \llbracket m_1^2 \rrbracket \rightarrow u_{N_f=3}. \quad (2.78)$$

Let us study the singularity structure of the Coulomb branch. For generic masses $\mathbf{m} = (m_1, m_2, m_3, m_4)$, there are six distinct strong coupling singularities. By tuning the mass, some of those singularities can collide. If we weight each singularity by the number of massless hypermultiplets at that point, the total weighted number of singularities on the u -plane is always 6. Denote by k_l the weight of the l -th singularity, and by $\mathbf{k}(\mathbf{m}) = (k_1, k_2, \dots)$ the vector of those weights. In Table 2.2, we list a selection of specifically symmetric mass configurations. One notices that certain a priori unrelated cases have the same weight vector \mathbf{k} and global symmetries, such as the cases {B, C, D} and {E, F, G}. This will be explained below. It is also clear that $\mathbf{k}(\mathbf{m})$ gives a partition of 6, the total number of singularities on \mathcal{B}_4 .

Name	\mathbf{m}	$\mathbf{k}(\mathbf{m})$	global symmetry
A	$(m, m, 0, 0)$	$(2, 2, 2)$	$SU(2) \times SU(2) \times SU(2) \times U(1)$
B	(m, m, m, m)	$(4, 1, 1)$	$SU(4) \times U(1)$
C	$(2m, 0, 0, 0)$	$(4, 1, 1)$	$SU(4) \times U(1)$
D	$(m, m, m, -m)$	$(4, 1, 1)$	$SU(4) \times U(1)$
E	(m, m, μ, μ)	$(2, 2, 1, 1)$	$SU(2) \times SU(2) \times U(1) \times U(1)$
F	$(m + \mu, m - \mu, 0, 0)$	$(2, 2, 1, 1)$	$SU(2) \times SU(2) \times U(1) \times U(1)$
G	$(m, m, \mu, -\mu)$	$(2, 2, 1, 1)$	$SU(2) \times SU(2) \times U(1) \times U(1)$

Table 2.2 List of some mass cases with enhanced flavour symmetry in $N_f = 4$, with $\mu \neq m$. The vector $\mathbf{k}(\mathbf{m})$ lists the multiplicities of all singularities on the Coulomb branch \mathcal{B}_4 with mass \mathbf{m} .

2.3.1 Triality

Let us study the symmetries of the $N_f = 4$ curve (2.75) with mass $\mathbf{m} = (m_1, m_2, m_3, m_4)$. Scale invariance, the $U(1)_R$ R-symmetry and the $SL(2, \mathbb{Z})$ symmetry acting on τ_0 are explicitly broken by the masses. There is a remnant scale invariance on the Coulomb branch, which manifests itself in the \mathcal{J} -invariant $\mathcal{B}_4 \times \mathbb{C}^4 \times \mathbb{H} \rightarrow \mathbb{C}$ of the curve being a quasi-homogeneous rational function of degree 0 and type $(2, 1, 0)$,

$$\mathcal{J}(s^2 u, s \mathbf{m}, \tau_0) = \mathcal{J}(u, \mathbf{m}, \tau_0), \quad s \in \mathbb{C}^*. \quad (2.79)$$

The $N_f = 4$ theory has an $SO(8)$ flavour symmetry, which becomes the universal double cover $Spin(8)$ in the quantum theory. In particular, there exists a short exact sequence

$$1 \rightarrow \mathbb{Z}_2 \rightarrow Spin(8) \rightarrow SO(8) \rightarrow 1 \quad (2.80)$$

of Lie groups. The cover $Spin(8)$ has an order 6 group $Out(Spin(8))$ of outer automorphisms, which is isomorphic to S_3 [88, 89].⁷

⁷For any Lie group G , there are three associated groups. $Aut(G)$ is the Lie group consisting of all automorphisms of G (i.e. group isomorphisms $G \rightarrow G$), $Inn(G)$ is a normal subgroup of

This group of outer automorphisms acts on the $N_f = 4$ theory as follows. The states with $(n_m, n_e) = (0, 1)$ are the elementary hypermultiplets, which transform in the fundamental vector representation of $\text{Spin}(8)$. The magnetic monopole $(1, 0)$ transforms as one spinor representation, and the dyon $(1, 1)$ transforms as the conjugate spinor representation [8]. By an accidental isomorphism, these three representations are all 8-dimensional and irreducible, and they are permuted by the outer automorphism group $\text{Out}(\text{Spin}(8)) \cong S_3$. It is generated by

$$\mathcal{T} = \begin{pmatrix} 1 & 0 & 0 & 0 \\ 0 & 1 & 0 & 0 \\ 0 & 0 & 1 & 0 \\ 0 & 0 & 0 & -1 \end{pmatrix}, \quad \mathcal{S} = \frac{1}{2} \begin{pmatrix} 1 & 1 & 1 & 1 \\ 1 & 1 & -1 & -1 \\ 1 & -1 & 1 & -1 \\ 1 & -1 & -1 & 1 \end{pmatrix}, \quad (2.81)$$

which act on the column vector $\mathbf{m} \in \mathcal{M} := \mathbb{C}^4$ from the left [8, 90, 91]. The map \mathcal{T} exchanges the two spinors keeping the vector fixed, while \mathcal{S} exchanges the vector with the spinor, keeping the conjugate spinor fixed. This is depicted in Fig. 2.9.

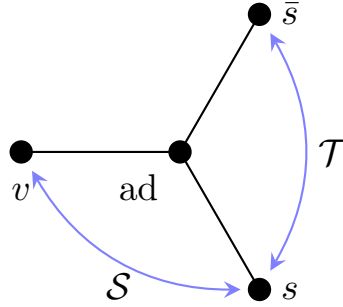

Fig. 2.9 Dynkin diagram of $\mathfrak{d}_4 = \text{Lie}(\text{Spin}(8))$. The group $\mathcal{T} \cong S_3$ of outer isomorphisms acts by permutations on the three conjugacy classes of irreducible representations v , s and \bar{s} attached to the nodes of the diagram. The 28-dimensional adjoint representation is left invariant by \mathcal{T} .

The generators (2.81) satisfy the algebra

$$\mathcal{T}^2 = \mathcal{S}^2 = (\mathcal{S}\mathcal{T})^3 = \mathcal{S}\mathcal{T}^2\mathcal{S} = \mathbb{1}, \quad (2.82)$$

which is a presentation of the symmetric group S_3 . Since $\mathcal{T}^\top\mathcal{T} = \mathcal{S}^\top\mathcal{S} = \mathbb{1}$ but $\det \mathcal{T} = \det \mathcal{S} = -1$, the matrices \mathcal{T} and \mathcal{S} generate a subgroup

$$\mathcal{T} = \langle \mathcal{T}, \mathcal{S} \rangle \quad (2.83)$$

$\text{Aut}(G)$ consisting of inner automorphisms given by $\alpha_g(h) := ghg^{-1}$ for any $g \in G$, and $\text{Out}(G) = \text{Aut}(G)/\text{Inn}(G)$ is the quotient group. The automorphism group of $\text{Spin}(8)$ is $\text{Aut}(\text{SO}(8)) = \text{PSO}(8) \rtimes S_3$ [88].

of the orthogonal group $O(4, \mathbb{C})$, isomorphic to S_3 .⁸ As a consequence, they leave the inner product $[[m_1^2]]$ (2.74) invariant.

The flavour symmetry mixes with the $SL(2, \mathbb{Z})$ -symmetry acting on the UV-coupling τ_0 in an interesting way. To see this, notice that the reduction $\mathbb{Z} \rightarrow \mathbb{Z}_2$ modulo 2 induces a homomorphism $SL(2, \mathbb{Z}) \rightarrow SL(2, \mathbb{Z}/2\mathbb{Z})$. Since $SL(2, \mathbb{Z}/2\mathbb{Z}) \cong S_3$ are isomorphic, by transitivity we have a group homomorphism

$$\varphi : SL(2, \mathbb{Z}) \longrightarrow \text{Out}(\text{Spin}(8)). \quad (2.84)$$

The full symmetry group of the $N_f = 4$ theory is the semidirect product [8]⁹

$$\mathfrak{T} := \text{Spin}(8) \rtimes_{\varphi} SL(2, \mathbb{Z}). \quad (2.85)$$

The group (\mathfrak{T}, \bullet) consists of elements $(A, \gamma) \in \text{Spin}(8) \times SL(2, \mathbb{Z})$, with group operation

$$(A, \gamma) \bullet (\tilde{A}, \tilde{\gamma}) := (A \varphi(\gamma)(\tilde{A}), \gamma \circ \tilde{\gamma}). \quad (2.86)$$

The action of (2.81) is thus accompanied with an action of $SL(2, \mathbb{Z})$ on τ and τ_0 . From (2.82) we find that \mathcal{T}^2 and $\mathcal{S}\mathcal{T}^2\mathcal{S}$ leave any mass configuration invariant. This implies that the theory should also be invariant under the simultaneous action of T^2 and ST^2S on the two couplings. These two matrices in $SL(2, \mathbb{Z})$ generate the principal congruence subgroup $\Gamma(2)$, Fig. 2.4. From this it is also clear that

$$SL(2, \mathbb{Z})/\Gamma(2) = \{I, T, S, TS, ST, TST\} \cong S_3, \quad (2.87)$$

which is another way to see that the group of outer isomorphisms is S_3 [91]. This action is depicted in Fig. 2.10. The subgroup $\Gamma(2)$ is the kernel of the group homomorphism $SL(2, \mathbb{Z}) \rightarrow SL(2, \mathbb{Z}/2\mathbb{Z})$, such that it is in fact a normal subgroup $\Gamma(2) \triangleleft SL(2, \mathbb{Z})$.

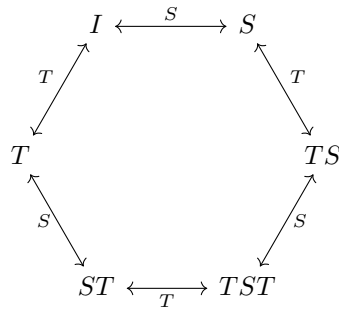

Fig. 2.10 Action of $SL(2, \mathbb{Z})$ on $SL(2, \mathbb{Z})/\Gamma(2) \cong S_3$

⁸They actually form a subgroup of $O(4, \mathbb{Q})$, but act on $\mathbf{m} \in \mathbb{C}^4$.

⁹Recall that for two groups G and H , a group homomorphism $\varphi : G \rightarrow \text{Aut}(H)$ defines a semidirect product $H \rtimes_{\varphi} G \subset H \times G$ with the multiplication $(h_1, g_1)(h_2, g_2) := (h_1 \varphi(g_1)(h_2), g_1 g_2)$. For $(h, g) \in H \rtimes_{\varphi} G$, the inverse is found as $(\varphi(g^{-1})(h^{-1}), g^{-1})$.

The moduli spaces of the cases A–G of Table 2.2 are related by \mathcal{T} in the following way. We have that $\mathbf{m}_A, \mathbf{m}_C, \mathbf{m}_F$ are invariant under \mathcal{T} . Case A is invariant under both \mathcal{T} and \mathcal{S} . The \mathcal{S} -transformation relates cases B and C, as well as E and F, while leaving cases D and G invariant. We depict the relation among cases B, C and D in Fig. 2.11. For the cases E, F and G, there is an analogous diagram. An instance of these relations

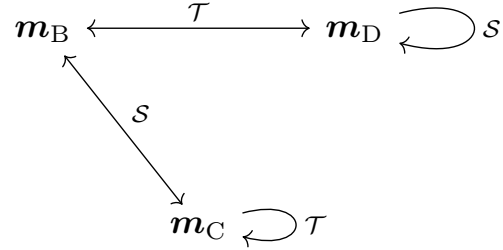

Fig. 2.11 Relation among $\mathbf{m}_B = (m, m, m, m)$, $\mathbf{m}_C = (2m, 0, 0, 0)$ and $\mathbf{m}_D = (m, m, m, -m)$.

is that the weights of the singular structure on the Coulomb branch are invariant under those spaces that are related by triality,

$$\mathbf{k}(\mathcal{T}\mathbf{m}) = \mathbf{k}(\mathbf{m}). \quad (2.88)$$

Using the action of the $\text{SO}(8)$ flavour group, a large range of masses with equivalent duality diagrams can be reached. For example, the mass $\mathbf{m} = (2m, 0, 0, 0)$ is related to $\mathbf{m} = (0, 0, 0, 2m)$ by an $\text{SO}(8)$ rotation. The first one is invariant under \mathcal{T} while the second one is not. The orbit under \mathcal{T} and \mathcal{S} for the case $\mathbf{m} = \mathbf{m}_B = (2m, 0, 0, 0)$ is, as we have just discussed, given by Fig. 2.11, while that of $\mathbf{m} = (0, 0, 0, 2m)$ is given in Fig. 2.12. We see that it is of order six, and includes different relative signs compared to \mathbf{m}_A and \mathbf{m}_D . On closer inspection, we note that the mass vectors come in pairs differing by an overall sign, which is an element of $\text{SO}(8)$. Thus identifying the mass vectors related by $\text{SO}(8)$ in diagram 2.12, we find that it is equivalent to diagram 2.11.

2.3.2 Group action

The action

$$\begin{aligned} \mathcal{T} \times \mathcal{M} &\longrightarrow \mathcal{M} \\ (g, \mathbf{m}) &\longmapsto g \cdot \mathbf{m} \end{aligned} \quad (2.89)$$

of the triality group \mathcal{T} on mass space \mathcal{M} can be studied in great detail. It is easy to check that the action is faithful¹⁰, but neither free¹¹ nor transitive¹².

¹⁰For every $g \neq h \in \mathcal{T}$ there exists an $\mathbf{m} \in \mathcal{M}$ such that $g \cdot \mathbf{m} \neq h \cdot \mathbf{m}$.

¹¹A group action is free if it has no fixed points, but $\mathbf{m} = 0$ is a fixed point for any $g \in \mathcal{T}$.

¹²For each pair $\mathbf{m}, \tilde{\mathbf{m}} \in \mathcal{M}$ there exists $g \in \mathcal{T}$ such that $g \cdot \mathbf{m} = \tilde{\mathbf{m}}$. A counterexample would be $\mathbf{m} = 0$ and $\tilde{\mathbf{m}} \neq 0$.

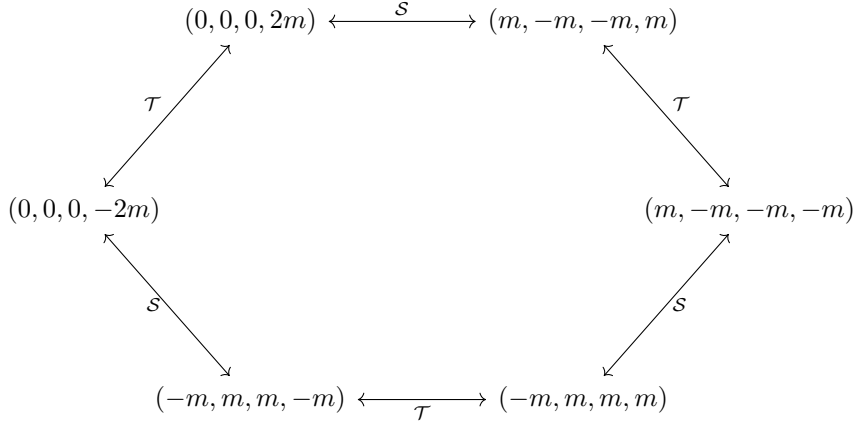

Fig. 2.12 Orbit of the mass vector $\mathbf{m} = (0, 0, 0, 2m)$ under \mathcal{T} and \mathcal{S} .

Up to conjugation, $S_3 \cong \mathcal{T}$ has four subgroups. They are: the trivial group \mathbb{Z}_1 , the symmetric group $S_2 \cong \mathbb{Z}_2$, the alternating group $A_3 \cong \mathbb{Z}_3$, and S_3 itself. They have order 1, 2, 3, and 6, respectively. All three proper subgroups are abelian. For a given \mathbf{m} , triality thus not always act by the full S_3 but rather by a subgroup. For every $\mathbf{m} \in \mathcal{M}$ we can study the orbit $\mathcal{T} \cdot \mathbf{m} = \{g \cdot \mathbf{m} \mid g \in \mathcal{T}\}$. The sets of orbits of \mathcal{M} then give a partition of \mathcal{M} under the action (2.89).

First, notice that since \mathcal{T} is a finite group, all elements have finite order. In particular, $\mathcal{T}^2 = \mathcal{S}^2 = (\mathcal{T}\mathcal{S}\mathcal{T})^2 = \mathbb{1}$ and $(\mathcal{S}\mathcal{T})^3 = (\mathcal{T}\mathcal{S})^3 = \mathbb{1}$. The stabiliser subgroup of a mass $\mathbf{m} \in \mathcal{M}$ is defined as $\mathcal{I}_m = \{g \in \mathcal{T} \mid g \cdot \mathbf{m} = \mathbf{m}\}$. By the orbit-stabiliser theorem

$$|\mathcal{T} \cdot \mathbf{m}| = |\mathcal{T}|/|\mathcal{I}_m|, \quad (2.90)$$

it suffices to study the fixed point equations in order to identify the stabiliser subgroups $\{\mathbb{Z}_1, S_2, A_3, S_3\}$ with the subgroups of \mathcal{T} . It is straightforward to identify the fixed point loci

$$\begin{aligned} \mathcal{L}_{\mathcal{T}} &= \{\mathbf{m} \in \mathcal{M} \mid m_4 = 0\}, \\ \mathcal{L}_{\mathcal{S}} &= \{\mathbf{m} \in \mathcal{M} \mid m_1 = m_2 + m_3 + m_4\}, \\ \mathcal{L}_{\mathcal{S}\mathcal{T}\mathcal{S}} &= \{\mathbf{m} \in \mathcal{M} \mid m_1 = m_2 + m_3 - m_4\}, \\ \mathcal{L}_{\mathcal{S}\mathcal{T}} = \mathcal{L}_{\mathcal{T}\mathcal{S}} &= \{\mathbf{m} \in \mathcal{M} \mid m_1 = m_2 + m_3 \text{ and } m_4 = 0\}, \end{aligned} \quad (2.91)$$

where $\mathcal{L}_g = \{\mathbf{m} \in \mathcal{M} \mid g \cdot \mathbf{m} = \mathbf{m}\}$. For \mathbf{m} in precisely one of $\mathcal{L}_{\mathcal{T}}$, $\mathcal{L}_{\mathcal{S}}$ or $\mathcal{L}_{\mathcal{S}\mathcal{T}\mathcal{S}}$, one finds that $|\mathcal{T} \cdot \mathbf{m}| = 3$. From (2.90) it then follows that $|\mathcal{I}_m| = 2$, such that $\mathcal{I}_m \cong S_2$. In fact, since \mathcal{T} , \mathcal{S} and $\mathcal{S}\mathcal{T}\mathcal{S}$ are all order 2 elements of \mathcal{T} , the stabiliser groups \mathcal{I}_m for \mathbf{m} in either of the three loci are precisely the three order 2 conjugate subgroups of $\mathcal{T} \cong S_3$.

The intersection

$$\mathcal{L}_1 = \mathcal{L}_\mathcal{T} \cap \mathcal{L}_\mathcal{S} = \{\mathbf{m} \in \mathcal{M} \mid m_1 = m_2 + m_3 \text{ and } m_4 = 0\} \quad (2.92)$$

is the locus of triality invariant masses, $\mathcal{T} \cdot \mathbf{m} = \mathbf{m}$. Thus, according to (2.90) we have $|\mathcal{T}_\mathbf{m}| = 6$ for such masses, such that indeed $\mathcal{T}_\mathbf{m} = \mathcal{T}$. For the last locus in (2.91), we see immediately that $\mathcal{L}_{\mathcal{S}\mathcal{T}} = \mathcal{L}_{\mathcal{T}\mathcal{S}} = \mathcal{L}_\mathcal{T} \cap \mathcal{L}_\mathcal{S}$ contains precisely the invariant masses. Therefore, if \mathbf{m} is kept fixed by either $\mathcal{T}\mathcal{S}$ or $\mathcal{S}\mathcal{T}$ then it is also fixed by both \mathcal{T} and \mathcal{S} and therefore by all of \mathcal{T} . Since $\mathcal{S}\mathcal{T}$ and $\mathcal{T}\mathcal{S}$ are the only elements of \mathcal{T} of order 3, there is actually no mass \mathbf{m} such that $\mathcal{T} \cdot \mathbf{m}$ has 2 elements, and so there is no stabiliser subgroup isomorphic to A_3 . By case analysis, it is also easy to prove that the set $\mathcal{T} \cdot \mathbf{m}$ has 1, 3 or 6 elements.

Let us summarise. If $\mathbf{m} \in \mathcal{L}_1$, it is invariant under \mathcal{T} . If \mathbf{m} is in any of $\mathcal{L}_\mathcal{T}$, $\mathcal{L}_\mathcal{S}$ or $\mathcal{L}_{\mathcal{S}\mathcal{T}\mathcal{S}}$, it could be in the intersection of any two of them. These intersections are however all equal to \mathcal{L}_1 , which is of course because any two elements of $\{\mathcal{T}, \mathcal{S}, \mathcal{S}\mathcal{T}\mathcal{S}\}$ generate \mathcal{T} . This is depicted in Fig. 2.13.

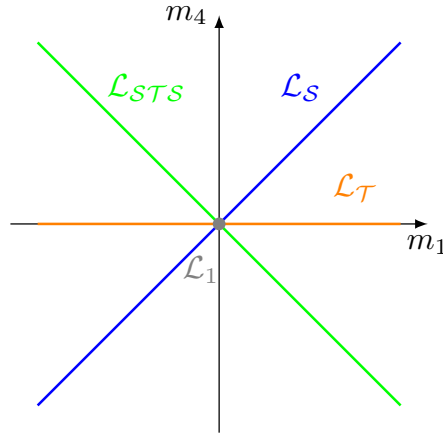

Fig. 2.13 The loci (2.91) with nontrivial stabiliser groups on the subspace $m_2 = m_3 = 0$ in \mathcal{M} . They all mutually intersect in the locus \mathcal{L}_1 of triality invariant masses.

If \mathbf{m} is then an element of

$$\mathcal{L}_3 = \mathcal{L}_\mathcal{T} \cup \mathcal{L}_\mathcal{S} \cup \mathcal{L}_{\mathcal{S}\mathcal{T}\mathcal{S}} \setminus \mathcal{L}_1, \quad (2.93)$$

then the stabiliser group of \mathbf{m} is isomorphic to S_2 . If \mathbf{m} does not lie in either \mathcal{L}_1 or \mathcal{L}_3 , then there is no remaining symmetry. It lies in

$$\mathcal{L}_6 = \mathcal{M} \setminus \mathcal{L}_1 \cup \mathcal{L}_3, \quad (2.94)$$

and its stabiliser group is trivial.

2.3.3 Order parameters and bimodular forms

The massless case where $\mathbf{m}_0 = (0, 0, 0, 0)$ is very simple, as $j(\tau) = \mathcal{J}(u, 0, \tau_0) = j(\tau_0)$ and therefore

$$\tau(u) = \tau_0 \quad (2.95)$$

is constant over the whole Coulomb branch $\mathcal{B}_4 \ni u$. In other words, the coupling τ is fixed and thus does not run, which is a consequence of the massless $N_f = 4$ theory being exactly superconformal. There are six singularities, which all sit at the origin $u = 0$ and form the non-abelian Coulomb point with a five quaternionic-dimensional Higgs branch [70].

To make the analysis in the previous sections more explicit, we can study some less trivial cases. Namely, the three cases E, F and G, with $\mathbf{m}_E = (m, m, \mu, \mu)$, $\mathbf{m}_F = (m + \mu, m - \mu, 0, 0)$ and $\mathbf{m}_G = (m, m, \mu, -\mu)$. The action of \mathcal{T} and \mathcal{S} on these theories was shown in Fig. 2.11. By taking various limits of the masses we can further use these three cases to recover the four cases A, B, C and D of Table 2.2. For example, if we send $\mu \rightarrow 0$ all three cases become case A, while if we send $\mu \rightarrow m$ we see that E becomes B, F becomes C and G becomes D. However, due to the fact that we now have two distinct mass parameters, the theories become more complicated, in the same way as discussed for the asymptotically free theories in Sec. 2.1, e.g., superconformal fixed points of Argyres-Douglas (AD) type appear, as well as branch points due to square roots [70].

By following the procedure outlined in Sec. 2.1 we can find the order parameters

$$\begin{aligned} u_E &= \frac{\vartheta_3(\tau_0)^4}{6(\lambda - \lambda_0)(\lambda\lambda_0 - 1)} \left[(m^2 + \mu^2)(1 + \lambda_0)(\lambda_0 + \lambda(2 + \lambda_0(\lambda - 6 + 2\lambda_0))) \right. \\ &\quad \left. + 3(\lambda^2 - 1)(\lambda_0 - 1)\lambda_0 \sqrt{(m^2 - \mu^2)^2 + 4m^2\mu^2 \frac{\lambda}{\lambda_0} \frac{(\lambda_0 - 1)^2}{(\lambda - 1)^2}} \right], \\ u_F &= \frac{\vartheta_3(\tau_0)^4}{6(\lambda - \lambda_0)(\lambda(\lambda_0 - 1) - \lambda_0)} \left[(m^2 + \mu^2)(\lambda_0 - 2)(\lambda^2(\lambda_0 - 1) + 2\lambda_0^2(\lambda - 1)) \right. \\ &\quad \left. + 3(\lambda - 2)(\lambda_0 - 1)\lambda_0 \sqrt{(m^2 - \mu^2)^2 \lambda^2 + 4m^2\mu^2 \lambda_0^2 \frac{\lambda - 1}{\lambda_0 - 1}} \right], \\ u_G &= \frac{\vartheta_3(\tau_0)^4}{6(\lambda^2 - \lambda - \lambda_0^2 + \lambda_0)} \left[(m^2 + \mu^2)(2\lambda_0 - 1)((\lambda_0 - 1)\lambda_0 + 2\lambda^2 - 2\lambda) \right. \\ &\quad \left. + 3(2\lambda - 1)(\lambda_0 - 1)\lambda_0 \sqrt{(m^2 - \mu^2)^2 + 4m^2\mu^2 \frac{\lambda}{\lambda_0} \frac{\lambda - 1}{\lambda_0 - 1}} \right], \end{aligned} \quad (2.96)$$

where we have abbreviated $\lambda(\tau) = \lambda$, $\lambda(\tau_0) = \lambda_0$.

We can note that, by acting on both τ and τ_0 at the same time, using $T : \lambda \mapsto \frac{\lambda}{\lambda-1}$ and $S : \lambda \mapsto 1 - \lambda$, we find

$$\begin{aligned} \mathcal{T} : \begin{cases} u_E(\tau + 1, \tau_0 + 1) = u_G(\tau, \tau_0), \\ u_F(\tau + 1, \tau_0 + 1) = u_F(\tau, \tau_0), \end{cases} \\ \mathcal{S} : \begin{cases} u_E(-\frac{1}{\tau}, -\frac{1}{\tau_0}) = \tau_0^2 u_F(\tau, \tau_0), \\ u_G(-\frac{1}{\tau}, -\frac{1}{\tau_0}) = \tau_0^2 u_G(\tau, \tau_0), \end{cases} \end{aligned} \quad (2.97)$$

which is the expected behaviour under the triality action of these transformations. Due to the square roots, the transformation on each parameter separately is however more subtle.

If we send $\mu \rightarrow 0$ we find that the order parameter of all three cases becomes the order parameter of case A,

$$u_A(\tau, \tau_0) = -\frac{m^2}{3} \vartheta_3(\tau_0)^4 \frac{\lambda(\tau_0)^2 + 2(\lambda(\tau) - 1)\lambda(\tau_0) - \lambda(\tau)}{\lambda(\tau_0) - \lambda(\tau)}. \quad (2.98)$$

Now the square roots have disappeared and we can more easily examine the function u_A . First of all, since all three cases E, F and G degenerated to the same function we directly see that under the simultaneous action of $\mathrm{SL}(2, \mathbb{Z})$ on both τ and τ_0 as in (2.97), we find

$$u_A(\gamma\tau, \gamma\tau_0) = (c\tau_0 + d)^2 u_A(\tau, \tau_0), \quad \gamma = \begin{pmatrix} a & b \\ c & d \end{pmatrix} \in \mathrm{SL}(2, \mathbb{Z}). \quad (2.99)$$

Secondly, since $\lambda(\tau)$ is a Hauptmodul for $\Gamma(2)$ we easily find that u_A transforms as a modular function for $\Gamma(2)$ when acting only on τ , while keeping τ_0 fixed, and as a weight two modular form when instead acting on τ_0 and keeping τ fixed. Following Definition 1 of Appendix B.4, we then say that $u_A : \mathbb{H} \times \mathbb{H} \rightarrow \mathbb{C}$ in (2.98) is a bimodular form of weight $(0, 2)$ for the triple

$$(\Gamma(2), \Gamma(2); \mathrm{SL}(2, \mathbb{Z})), \quad (2.100)$$

with trivial multipliers χ and ϕ . In fact, $m \mapsto u_A$ is a 1-parameter family of such bimodular forms.

If we instead take the limit $\mu \rightarrow m$ we find that $u_E \rightarrow u_B$, $u_F \rightarrow u_C$ and $u_G \rightarrow u_D$, with

$$\begin{aligned} u_B(\tau, \tau_0) &= -\frac{m^2}{3} \vartheta_2(\tau_0)^2 \vartheta_3(\tau_0)^2 \frac{2f(\tau_0)^2 + f(\tau)f(\tau_0) - 12}{f(\tau_0) - f(\tau)}, \\ u_C(\tau, \tau_0) &= -\frac{m^2}{3} \vartheta_3(\tau_0)^2 \vartheta_4(\tau_0)^2 \frac{2\tilde{f}(\tau_0)^2 + (10\tilde{f}(\tau) + 1)\tilde{f}(\tau_0) + 2\tilde{f}(\tau)}{\tilde{f}(\tau_0)(\tilde{f}(\tau_0) - \tilde{f}(\tau))}, \\ u_D(\tau, \tau_0) &= -\frac{m^2}{3} i \vartheta_2(\tau_0)^2 \vartheta_4(\tau_0)^2 \frac{2\hat{f}(\tau_0)^2 + \hat{f}(\tau)\hat{f}(\tau_0) - 12}{\hat{f}(\tau_0) - \hat{f}(\tau)}, \end{aligned} \quad (2.101)$$

the order parameters of cases B, C and D, respectively, and where we further expressed the Hauptmodul of the congruence subgroups $\Gamma^0(4)$, $\Gamma_0(4)$ and $\widetilde{\Gamma^0(4)} = T\Gamma^0(4)T^{-1}$, respectively, as

$$\begin{aligned} f &:= \frac{\vartheta_2^4 + \vartheta_3^4}{\vartheta_2^2 \vartheta_3^2}, \\ \tilde{f} &:= \frac{\vartheta_3^2 \vartheta_4^2}{(\vartheta_3^2 - \vartheta_4^2)^2}, \\ \hat{f}(\tau) &:= f(\tau + 1) = i \frac{\vartheta_2(\tau)^4 - \vartheta_4(\tau)^4}{\vartheta_2(\tau)^2 \vartheta_4(\tau)^4}. \end{aligned} \quad (2.102)$$

Similar to the case A, we now find that these three order parameters transforms as bimodular forms for the triples

$$\begin{aligned} u_B &: \quad (\Gamma^0(4), \Gamma^0(4); \Gamma^0(2)), \\ u_C &: \quad (\Gamma_0(4), \Gamma_0(4); \Gamma_0(2)), \\ u_D &: \quad (\widetilde{\Gamma^0(4)}, \widetilde{\Gamma^0(4)}; \Gamma_\theta), \end{aligned} \quad (2.103)$$

See Appendix A for the relevant definitions. However, as seen from Fig. 2.11 we further expect them to transform into each other under the simultaneous action of the whole group of $SL(2, \mathbb{Z})$. This can be checked explicitly, and we thus find that they satisfy Definition 2 in Appendix B.4 of a vector valued bimodular form.

Another new phenomena in $N_f = 4$, as compared to the asymptotically free theories, is that there is now also a singularity in the interior of the fundamental domain where $\tau \rightarrow \tau_0$ and $u \rightarrow \infty$, as can be seen from (2.96). This is also present in the theory with one adjoint hypermultiplet [39].

Special points

As in the theories with $0 < N_f \leq 3$ there is a plethora of theories in the moduli space of generic masses $N_f = 4$ where the singularity of the fibres is of a higher type, in the

sense of Kodaira, and where mutually non-local dyons become massless [70].¹³ These can be classified similarly as in the asymptotically free theories by finding the values of \mathbf{m} and u such that $g_2 = g_3 = 0$. Compare with the discussion in Sec. 2.1.2.

As we have just seen, there are also theories where the order parameter has branch points due to square roots, exactly as we saw in the cases with $0 < N_f \leq 3$. The natural interpretation that arose from the analysis of the asymptotically free theories in [2] and Sec. 2.1, is to think of the branch points as signalling a first order phase transition connected to the second order transition that is the Argyres-Douglas (AD) theories. This implies that we might expect to have branch cuts whenever we have an AD theory. It is straightforward to check that the cases A, B, C and D of $N_f = 4$ only have as superconformal fixed points $m \rightarrow 0$, $u \rightarrow 0$, so that the lack of branch points in these theories is consistent with the above claim. For the more general cases the story changes as we have just seen for cases E, F and G. Let us therefore study the special points of these theories in more detail.

AD points

Similar to what we did in Sec. 2.1.2, we define the AD loci as the values of the masses for which there exists an AD theory. This can then be expressed as the zero loci of the polynomials

$$\begin{aligned} P_E^{\text{AD}} &= (m^2 \lambda_0 - \mu^2) (\mu^2 \lambda_0 - m^2) \\ P_F^{\text{AD}} &= (m^2 (\lambda_0 - 1) + \mu^2) (\mu^2 (\lambda_0 - 1) + m^2), \\ P_G^{\text{AD}} &= (m^2 (\lambda_0 - 1) - \lambda_0 \mu^2) (\mu^2 (\lambda_0 - 1) - \lambda_0 m^2), \end{aligned} \quad (2.104)$$

Since $T : \lambda \mapsto \frac{\lambda}{\lambda-1}$ and $S : \lambda \mapsto 1 - \lambda$ we see that the AD loci also satisfy triality, such that if we act on P_E^{AD} with T we get P_G^{AD} (up to an overall non-zero factor which is not important since we are looking for the roots of the polynomial) and if we act with S we get P_F^{AD} .

By tuning the mass to any of the AD values we find that three singularities merge. Depending on which AD mass is chosen, one of the degeneracy two singularities u_{m_i} merge with one of the degeneracy one singularities u_{\pm} . This gives rise to a singular fibre of type *III* ($\text{ord}(g_2, g_3, \Delta) = (1, 2, 3)$), implying that three mutually non-local states are becoming massless [70]. It is now easy to find closed expressions for u for any of the three theories, and the square roots all disappear.¹⁴

¹³Note however that we should not expect to find any *new* types of theories, compared to the ones of $N_f \leq 3$ in this moduli space, but only types *II-IV* [70]. This is because an overall scaling of the masses is not a true parameter of the theory.

¹⁴Note that for some of the values of the masses the solution we have picked for general m and μ will become a constant function of τ , this is because the chosen solution corresponds to the solution for u near a singularity that merges with others to become the AD singularity.

To give an example we take case E and tune the masses such that $m = \mu\sqrt{\lambda_0}$, where $\sqrt{\lambda} = \frac{\vartheta_2^2}{\vartheta_3^2}$ is a holomorphic modular form. The order parameter becomes

$$u_E^{\text{AD}} = \frac{2\mu^2\vartheta_3(\tau_0)^4(\lambda_0 - 1)(\lambda_0(\lambda_0(f_2 + 8(7 + \lambda_0))) - 56) - 8}{3\lambda_0(32 + f_2 - 16\lambda_0) - 16}, \quad (2.105)$$

where $f_2 = f_2(\tau) = 16\frac{\vartheta_4(\tau)^8}{\vartheta_2(\tau)^4\vartheta_3(\tau)^4}$ is a Hauptmodul of the index 3 congruence subgroup $\Gamma^0(2) \subset \text{SL}(2, \mathbb{Z})$. It is straightforward to check that u_E^{AD} has weight 0 under separate transformations on τ for $\Gamma^0(2)$, and weight 2 under separate transformations on τ_0 for $\Gamma(2)$. Thus, the group of simultaneous transformations contains $\Gamma^0(2) \cap \Gamma(2) \cong \Gamma(2)$. We therefore find that u_E^{AD} is a bimodular form of weight $(0, 2)$ for the triple

$$(\Gamma^0(2), \Gamma(2); \Gamma(2)). \quad (2.106)$$

Note that this is our first example of a bimodular form that has two different modular groups for the two couplings. The fact that the index in $\text{SL}(2, \mathbb{Z})$ of the modular group of τ shrinks by the number of merged non-local singularities, $2 + 1$ in this case, is the expected behaviour of AD theories, as we argued for in Sec. 2.1.2.

Since the two separate duality groups, $\Gamma^0(2)$ and $\Gamma(2)$, are different, we cannot choose the fundamental domains for τ and τ_0 to coincide as in previous cases. Instead, we can choose the fundamental domain for τ as a subset of that for τ_0 . Equation (2.105) demonstrates that u_E^{AD} has a single pole as a function of $\tau \in \mathbb{H}/\Gamma^0(2)$ for fixed τ_0 , while it has two poles as function of $\tau_0 \in \mathbb{H}/\Gamma(2)$ for fixed τ . The two points in $\tau_0 \in \mathbb{H}/\Gamma(2)$ are related by an element in $\Gamma^0(2)/\Gamma(2)$.

We can further note that the AD mass, $m_{\text{AD}} = \mu\sqrt{\lambda_0}$, is not invariant under $\Gamma(2)$ acting on τ_0 , due to the square root. We rather have that $m_{\text{AD}} \rightarrow -m_{\text{AD}}$ under T^2 , which is of course another AD point of the theory, and the order parameters of the two theories are given by the same expression. Furthermore, acting with S and T on τ_0 sends this AD mass to the corresponding AD masses of cases F and G, respectively.

We also have the possibility of tuning τ_0 to a specific value such that more singularities merge. In the above solution, if we fix $\tau_0 = 1 + i$, or $\lambda_0 = -1$, we find that the remaining degeneracy two singularity merge with the degeneracy one singularity such that we get the weight vector $\mathbf{k} = (3, 3)$. The relation between the masses is now $m = i\mu$ and the order parameter is actually independent of τ , the curve is simply given by $\mathcal{J} = j(\tau_0) = 12^3$. Therefore, the coupling $\tau(u) = \tau_0 = 1 + i$ is fixed over the whole Coulomb branch. This is expected from the same argument as before since we merge two sets of 3 non-local singularities, such that the fundamental domain for τ just shrinks to a point τ_0 .

Branch points

As previously mentioned, in the more generic cases there will also be branch points. For the theories E, F and G these are given by the branch points of the square roots in 2.96,

$$\begin{aligned}
 \text{E: } \quad & \frac{\lambda}{(\lambda-1)^2} = -\frac{\lambda_0}{(\lambda_0-1)^2} \frac{(m^2-\mu^2)^2}{4m^2\mu^2}, \\
 \text{F: } \quad & \frac{\lambda-1}{\lambda^2} = \frac{1-\lambda_0}{\lambda_0} \frac{(m^2-\mu^2)^2}{4m^2\mu^2}, \\
 \text{G: } \quad & \lambda(\lambda-1) = \lambda_0(1-\lambda_0) \frac{(m^2-\mu^2)^2}{4m^2\mu^2}.
 \end{aligned} \tag{2.107}$$

In the u -plane they are given by

$$\begin{aligned}
 \text{E: } \quad & u_{\text{bp}} = -\vartheta_3(\tau_0)^4 (1+\lambda_0) \frac{m^4 - 4m^2\mu^2 + \mu^4}{3(m^2 + \mu^2)}, \\
 \text{F: } \quad & u_{\text{bp}} = -\vartheta_3(\tau_0)^4 (\lambda_0 - 2) \frac{m^4 - 4m^2\mu^2 + \mu^4}{3(m^2 + \mu^2)}, \\
 \text{G: } \quad & u_{\text{bp}} = \vartheta_3(\tau_0)^4 (2\lambda_0 - 1) \frac{m^4 - 4m^2\mu^2 + \mu^4}{3(m^2 + \mu^2)}.
 \end{aligned} \tag{2.108}$$

It is straightforward to see that also these points satisfy triality.

We can now use the same methods as in 2.1 and 2.2 to construct fundamental domains of the theories with four flavours and study the decoupling to other theories. For example, in the case of theory A we get the domain in Fig. 2.14. From (2.96) we can also calculate other important functions, such as $\frac{du}{da}$, $\frac{du}{d\tau}$ and Δ , using the methods described in the previous Sections.

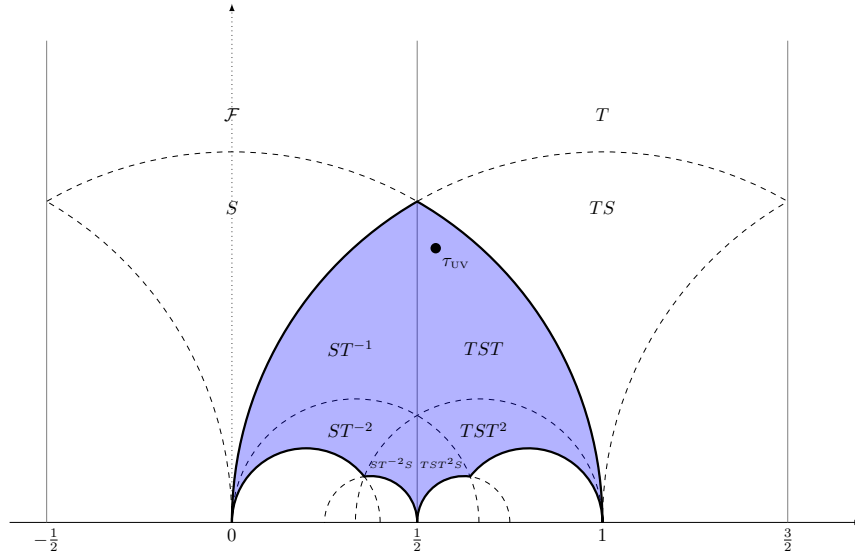

Fig. 2.14 Fundamental domain of the $N_f = 4$ theory with mass $\mathbf{m} = (m, m, 0, 0)$. The six singularities on the Coulomb branch \mathcal{B}_4 are described by the three cusps, each of width 2. The I_0^* singularity corresponding to $u = \infty$ sits at $\tau = \tau_0 = \tau_{UV}$.

This concludes our discussion of the modular properties of the $SU(2)$ SW theories with fundamental matter. We have seen that in general there are branch points in the order parameter as a function of the coupling. These branch points then make the modular transformations more subtle to understand. We have still showed how we can analyse the Coulomb branch in great detail and construct fundamental domains for the running coupling. In certain limits of the masses the fundamental domain changes. The branch points and their corresponding cuts provide a natural mechanism for these changes.

Chapter 3

Elliptic loci of $SU(3)$ vacua

Let us now return to the pure theory but change the gauge group to $SU(3)$. Instead of an elliptic curve the Seiberg-Witten curve will now be a genus two curve [33]. Many aspects of the non-perturbative dynamics have previously been analysed [92, 19], while we will focus on the modular properties of the theory. We will in particular study two subloci of the moduli space where one of the order parameters vanish, and see that the genus two curve degenerates to two elliptic curves. On these loci, we show how the non-vanishing order parameter can be expressed in terms of modular forms. This Chapter is based on the paper [1].

3.1 Seiberg-Witten geometry of $SU(3)$

Similar to the $SU(2)$ theory, the vector multiplet scalar ϕ can be gauge rotated into the Cartan subalgebra of $SU(3)$. Then, ϕ can be expanded in terms of the two Cartan generators H_I , $I = 1, 2$, as

$$\phi = a_1 H_1 + a_2 H_2. \quad (3.1)$$

Non-vanishing vevs of ϕ break the gauge group in general to $U(1)^2$. We denote electric-magnetic charges under $U(1)^2$ as $\gamma = (p_1, p_2, q_1, q_2)$, where p_i are the magnetic and q_i the electric charges respectively. The period vector is denoted as $\pi = (a_{D,1}, a_{D,2}, a_1, a_2)^T$. The central charge for a generic γ is then given by $Z_\gamma = \gamma \cdot \pi$, where \cdot is the standard scalar product.

Classically, there are three singular points where gauge bosons are becoming massless. Their charge vectors are given by the roots of the gauge algebra such that the central charges take the form

$$\begin{aligned} Z_1 &= 2a_1 - a_2, \\ Z_2 &= 2a_2 - a_1, \\ Z_3 &= a_1 + a_2. \end{aligned} \quad (3.2)$$

Just as in the SU(2) theory, the Coulomb branch is parametrised by vevs of Casimirs of ϕ , $u_I \sim \langle \text{Tr} \phi^I \rangle$, $I = 2, 3$. Gauge invariant combinations for SU(3) are

$$\begin{aligned} u = u_2 &= \frac{1}{2} \langle \text{Tr}(\phi^2) \rangle_{\mathbb{R}^4} = a_1^2 + a_2^2 - a_1 a_2, \\ v = u_3 &= \frac{1}{3} \langle \text{Tr}(\phi^3) \rangle_{\mathbb{R}^4} = a_1 a_2 (a_1 - a_2). \end{aligned} \quad (3.3)$$

These relations can be rewritten in terms of two cubic equations for a_1 and a_2 as

$$\begin{aligned} a_1^3 - u a_1 - v &= 0, \\ a_2^3 - u a_2 + v &= 0. \end{aligned} \quad (3.4)$$

There is a spontaneously broken global $\mathbb{Z}_3 \times \mathbb{Z}_2$ symmetry acting on u and v by $u \mapsto \alpha u$ and $v \mapsto -v$, with $\alpha = e^{2\pi i/3}$. Classically, the discriminant is the determinant $\Delta_{\text{classical}}$ of the matrix $B_{IJ} = \frac{\partial u_{I+1}}{\partial a_J}$. It reads

$$\Delta_{\text{classical}} = \det B_{IJ} = (a_1 - 2a_2)(2a_1 - a_2)(a_1 + a_2), \quad (3.5)$$

and vanishes when one of the gauge bosons (3.2) becomes massless.

Let us denote the space parametrised by u and v by \mathcal{U} . We parametrise points on this space by $(\underline{u}, v) \in \mathcal{U}$, where \underline{u} is the normalised parameter, $\underline{u} = \sqrt[3]{\frac{4}{27}} u$. We further introduce the two loci of \mathcal{U} where one of the order parameters vanish, \mathcal{E}_u where $v = 0$ and \mathcal{E}_v where $u = 0$. The moduli space \mathcal{U} parametrises a complex two-dimensional family of hyperelliptic curves of genus two [93, 94],

$$y^2 = (x^3 - u x - v)^2 - \Lambda^6, \quad (3.6)$$

where $\Lambda = \Lambda_{\text{SU}(3)}$ is the dynamically generated scale. The discriminant of this curve

$$\Delta_\Lambda = \Lambda^{18} (4u^3 - 27(v + \Lambda^3)^2)(4u^3 - 27(v - \Lambda^3)^2). \quad (3.7)$$

This can be viewed as a product of the discriminants of two elliptic curves whose v parameters are separated by $2\Lambda^3$. Note that the \mathbb{Z}_6 global symmetry leaves the discriminant invariant. It vanishes if and only if $\underline{u}^3 = (v \pm \Lambda^3)^2$. For the discussion in this Chapter we will mostly use units where the dynamical scale $\Lambda = 1$ and we note that it can always be restored from dimensional analysis.

If we restrict to $\text{Im } v = 0$, the zero locus of the discriminant describes six singular curves which intersect in the following points. On the $v = 0$ plane, there are four singularities, namely $\underline{u} \in \{\infty, 1, \alpha, \alpha^2\}$. On the other hand for $\underline{u} = 0$, there are two singularities at $v = \pm 1$. These are the Argyres-Douglas (AD) points, where mutually non-local BPS states become massless and the theory becomes superconformal [9]. Analogous to what we saw in the SU(2) theories with matter. In fact, the AD theories

appearing in the pure SU(3) are of the same type as those appearing in the $N_f = 1$ SU(2) theory [70]. Figure 3.1 sketches the singular lines on the subset of \mathcal{U} where $\text{Im } v = 0$. The singular lines represent regions in \mathcal{U} where the effective action of the pure $\mathcal{N} = 2$ theory becomes singular, and they are associated with vacua where hypermultiplets become massless.

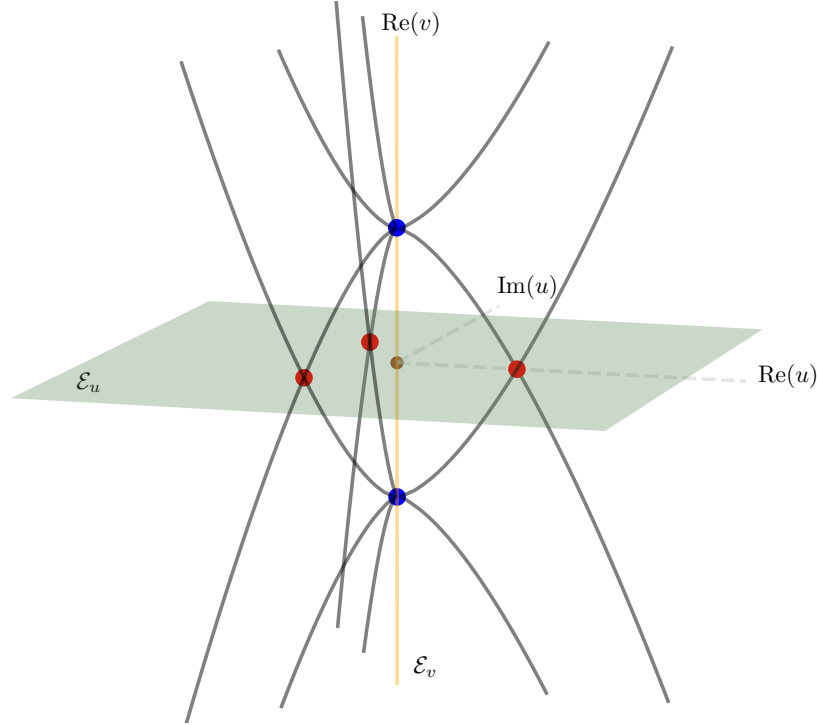

Fig. 3.1 Singular lines $\Delta(u, v) = 0$ in the SU(3) moduli space with $\text{Im } v = 0$, associated to massless dyons [95]. The red dots represent the strong coupling points $(\underline{u}, v) = (1, 0)$, $(\alpha, 0)$ and $(\alpha^2, 0)$, with $\alpha = e^{2\pi i/3}$, on the $v = 0$ plane \mathcal{E}_u , where two singular lines intersect. The blue dots represent the AD points $(\underline{u}, v) = (0, 1)$ and $(0, -1)$ respectively, where three singular lines intersect. They lie on \mathcal{E}_v , which is represented by the $\text{Re } v$ axis here. The two loci \mathcal{E}_u and \mathcal{E}_v intersect in the origin $(u, v) = (0, 0)$ (brown).

Similarly to the SU(2) case, the periods transform under monodromies which generate the duality group of the theory. The classical part of the monodromy group is given by the Weyl group of the SU(3) root lattice, which acts as reflections on lines perpendicular to the positive roots. The perturbative quantum correction comes from the one-loop effective action. It contributes to the prepotential as

$$F_{1\text{-loop}} = \frac{i}{2\pi} \sum_{\alpha} Z_{\alpha}^2 \log Z_{\alpha}, \quad (3.8)$$

where the sum runs over all positive roots α_1 , α_2 and $\alpha_3 = \alpha_1 + \alpha_2$. Here, Z_{α} are the central charges (3.2) of the gauge bosons.

The semi-classical monodromies can be derived in the following way. The Weyl group of the root lattice A_2 is generated by two reflections, r_1 and r_2 . The element r_k reflects the root lattice on the line perpendicular to α_k . For instance, r_2 induces the

map $\alpha_2 \mapsto -\alpha_2$, $\alpha_1 \mapsto \alpha_1 + \alpha_2$. Using (3.2), we find that $a_1 \mapsto a_1$ and $a_2 \mapsto a_1 - a_2$. The semi-classical transformation of the dual variables can be obtained using (3.8) and the fact that, semi-classically, $a_{D,I} = \frac{\partial F_{1\text{-loop}}}{\partial a_I}$ holds. The crucial insight is that $Z_2 \mapsto -Z_2$ induces a shift of πi due to the logarithm, and the result can be written as an integer linear combination of the periods. The other two Weyl elements transform a_1 and a_2 in the following way,

$$\begin{aligned} r_1 : (a_1, a_2) &\mapsto (a_2 - a_1, a_2), \\ r_2 : (a_1, a_2) &\mapsto (a_1, a_1 - a_2), \\ r_3 : (a_1, a_2) &\mapsto (-a_2, -a_1). \end{aligned} \tag{3.9}$$

The corresponding monodromies can be obtained in a similar fashion, the result is

$$\mathcal{M}^{(r_1)} = \begin{pmatrix} -1 & 0 & 4 & -2 \\ 1 & 1 & -2 & 1 \\ 0 & 0 & -1 & 1 \\ 0 & 0 & 0 & 1 \end{pmatrix}, \quad \mathcal{M}^{(r_2)} = \begin{pmatrix} 1 & 1 & 1 & -2 \\ 0 & -1 & -2 & 4 \\ 0 & 0 & 1 & 0 \\ 0 & 0 & 1 & -1 \end{pmatrix}, \quad \mathcal{M}^{(r_3)} = \begin{pmatrix} 0 & -1 & 1 & -2 \\ -1 & 0 & 4 & 1 \\ 0 & 0 & 0 & -1 \\ 0 & 0 & -1 & 0 \end{pmatrix}, \tag{3.10}$$

which satisfy $\mathcal{M}^{(r_3)} = \mathcal{M}^{(r_2)}\mathcal{M}^{(r_1)}(\mathcal{M}^{(r_2)})^{-1}$ [33].

3.2 Non-perturbative analysis

The non-perturbative analysis can be approached in a few different ways. We will first discuss the use of hypergeometric functions as solutions of a Picard-Fuchs type system of differential equations satisfied by the periods of the SW solution. After this we will relate the SW curve to a generic form of a genus two curve where absolute invariants, similar to the j -invariant of the elliptic curve, can be used to express the order parameters in terms of modular forms.

3.2.1 Picard-Fuchs solution

One way to find the non-perturbative solution is to notice that the periods satisfy second order partial differential equations of Picard-Fuchs (PF) type, whose solution space is spanned by the generalised hypergeometric function F_4 of Appell [95]. We review some aspects of the PF solution in the following, and leave further details for Appendix C. We study two interesting regions, one where u is large and v small, and the other one where v is large and u is small.

The non-perturbative effective action is characterised by the holomorphic prepotential F , which allows to define the dual periods $a_{D,I} = \frac{\partial F}{\partial a_I}$. Both periods a_I and $a_{D,I}$

are given by linear combinations of Appell functions. The large u expansion reads [95]

$$\begin{aligned} a_{D,1}(u, v) &= -\frac{i}{2\pi} \left(\sqrt{u} + \frac{3v}{2u} \right) \log\left(\frac{27}{4u^3}\right) - \frac{1}{\pi} \left(\frac{i}{2} + 2\alpha_1 \right) \sqrt{u} + \dots, \\ a_1(u, v) &= \sqrt{u} + \frac{1}{2} \frac{v}{u} + \dots, \end{aligned} \quad (3.11)$$

with $a_{D,2}(u, v) = a_{D,1}(u, -v)$, $a_2(u, v) = a_1(u, -v)$ and $\alpha_1 \in \mathbb{C}$ a constant (see Appendix C.2). The coupling constants of the $U(1)^2$ theory, $\tau_{IJ} = \frac{\partial a_{D,I}}{\partial a_J}$, are determined using the chain rule,

$$\tau_{11}(u, v) = \tau_{22}(u, -v) = \frac{i}{\pi} \log(8u^3) + \frac{9iv}{2\pi} u^{-3/2} - \left(\frac{129i}{32\pi} + \frac{63iv^2}{8\pi} \right) u^{-3} + \dots, \quad (3.12)$$

The off-diagonal τ_{12} is given by the series

$$\tau_{12}(u, v) = -\frac{\tau_{11}(u, v) + \tau_{22}(u, v)}{4} - \frac{1}{2\pi i} \log(8) + \frac{1}{2\pi i} \frac{27}{4} f(u, v), \quad (3.13)$$

where

$$f(u, v) = \frac{(1-4v^2)}{8} u^{-3} + \left(\frac{453}{1024} - 3v^2 - \frac{31}{16} v^4 \right) u^{-6} + \dots \quad (3.14)$$

Similarly, we find that the large v expansion of the coupling matrix reads (see Appendix C.3 for details, $\omega = e^{\pi i/6}$)

$$\tau_{11} \sim \frac{i}{\pi} \log(108v^2) - 1 + \frac{\omega}{\pi} uv^{-2/3} + \frac{\omega^5}{6\pi} u^2 v^{-4/3} - \left(\frac{11i}{18\pi} + \frac{4i}{27\pi} u^3 \right) v^{-2} + \dots, \quad (3.15)$$

and τ_{12} and τ_{22} are given by similar series. At $u = 0$ we have $\tau_{11} = \tau_{22} + 1$ and $\tau_{12} = -\frac{\tau_{11}}{2} + 1$.

3.2.2 Invariants of genus two curves

Every genus two hyperelliptic curve can be brought to the Rosenhain form [96]

$$y^2 = x(x-1)(x-\lambda_1)(x-\lambda_2)(x-\lambda_3). \quad (3.16)$$

The three roots λ_i of the polynomial are also referred to as *Rosenhain invariants*. These invariants are complementary to the Igusa invariants, [97, 98], which we will discuss below.

By a lemma of Picard, the Rosenhain invariants can be expressed in terms of even theta constants as

$$\lambda_1 = \frac{\Theta_1^2 \Theta_3^2}{\Theta_2^2 \Theta_4^2}, \quad \lambda_2 = \frac{\Theta_3^2 \Theta_8^2}{\Theta_4^2 \Theta_{10}^2}, \quad \lambda_3 = \frac{\Theta_1^2 \Theta_8^2}{\Theta_2^2 \Theta_{10}^2}. \quad (3.17)$$

The functions Θ_j are instances of genus two Siegel modular forms,

$$\Theta \begin{bmatrix} a \\ b \end{bmatrix} (\Omega) = \sum_{k \in \mathbb{Z}^2} \exp \left(\pi i (k+a)^T \Omega (k+a) + 2\pi i (k+a)^T b \right), \quad (3.18)$$

where the entries of the column vectors a and b take values in the set $\{0, \frac{1}{2}\}$. The argument Ω is a 2×2 -matrix

$$\Omega = \begin{pmatrix} \tau_{11} & \tau_{12} \\ \tau_{12} & \tau_{22} \end{pmatrix}, \quad (3.19)$$

valued in the Siegel upper half-plane \mathbb{H}_2 . We refer to Appendix B.5 for a precise definition and references. The moduli space of genus two curves, \mathcal{M}_2 , is complex three-dimensional. Since the SW order parameters u and v are two complex parameters, the $SU(3)$ Coulomb branch maps out a complex two-dimensional space $\mathcal{U} \subset \mathcal{M}_2$ in the moduli space of genus two curves. In other words, \mathcal{U} is a divisor of \mathcal{M}_2 .

Another set of invariants for genus two curves are the Igusa invariants. There are five invariants J_2, J_4, J_6, J_8 and J_{10} which are the analogues of the functions g_2 and g_3 in the genus one case, in the sense that they are not absolute invariants. From these invariants we can define three absolute invariants

$$x_1 = 144 \frac{J_4}{J_2^2}, \quad x_2 = -1728 \frac{J_2 J_4 - 3J_6}{J_2^3}, \quad x_3 = 486 \frac{J_{10}}{J_2^5}. \quad (3.20)$$

These various functions can then be related to Siegel modular forms in a similar way as for the genus one curves.

To this end, we define

$$\psi_k(\tau) = \sum_{(C,D)} \det(C\tau + D)^{-k}, \quad (3.21)$$

where the sum is over all inequivalent bottom rows (C, D) of elements of $\mathrm{Sp}(4, \mathbb{Z})$. They are the normalised genus 2 Eisenstein series of even weight $k \geq 4$. We furthermore define two functions [99, 100]

$$\begin{aligned} \chi_{10} &= -\frac{43867}{2^{12} 3^5 5^2 7 \cdot 53} (\psi_4 \psi_6 - \psi_{10}), \\ \chi_{12} &= \frac{131 \cdot 593}{2^{13} 3^7 5^3 7^2 337} (3^2 7^2 \psi_4^3 + 2 \cdot 5^3 \psi_6^2 - 691 \psi_{12}), \end{aligned} \quad (3.22)$$

which are in the kernel of the Siegel operator Φ and therefore cusp forms. The ring $M_*(\Gamma_2)$ of Siegel modular forms on $\mathrm{Sp}(4, \mathbb{Z}) =: \Gamma_2$ is then generated by $\psi_4, \psi_6, \chi_{10}, \chi_{12}$ and χ_{35} [97], and every meromorphic Siegel modular form of weight 0 on $X_2 := \Gamma_2 \backslash \mathbb{H}_2$ is a rational function in the generators. The J -invariants are related to $M_*(\Gamma_2)$ by

[100, 101]

$$J_2 = -2^3 \cdot 3 \frac{\chi_{12}}{\chi_{10}}, \quad J_4 = 2^2 \psi_4, \quad J_6 = -\frac{2^3}{3} \psi_6 - 2^5 \frac{\psi_4 \chi_{12}}{\chi_{10}}, \quad J_{10} = -2^{14} \chi_{10}. \quad (3.23)$$

Note that χ_{10} is proportional to the discriminant of the curve and so we assume it is nonzero. We can see that $J_{\{2,4,6,10\}}$ are modular forms for Γ_2 of weight 2, 4, 6, 10. Inserting the J_i into (3.20) we find a more natural definition of the absolute invariants in terms of Siegel modular forms [98]

$$x_1 = \frac{\psi_4 \chi_{10}^2}{\chi_{12}^2}, \quad x_2 = \frac{\psi_6 \chi_{10}^3}{\chi_{12}^3}, \quad x_3 = \frac{\chi_{10}^6}{\chi_{12}^5}. \quad (3.24)$$

It is known that ψ_4 , ψ_6 , $-4\chi_{10}$ and $12\chi_{12}$ have integral Fourier coefficients which are relatively prime [102].

3.2.3 Seiberg-Witten curve in Rosenhain form

In this section, we will relate the $SU(3)$ Seiberg-Witten curve to the curve in Rosenhain form, which is a degree 5 equation.

To relate the Rosenhain curve (3.16) to the Seiberg-Witten curve (3.6), note that a degree 5 polynomial as in (3.16) can be obtained by a linear fractional transformation of a degree 6 hyperelliptic equation $y^2 = \prod_{j=1}^6 (x - r_j)$, which maps three of the roots to ∞ , 0 and 1. Linear fractional maps leave cross-ratios invariant, which is a convenient way to relate the λ_j to u and v . Let us define the cross-ratio of four points $z_i \in \mathbb{CP}^1$ as

$$C(z_1, z_2, z_3, z_j) = \frac{(z_1 - z_3)(z_2 - z_j)}{(z_1 - z_j)(z_2 - z_3)}, \quad (3.25)$$

such that $C(\{\infty, 0, 1, \lambda_j\}) = \lambda_j$.

Note that we have 120 different possibilities to map three roots among the $\{r_j\}$ to 0, 1, ∞ , and another 3! possibilities to identify the three cross-ratios in the hyperelliptic setting with the λ_j . By studying the large u expansions of these for non-zero v , one can easily identify which cross-ratios, in terms of the r_i , correspond to which λ_j . To this end, let $\alpha = e^{2\pi i/3}$ as before. The roots of the rhs of (3.6) are then given by (with $\Lambda = 1$)

$$\begin{aligned} r_1 &= s_+(u, v+1) + s_-(u, v+1), & r_4 &= s_+(u, v-1) + s_-(u, v-1), \\ r_2 &= \alpha s_+(u, v+1) + \alpha^2 s_-(u, v+1), & r_5 &= \alpha s_+(u, v-1) + \alpha^2 s_-(u, v-1), \\ r_3 &= \alpha^2 s_+(u, v+1) + \alpha s_-(u, v+1), & r_6 &= \alpha^2 s_+(u, v-1) + \alpha s_-(u, v-1), \end{aligned} \quad (3.26)$$

where

$$s_{\pm}(u, v) = \sqrt[3]{\frac{v}{2} \pm \sqrt{\frac{v^2}{4} - \frac{u^3}{27}}}. \quad (3.27)$$

To simplify notation, let us set $s_{\pm\pm} := s_{\pm}(u, v \pm 1)$. The large u , small v expansions for the roots are

$$\begin{aligned} r_1 &= \sqrt{u} + \frac{1+v}{2u} + \dots, & r_4 &= \sqrt{u} - \frac{1-v}{2u} + \dots, \\ r_2 &= -\sqrt{u} + \frac{1+v}{2u} + \dots, & r_5 &= -\sqrt{u} - \frac{1-v}{2u} + \dots, \\ r_3 &= -\frac{1+v}{u} + \dots, & r_6 &= \frac{1-v}{u} + \dots \end{aligned} \quad (3.28)$$

Plugging the weak-coupling expansions (3.12) into the Rosenhain invariants gives the leading behaviour for the λ_j . From this we can see that each invariant λ_j approaches 1 in the large u limit.

We continue by determining which of the 720 possible sets of cross-ratios matches with the theta constants. We have to determine which roots correspond to the first three points z_i , $i = 1, 2, 3$, in the cross-ratio (3.25). Since the three theta constants approach 1 in the large u limit, we should take for $\{z_1, z_2\}$ in (3.25) the roots which vanish in this limit, thus $\{r_3, r_6\}$. Together with the choice of z_2 , this reduces to 8 possible triplets. From a further comparison between the Rosenhain invariants and the cross-ratios, we determine that $z_1 = r_6$, $z_2 = r_3$ and $z_3 = r_2$. With $C_j := C(r_6, r_3, r_2, r_j)$ for $j = 1, 4$ and 5 , we arrive at

$$\lambda_1 = C_5, \quad \lambda_2 = C_1, \quad \lambda_3 = C_4. \quad (3.29)$$

These are three equations for five unknowns, namely τ_{11} , τ_{12} , τ_{22} , u and v . To make it more manifest that the right hand side depends on only two variables, let us express the cross-ratios C_j in terms of $s_{\pm\pm}$,

$$\begin{aligned} C_1 &= \alpha^2 \frac{[\alpha s_{+-} + s_{--} - s_{++} - \alpha s_{-+}] [s_{++} - \alpha s_{-+}]}{[\alpha^2 s_{+-} + \alpha s_{--} - s_{++} - s_{-+}] [s_{-+} - s_{++}]}, \\ C_4 &= -\frac{[\alpha s_{+-} + s_{--} - s_{++} - \alpha s_{-+}] [\alpha^2 s_{++} + \alpha s_{-+} - s_{+-} - s_{--}]}{3[s_{+-} - \alpha s_{--}] [s_{-+} - s_{++}]}, \\ C_5 &= -\alpha^2 \frac{[\alpha s_{+-} + s_{--} - s_{++} - \alpha s_{-+}] [\alpha s_{++} + s_{-+} - s_{+-} - \alpha s_{--}]}{3[s_{--} - s_{-+}] [s_{-+} - s_{++}]}. \end{aligned} \quad (3.30)$$

Note that these expressions are true on the full moduli space. For $u \neq 0$, we can define

$$X = \frac{s_{++}}{\sqrt{u/3}}, \quad Y = \frac{s_{+-}}{\sqrt{u/3}}, \quad (3.31)$$

such that $X^{-1} = s_{-+}/\sqrt{u/3}$ and $Y^{-1} = s_{--}/\sqrt{u/3}$, since $s_{++}s_{--} = u/3$. The cross-ratios can then be expressed as

$$\begin{aligned} C_1 &= -\alpha^2 \frac{X(X - \alpha Y)(X - Y^{-1})(X - \alpha X^{-1})}{(X^2 - 1)(X - \alpha^2 Y)(X - \alpha Y^{-1})}, \\ C_4 &= -\frac{1}{3} \alpha^2 \frac{(X - \alpha Y)^2 (X - Y^{-1})(X - \alpha Y^{-1})}{X(X^2 - 1)(Y - \alpha Y^{-1})}, \\ C_5 &= \frac{1}{3} \frac{(X - \alpha Y)(X - Y^{-1})^2 (X - \alpha^2 Y)}{X(X^2 - 1)(Y - Y^{-1})}. \end{aligned} \quad (3.32)$$

We thus see that the Coulomb branch can be identified with the zero-locus of the three equations (3.32) inside the space $(\lambda_1, \lambda_2, \lambda_3, X, Y)$. One may in principle eliminate X and Y to arrive at a single equation in terms of the λ_j . In the following two sections, we will restrict to the two one-dimensional sub-loci \mathcal{E}_u and \mathcal{E}_v of the solution space of (3.29), where $v = 0$ and $u = 0$ respectively.

Another natural method of attack would be the direct generalisation of what we did in the SU(2) theories. Namely, we calculate the absolute invariants of the SW curve and equate it with the absolute invariants expressed in modular forms as in (3.24). The absolute invariants of the SW curve are

$$\begin{aligned} x_1 &= 9 - \frac{162}{30 + 4u^3 - 27v^2} + \frac{81(5 - 36u^3)}{(30 + 4u^3 - 27v^2)^2}, \\ x_2 &= 27 \left(-1 + \frac{27}{30 + 4u^3 - 27v^2} + \frac{27(18u^3 - 1)}{(30 + 4u^3 - 27v^2)^2} - \frac{27(5 + 486u^3)}{(30 + 4u^3 - 27v^2)^3} \right), \\ x_3 &= \frac{243(729 - 216u^3 + 16u^6 - 1458v^2 - 216u^3v^2 + 729v^4)}{256(30 + 4u^3 - 27v^2)^5}. \end{aligned} \quad (3.33)$$

However, it turns out that equating these with the expressions in (3.24) and solving for u and v gives a very long and unusable answer, for this reason we do not print it here. One thing we can note, though, is that it comes with square roots of Siegel modular forms. In the SU(2) theories, the observation was that the branch points seem to always be connected, in some sense, to having AD points in the theory. See Chapter 5 for more on this. Based on this observation, the appearance of square roots in the order parameters of the full SU(3) theory is expected, since we know that there are also AD points [9].

3.3 Locus $\mathcal{E}_u: v = 0$

In this section we analyse the locus $v = 0$. We will demonstrate that the order parameter u can be expressed in terms of classical modular forms on this locus. In fact, we will arrive at two distinct expressions depending on a choice of effective coupling. In Section 3.5 we will discuss this from the geometric point of view.

3.3.1 Algebraic relations

On the locus $v = 0$ we have that $\tau_{11}(u, 0) = \tau_{22}(u, 0)$ and $\tau_{12}(u, 0)$ is given by (3.13). Let us analyse these coupling constants, now from the perspective of Section 3.2.3. For u large and positive, $s_{+\pm}$ has a large magnitude and phase $e^{\pi i/6}$. Similarly, the phase of $s_{-\pm}$ is approximately given by $e^{-\pi i/6}$. This means that

$$s_{--} = -\alpha s_{++}, \quad s_{+-} = -\alpha^2 s_{-+}, \quad X = -\alpha^2 Y^{-1}. \quad (3.34)$$

Using this and (3.31), we find that (3.32) now turns into

$$\begin{aligned} C_1 &= -\frac{(X + X^{-1})(X - \alpha X^{-1})}{(X - X^{-1})(X + \alpha X^{-1})}, \\ C_4 &= -\frac{1}{3} \frac{(X + X^{-1})^2}{(X - X^{-1})^2}, \\ C_5 &= +\frac{1}{3} \frac{(X + X^{-1})(X + \alpha X^{-1})}{(X - \alpha X^{-1})(X - X^{-1})}. \end{aligned} \quad (3.35)$$

Since the rhs of (3.35) depends only on one variable X , the cross-ratios C_j satisfy two algebraic equations, which can be determined by solving the equations for X^2 . One finds

$$\begin{aligned} C_1 C_5 - C_4 &= 0, \\ (3C_4 - C_1)^2 - C_4(C_1 + 1)^2 &= 0. \end{aligned} \quad (3.36)$$

Using (3.29) and (3.17), the cross-ratios are identified with quotients of Siegel theta functions (see Appendix B.5), and the above equations take the form

$$\begin{aligned} 0 &= \Theta_3^4 - \Theta_4^4, \\ 0 &= \Theta_1^2 \Theta_2^2 \Theta_8^4 \Theta_3^4 - \Theta_2^4 \Theta_8^2 \Theta_{10}^2 \Theta_3^4 + 8 \Theta_1^2 \Theta_2^2 \Theta_4^2 \Theta_8^2 \Theta_{10}^2 \Theta_3^2 + \Theta_1^2 \Theta_2^2 \Theta_4^4 \Theta_{10}^4 - 9 \Theta_1^4 \Theta_4^4 \Theta_8^2 \Theta_{10}^2. \end{aligned} \quad (3.37)$$

The two systems of equations above are equivalent given that none of the λ_j vanish or are infinite, which is an assumption of Picard's lemma (3.17). We can use the second relation of (3.35) to solve for u ,

$$u^3 = \frac{\sqrt{27}}{2} \frac{(3C_4 + 1)^3}{\sqrt{C_4}(C_4 - 1)}, \quad (3.38)$$

and in terms of theta constants this gives

$$u^3 = \frac{\sqrt{27}}{2} \frac{(3\Theta_1^2 \Theta_8^2 + \Theta_2^2 \Theta_{10}^2)^3}{\Theta_1 \Theta_2^3 \Theta_8 \Theta_{10}^3 (\Theta_1^2 \Theta_8^2 - \Theta_2^2 \Theta_{10}^2)}. \quad (3.39)$$

This can be viewed as a generalisation of the rank 1 result (1.40), in the sense that we can write the parameter u as a rational function of theta series. It follows naively that u transforms as a weight 0 function under a subgroup of $\mathrm{Sp}(4, \mathbb{Z})$.

3.3.2 A modular expression for u

The solutions to the algebraic relations (3.37) are not unique due to the periodicity in the τ_{IJ} . The first equation implies $\tau_{11} - \tau_{22} = 2k$ with $k \in \mathbb{Z}$, but we know from (3.12) that $k = 0$. From (3.13) we can make a power series expansion for τ_{12} in terms of $p = e^{2\pi i \tau_{11}}$. One finds

$$\tau_{12} = -\frac{1}{2}\tau_{11} - \frac{1}{2\pi i} \log(8) + \frac{1}{2\pi i} \frac{27}{4} h(p), \quad (3.40)$$

with

$$h(p) = p^{\frac{1}{2}} - \frac{63}{16} p + \frac{1447}{64} p^{\frac{3}{2}} - \frac{307679}{2048} p^2 + \mathcal{O}(p^{\frac{5}{2}}), \quad (3.41)$$

by satisfying the second relation in (3.37) order by order. Substitution of (3.40) in (3.38) gives the following p -expansion for u ,

$$u = \frac{1}{2} p^{-\frac{1}{6}} + \frac{43}{8} p^{\frac{1}{3}} - \frac{2923}{128} p^{\frac{5}{6}} + \frac{1713}{16} p^{\frac{4}{3}} + \mathcal{O}(p^{\frac{11}{6}}). \quad (3.42)$$

One can verify agreement with the Picard-Fuchs approach by substituting this expansion in Eq. (3.12). As this series is only an expansion for small p , it is not very elucidating. To arrive at a closed expression, we aim to express u as a function of a ‘‘coupling constant’’ which transforms well under the duality transformations. This is not the case for τ_{11} .

However when $\tau_{11} = \tau_{22}$, the inversion $\mathcal{S} = \begin{pmatrix} 0 & -1 \\ 1 & 0 \end{pmatrix} \in \mathrm{Sp}(4, \mathbb{Z})$ acts naturally on the linear combinations $\tau_{\pm} = \tau_{11} \pm \tau_{12}$, which are in one-to-one correspondence with τ_{11} and τ_{12} . From (B.39), we deduce for the action of \mathcal{S} on τ_{\pm}

$$\mathcal{S} : \tau_{11} \pm \tau_{12} \mapsto -\frac{1}{\tau_{11} \pm \tau_{12}}. \quad (3.43)$$

That is to say, it reduces to the ordinary S -transformation $\tau_{\pm} \mapsto -1/\tau_{\pm}$. Moreover, $\tau_{\pm} \in \mathbb{H}$ for both \pm . To see this note that since $\mathrm{Im}(\Omega)$ is positive definite, we have that $y_{11} > 0$ and $y_{11}y_{22} - y_{12}^2 > 0$, where $y_{IJ} = \mathrm{Im}(\tau_{IJ})$. Whenever $y_{11} = y_{22}$, the latter inequality implies that $y_{11}^2 > y_{12}^2$. Since $y_{11} > 0$, it implies $y_{11} > y_{12}$ and $y_{11} > -y_{12}$ simultaneously. From this we learn that $y_{11} - y_{12}$ and $y_{11} + y_{12}$ are both positive and therefore $\tau_{\pm} := \tau_{11} \pm \tau_{12} \in \mathbb{H}$.

We will proceed by considering $\tau_- =: \tau$, leaving the discussion on τ_+ for Section 3.3.3. To determine u as function of τ , one can first find the series expansion for τ in terms of p , invert and substitute $p(\tau)$ in (3.42). Alternatively, one can revert to the

Picard-Fuchs solution, by inverting the series (3.12) for $v = 0$,

$$q = e^{2\pi i(\tau_{11}(u) - \tau_{12}(u))} = U^3 + 45U^4 + 1512U^5 + 45672U^6 + \dots, \quad U = \frac{1}{4u^3}. \quad (3.44)$$

Either method gives us the following series for u ,

$$\sqrt[3]{4}u = q^{-\frac{1}{9}} + 5q^{\frac{2}{9}} - 7q^{\frac{5}{9}} + 3q^{\frac{8}{9}} + 15q^{\frac{11}{9}} - 32q^{\frac{14}{9}} + \mathcal{O}(q^{\frac{17}{9}}). \quad (3.45)$$

This expansion is also known as the McKay-Thompson series of class 9B for the Monster group [103, 86, 87, 36]. Thus similarly to the u for the modular rank 1 theories, we find a McKay-Thompson series. We then have

$$u = u_-(\tau) = \sqrt[3]{\frac{27}{4}} \frac{b_{3,0}\left(\frac{\tau}{3}\right)}{b_{3,1}\left(\frac{\tau}{3}\right)}, \quad (3.46)$$

where $b_{3,j}$ are theta series for the A_2 root lattice,

$$b_{3,j}(\tau) = \sum_{k_1, k_2 \in \mathbb{Z} + \frac{j}{3}} q^{k_1^2 + k_2^2 + k_1 k_2}, \quad j \in \{-1, 0, 1\}. \quad (3.47)$$

The theta series $b_{3,j}$ transform under the generators of $\text{SL}(2, \mathbb{Z})$ as ($\alpha = e^{2\pi i/3}$)

$$\begin{aligned} S: \quad b_{3,j}\left(-\frac{1}{\tau}\right) &= -\frac{i\tau}{\sqrt{3}} \sum_{l \pmod{3}} \alpha^{2jl} b_{3,l}(\tau), \\ T: \quad b_{3,j}(\tau + 1) &= \alpha^{j^2} b_{3,j}(\tau). \end{aligned} \quad (3.48)$$

The solution u_- can also be expressed in terms of the Dedekind η -function (B.5) as

$$u_-(\tau) = \sqrt[3]{\frac{27}{4}} \left(1 + \frac{1}{3} \frac{\eta\left(\frac{\tau}{9}\right)^3}{\eta(\tau)^3} \right). \quad (3.49)$$

Using Theorem 1 of Appendix B.1, one shows that $u_-(9\tau)$ is a modular function for the congruence subgroup $\Gamma_0(9)$. This implies that u is a modular function for $\Gamma^0(9)$, which is generated by the matrices T^9 , STS and $(T^3S)T(T^3S)^{-1}$.

Let us analyse the strong coupling singularities $u^3 = \frac{27}{4}$ for $v = 0$ in terms of the variable τ . We will demonstrate that these correspond to $\tau \rightarrow 0, 3$ and -3 . Using (3.48), one finds that the expansion around 0 takes the form

$$\begin{aligned} \sqrt[3]{\frac{4}{27}} u_{-,D}(\tau_D) &= \frac{b_{3,0}(3\tau_D) + 2b_{3,1}(3\tau_D)}{b_{3,0}(3\tau_D) - b_{3,1}(3\tau_D)} \\ &= 1 + 9q_D + 27q_D^2 + 81q_D^3 + 198q_D^4 + \mathcal{O}(q_D^5), \end{aligned} \quad (3.50)$$

with $\tau_D = -1/\tau$, $q_D = e^{2\pi i \tau_D}$ and $u_{-,D}(\tau_D) := u_-(-1/\tau_D)$. In the same notation we can invert the series to find

$$q_D = \chi - 3\chi^2 + 9\chi^3 - 22\chi^4 + 21\chi^5 + 207\chi^6 + \mathcal{O}(\chi^7), \quad (3.51)$$

where $\chi := (\sqrt[3]{4/27}u - 1)/9$. It follows that $q_D \rightarrow 0$ for $\sqrt[3]{4/27}u \rightarrow 1$ or $\chi \rightarrow 0$. This can be directly confirmed by analytically continuing the Picard-Fuchs expansion around $u = \sqrt[3]{27/4}$.

The expansion around ± 3 can then be obtained from the one around 0 by shifting the argument $\tau_{D,\pm} = -\frac{1}{\tau} \pm 3$, and one finds using the T -transformation (3.48) that

$$u_{-,D}(\tau_{D,\pm}) = \alpha^{\mp 1} \sqrt[3]{\frac{27}{4}} \frac{b_{3,0}(3\tau_D) + 2b_{3,1}(3\tau_D)}{b_{3,0}(3\tau_D) - b_{3,1}(3\tau_D)} \quad (3.52)$$

The expansions around the points 3 and -3 differ from the one around 0 only by the phases $\alpha^{-1} = \alpha^2$ and α . Together with (3.50), this proves that indeed $\tau \rightarrow \{0, -3, 3\}$ corresponds to the three singularities $\underline{u} \rightarrow \{1, \alpha, \alpha^2\}$. Due to the T^9 -invariance of the solution (3.46), there is an ambiguity in identifying the τ -parameter with $\tau + 9\mathbb{Z}$. These \mathbb{Z}_2 points are studied in detail in [94, 104]. They correspond to the 3 vacua of the $\mathcal{N} = 1$ theory after deforming the $\mathcal{N} = 2$ theory by relevant or marginal terms.

The modular analysis is completely analogous to the $SU(2)$ theories: The cusps of $\Gamma^0(9)$ are $\{0, -3, 3, i\infty\}$, which is exactly where u assumes the \mathbb{Z}_2 vacua and the semi-classical limit. The fundamental domain of $\Gamma^0(9)$ is given in Figure 3.2 and is the union of 12 images of the $SL(2, \mathbb{Z})$ key-hole fundamental domain \mathcal{F} ,

$$\Gamma^0(9) \backslash \mathbb{H} = \bigcup_{\ell=-4}^4 T^\ell \mathcal{F} \cup S\mathcal{F} \cup T^3 S\mathcal{F} \cup T^{-3} S\mathcal{F}. \quad (3.53)$$

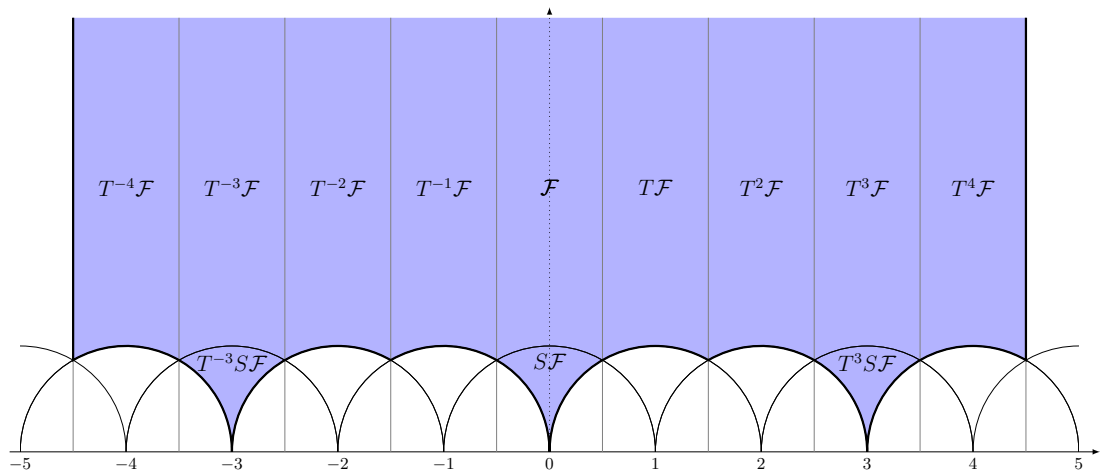

Fig. 3.2 Fundamental domain $\Gamma^0(9) \backslash \mathbb{H}$ of the congruence subgroup $\Gamma^0(9)$. It consists of 12 images of the key-hole fundamental domain \mathcal{F} .

Using (3.49), we can find the exact coupling at the origin of the moduli space. We have that $u(\tau_0) = 0$ for the $\Gamma^0(9)$ orbit of

$$\tau_0 = \sqrt{3}\omega = \frac{3}{2} + \frac{\sqrt{3}}{2}i, \quad (3.54)$$

with $\omega = e^{\pi i/6}$. The point τ_0 lies on the boundary of the fundamental domain, on the point where the boundary arcs from different cusps meet. The elements $(STS)^k \in \Gamma^0(9)$ map $\tau_0 \mapsto \tau_0 - 3k$ for integer k , which identifies the ‘‘corners’’ in Figure 3.2. This is compatible with the global \mathbb{Z}_3 symmetry, which also acts by T^{-3} and leaves the origin invariant. It is in complete analogy to the SU(2) picture, see Section 1.1.1: We find the nice picture that the cusps of $\Gamma^0(9)\backslash\mathbb{H}$ are in one-to-one correspondence with the singularities $u^3 = \frac{27}{4}$ and $u = \infty$ and the origin is the symmetric point where the boundary arcs meet.

We will derive the modular expression for u from the SW geometry in Section 3.5. Section 3.6.2 will discuss how the action of the SU(3) monodromies reduce to the generators of $\Gamma^0(9)$ for the action on τ_- .

The connection between elliptic curves and theta constants furthermore allows to express the periods $\frac{\partial a_I}{\partial u_J}$ as modular forms. Indeed, the period matrix $\frac{\partial a_I}{\partial u_J}$ can be written as a combination of even, odd and differentiated theta constants [105]. By substituting the solution for u and v into the asymptotic expansion of the periods, we can confirm this for some cases. Recall that in the SU(2) theory, a is a quasi-modular form and $\frac{da}{du}$ is a modular form of $\Gamma^0(4)$ with non-trivial multipliers, both of weight 1 [16]. For rank 2, one finds that on $v = 0$ and with $\tau = \tau_-$,

$$\frac{\partial a_1}{\partial v}(\tau) = -\frac{\partial a_2}{\partial v}(\tau) = \frac{1}{3\sqrt[3]{2}}b_{3,1}\left(\frac{\tau}{3}\right) = \frac{1}{\sqrt[3]{2}}\frac{\eta(\tau)^3}{\eta(\frac{\tau}{3})}. \quad (3.55)$$

This is a modular form of weight 1 on $\Gamma^0(9)$, which of course is the same modular group as for u .

3.3.3 The other solution for u

While we chose in the above the modular parameter $\tau_- = \tau_{11} - \tau_{12}$, Equation (3.43) shows that we could equally well consider $\tau_+ = \tau_{11} + \tau_{12}$. We will consider the variable $\tau := \tau_+$ in this subsection. We can determine the first terms in the q -expansion of u , which results in

$$u = u_+(\tau) = \frac{1}{4}\left(q^{-1/3} + 104q^{2/3} - 7396q^{5/3} + \mathcal{O}(q^{8/3})\right). \quad (3.56)$$

This series can be recognised as the q -expansion of

$$u_+(\tau) = \sqrt[3]{\frac{27}{2}} \frac{E_4(\tau)^{1/2}}{(E_4(\tau)^{3/2} - E_6(\tau))^{1/3}}, \quad (3.57)$$

where E_4 and E_6 are the Eisenstein series (B.7). We will derive this explicitly in Section 3.5. We can recognise this function as the order parameter of SU(2) theory with one massless fundamental hypermultiplet [20]. Exactly as we saw in Sec. 2.2 for the case of two fundamental hypermultiplets, the fractional powers in (3.57), makes the modularity of u_+ more subtle and it is not a modular function for $\text{SL}(2, \mathbb{Z})$. In fact, $E_4^{1/2}$ and u_+ are not invariant under *any* subgroup of $\text{SL}(2, \mathbb{Z})$. One way to see this is that E_4 has a simple zero for $\tau = \alpha$, such that the square root introduces a branch point.

It is known since the time of Fricke and Klein that similar fractional powers of modular forms as in u_+ do appear in the context of Picard-Fuchs equations and hypergeometric functions [106, 107].

As mentioned before, the fractional powers in (3.57) are incompatible with any subgroup of $\text{SL}(2, \mathbb{Z})$. Nevertheless, if we choose a basepoint, we can show that u_+ is invariant under transformations of τ , which combine to a closed trajectory with starting and endpoint equal to the base point. We choose the base point τ_b with $\text{Re}(\tau_b) = 0$ and $\text{Im}(\tau_b) \gg 1$. First, using the modular transformation of E_4 and E_6 , we find for the expansion of τ near 0,

$$\tau \rightarrow 0 : \quad u_+(\tau) = u_{+,D}(-1/\tau), \quad (3.58)$$

with

$$\begin{aligned} u_{+,D}(\tau_D) &= \sqrt[3]{\frac{27}{2}} \frac{E_4(\tau_D)^{1/2}}{(E_4(\tau_D)^{3/2} + E_6(\tau_D))^{1/3}} \\ &= \sqrt[3]{\frac{27}{4}} \left(1 + 144 q_D - 3456 q_D^2 + 596160 q_D^3 + \dots \right). \end{aligned} \quad (3.59)$$

From Eq. (3.56) we see that u_+ is invariant under $\tau \mapsto \tau + 3$ at weak coupling, $\text{Im}(\tau) \gg 1$. Let us introduce T_w for the translation at weak coupling. Moreover at strong coupling, $0 < \text{Im}(\tau) \ll 1$, u_+ is invariant under $\tau_D = -1/\tau \mapsto \tau_D + 1$. Let us introduce T_s for the translation at strong coupling. We can get the monodromies around the other cusps, $\tau = \pm 1$ from conjugation with T_w . We then find that u_+ is left invariant by

$$T_w^{3n}, \quad (T_w^\ell S) T_s (T_w^\ell S)^{-1}, \quad \ell, n \in \mathbb{Z}, \quad (3.60)$$

where S is the usual inversion $\tau \mapsto -1/\tau$, mapping τ from weak to strong coupling. These transformations are sketched in Figure 3.3 for $n = 1$ and $\ell = 0, \pm 1$.

We denote the invariance group of u_+ by Γ_{u_+} . It is generated by the elements in (3.60) with $n = 1$, and $\ell = 0, 1$. From the invariance under (3.60), one derives that a

fundamental domain is given by

$$\Gamma_{u_+} \backslash \mathbb{H} = \bigcup_{\ell=-1}^1 T^\ell \mathcal{F} \cup T^\ell S \mathcal{F}. \quad (3.61)$$

It consists of six copies of \mathcal{F} . This fundamental domain is the grey area in Figure 3.3. The domain is clearly topologically equivalent to the fundamental domain in Figure 3.2. The expansions of u_+ and $u_{+,D}$ demonstrate that $u_+(i\infty) = \infty$, $u_+(0) = \sqrt[3]{\frac{27}{4}}$ and

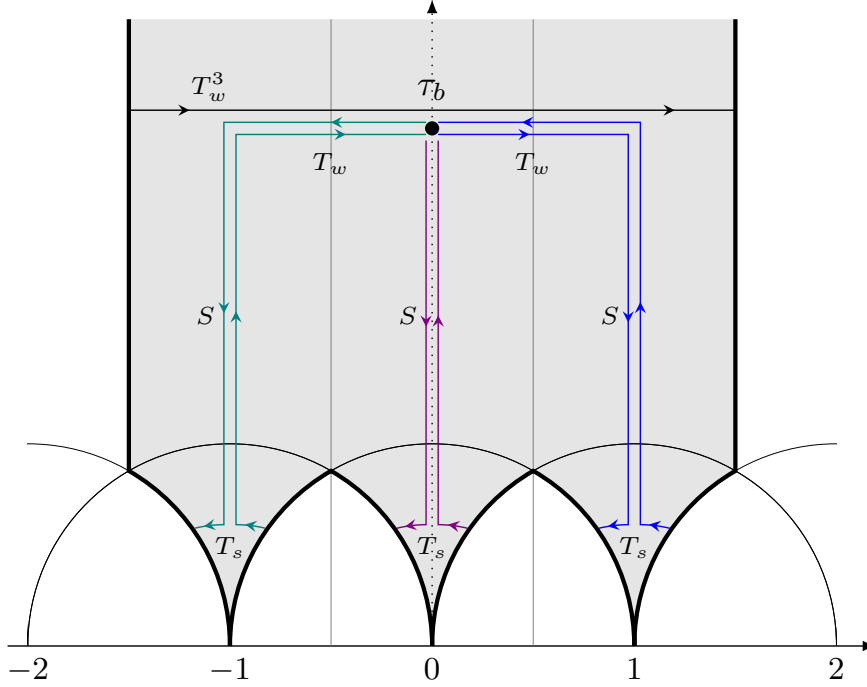

Fig. 3.3 Fundamental domain for u_+ . The vertical lines at $\tau = \pm 3/2$ are identified, as well as each pair of the two arcs meeting at a cusp $-1, 0$ or 1 . The point τ_b is the base point for the monodromies, which are compositions of T_w , T_s and S . T_w is a shift $\tau \mapsto \tau + 1$ at weak coupling, T_s circles around a strong coupling cusp, and S maps τ from weak to strong coupling.

$u_+(\pm 1) = \alpha^\mp \sqrt[3]{\frac{27}{4}}$. We will derive u_+ from the SW geometry in Section 3.5, and the transformations (3.60) in Section 3.6.2 from the SU(3) monodromies around the strong coupling cusps.

Because u_+ is not a weakly holomorphic modular form, but involves fractional powers of modular forms, it is problematic to identify the transformations (3.60) with elements of $\text{SL}(2, \mathbb{Z})$. One way to see that this identification is problematic is that the composition of S , T_w and T_s does not satisfy the relation $(ST)^3 = -\mathbb{1}$, if we identify $T_w = T_s = T = \begin{pmatrix} 1 & 1 \\ 0 & 1 \end{pmatrix}$. To further study this aspect, let us list the $\text{SL}(2, \mathbb{Z})$ matrices

corresponding to (3.60),

$$\begin{aligned}
T^3 &= \begin{pmatrix} 1 & 3 \\ 0 & 1 \end{pmatrix}, \\
STS^{-1} &= \begin{pmatrix} 1 & 0 \\ -1 & 1 \end{pmatrix}, \\
(TS)T(TS)^{-1} &= \begin{pmatrix} 0 & 1 \\ -1 & 2 \end{pmatrix}, \\
(T^{-1}S)T(T^{-1}S)^{-1} &= \begin{pmatrix} 2 & 1 \\ -1 & 0 \end{pmatrix}.
\end{aligned} \tag{3.62}$$

These matrices fix each of the cusps $\{\infty, 0, 1, -1\}$. On the other hand, u_+ is not invariant under the modular action of the matrices on τ , $\tau \mapsto (a\tau + b)/(c\tau + d)$ except for T^{3n} . For example, STS^{-1} would map $\tau = i\infty$ to -1 . The values of u_+ are however different for these two arguments: $u_+(i\infty) = \infty$ and $u_+(-1) = \alpha\sqrt[3]{\frac{27}{4}}$. Furthermore, the matrices (3.62) generate the full modular group $\mathrm{SL}(2, \mathbb{Z})$, analogous to the case of equal mass $N_f = 2$ studied in Sec. 2.2.

The origin $u_+(\tau_0) = 0$ of the moduli space is again given by the points where the boundary arcs meet: At $\tau_0 = \alpha$ we have that E_4 vanishes but E_6 does not. From (3.57) it is then clear that $\tau_0 + \mathbb{Z}$ are indeed the zeros of u_+ . This is also compatible with the \mathbb{Z}_3 global symmetry, which according to (3.56) acts as T^{-1} and leaves the origin invariant.

Using the parameter $\tau = \tau_+$ we now find

$$\frac{\partial a_1}{\partial u}(\tau) = \frac{\partial a_2}{\partial u}(\tau) = \frac{1}{2^{5/6} \cdot \sqrt{3}} \left(E_4(\tau)^{3/2} - E_6(\tau) \right)^{1/6}. \tag{3.63}$$

3.4 Locus $\mathcal{E}_v: u = 0$

We will now consider the second elliptic locus, namely where $u = 0$. By doing a similar analysis as in Section 3.3 but now for large v , we find that the correct matching between the cross-ratios and the Rosenhain invariants for this limit is

$$\lambda_1 = C_5, \quad \lambda_2 = C_4, \quad \lambda_3 = C_1. \tag{3.64}$$

Note that the only difference from before is that the roles of λ_2 and λ_3 have been interchanged. One could perform a change of symplectic basis to have the same matching as (3.29). This can be done by acting on the periods with the matrix $\mathcal{T}_\theta = \begin{pmatrix} 1 & \theta \\ 0 & 1 \end{pmatrix} \in \mathrm{Sp}(4, \mathbb{Z})$ with $\theta = \begin{pmatrix} -1 & 2 \\ 2 & -4 \end{pmatrix}$.¹ This changes the ω_1, ω_2 prefactors of $a_{D,1}$ in

¹Note that there is an ambiguity in the choice of \mathcal{T}_θ . The λ_j are invariant under a subgroup of $\mathrm{Sp}(4, \mathbb{Z})$. Multiplying \mathcal{T}_θ with an element of this group thus gives the same result.

(C.16). This would however also change the Rosenhain form, and we therefore prefer to continue with the identification in (3.64).

We will proceed by deriving the relations satisfied by the couplings τ_{IJ} on the locus $u = 0$.

3.4.1 Algebraic relations

To determine the algebraic relations among the theta constants, we assume that v is real, large and positive. In this limit we find that $s_{+\pm} = \sqrt[3]{v \pm 1}$ and $s_{-\pm} = 0$. The cross-ratios (3.30) simplify to

$$\begin{aligned} C_1 &= -\alpha^2 \frac{s_{++} - \alpha s_{+-}}{s_{++} - \alpha^2 s_{+-}}, \\ C_4 &= -\frac{\alpha^2 (s_{++} - \alpha s_{+-})^2}{3 s_{++} s_{+-}}, \\ C_5 &= +\frac{1 (s_{++} - \alpha s_{+-}) (s_{++} - \alpha^2 s_{+-})}{3 s_{++} s_{+-}}. \end{aligned} \quad (3.65)$$

From this we find two algebraic relations between the cross-ratios, namely

$$\begin{aligned} C_1 C_5 - C_4 &= 0, \\ C_5^2 + C_4^2 - C_5 C_4 - C_4 &= 0. \end{aligned} \quad (3.66)$$

Writing these in terms of the theta constants, we have

$$\begin{aligned} 0 &= \Theta_1^4 - \Theta_2^4, \\ 0 &= \Theta_2^4 \Theta_3^2 \Theta_8^4 + \Theta_1^4 \Theta_3^2 \Theta_{10}^4 - \Theta_1^2 \Theta_2^2 \Theta_3^2 \Theta_8^2 \Theta_{10}^2 - \Theta_2^4 \Theta_4^2 \Theta_8^2 \Theta_{10}^2. \end{aligned} \quad (3.67)$$

3.4.2 Modular expression for v

Our next aim is to determine a modular expression for v on this elliptic locus. The first relation in (3.67) implies $\tau_{11} = \tau_{22} + 2\mathbb{Z} + 1$, while the second one implies $\tau_{12} = \pm \frac{1}{2} \tau_{11} + \mathbb{Z}$. We claim that these are all the solutions. As in the case $v = 0$, the PF solution (3.15) fixes these relations,

$$\tau_{11} = \tau_{22} + 1, \quad \tau_{12} = -\frac{\tau_{11}}{2} + 1. \quad (3.68)$$

In contrast to the locus \mathcal{E}_u , these linear relations between the τ_{11} , τ_{22} and τ_{12} are exact on \mathcal{E}_v . Using the first equation in (3.65), we can solve for v ,

$$v = -\frac{i}{\sqrt{27}} \frac{(C_1 - 2)(C_1 + 1)(2C_1 - 1)}{C_1(C_1 - 1)}. \quad (3.69)$$

This can again be written as a rational function of Siegel theta functions,

$$v = -\frac{i}{\sqrt{27}} \frac{(\Theta_8^2 - 2\Theta_{10}^2)(\Theta_8^2 + \Theta_{10}^2)(2\Theta_8^2 - \Theta_{10}^2)}{\Theta_8^2 \Theta_{10}^2 (\Theta_8^2 - \Theta_{10}^2)}. \quad (3.70)$$

As a function of $\tau_- = \tau_{11} - \tau_{12}$, one finds ($q_- = e^{2\pi i \tau_-}$)

$$v = \frac{i}{2\sqrt{27}} \left(\alpha q_-^{-\frac{1}{6}} - 33 \alpha^2 q_-^{\frac{1}{6}} - 153 q_-^{\frac{1}{2}} - 713 \alpha q_-^{\frac{5}{6}} + \mathcal{O}(q_-^{\frac{7}{6}}) \right). \quad (3.71)$$

The expansion in terms of $\tau_+ = \tau_{11} + \tau_{12}$ is very similar. One can recognise these series as

$$\begin{aligned} v &= \frac{i}{2\sqrt{27}} m\left(\frac{\tau_+}{2}\right), \\ v &= \frac{i}{2\sqrt{27}} m\left(\frac{\tau_-}{6} + \frac{2}{3}\right), \end{aligned} \quad (3.72)$$

where

$$\begin{aligned} m(\tau) &= \left(\frac{\eta(2\tau)}{\eta(6\tau)} \right)^6 - 27 \left(\frac{\eta(6\tau)}{\eta(2\tau)} \right)^6 \\ &= q^{-1} - 33q - 153q^3 - 713q^5 - 2550q^7 - 7479q^9 + \mathcal{O}(q^{11}). \end{aligned} \quad (3.73)$$

The function m is known in the literature as the completely replicable function of class 6a [86, 87, 36]. The perturbative expansion (3.71) can be verified from the Picard-Fuchs solution by starting from Eq. (3.15) and setting $u = 0$. Then, expand $q = e^{2\pi i(\tau_{11}(v) - \tau_{12}(v))}$ as a series in v and invert it to find (3.71).

3.4.3 The \mathbb{Z}_3 vacua

Let us study the solution (3.72) near the strong coupling vacua. To this end, we eliminate the phases in (3.71) by substitution of $\tau := \tau_- + 1$ in (3.72). In the new variable τ , the solution reads

$$v = -\frac{i}{2\sqrt{27}} m\left(\frac{\tau}{6}\right). \quad (3.74)$$

It can be shown that the values of τ at the Argyres-Douglas (AD) vacua $v_{\text{AD},1} = 1$ and $v_{\text{AD},2} = -1$ are ($\omega = e^{\pi i/6}$)

$$\begin{aligned} \tau_{\text{AD},1} &= -\frac{3}{2} + \frac{\sqrt{3}i}{2} = \sqrt{3}\omega^5, \\ \tau_{\text{AD},2} &= +\frac{3}{2} + \frac{\sqrt{3}i}{2} = \sqrt{3}\omega, \end{aligned} \quad (3.75)$$

and the origin $(u, v) = (0, 0)$ is located at $\tau_0 = \sqrt{3}i$. Note that these values lie in the interior of the upper half-plane, rather than at the boundary.

The modular group of v is closely related to the duality group of the SU(3) theory on this locus. It can be shown that v is a modular form for the principal congruence

subgroup $\Gamma(6)$. However, the fundamental domain of this group has twelve cusps, and v diverges at all of them. This suggests that we found strongly coupled vacua in the region of the moduli space where v is large. But from the discriminant $\Delta_\Lambda|_{\mathcal{E}_v} = v^2 - 1$ we expect the only singularities to be at $v \in \{1, -1, \infty\}$. Since the singularities at $v = \pm 1$ correspond to AD points, we further might expect them to correspond to elliptic points of the duality group, following the analysis of the $SU(2)$ theories.

To resolve this problem, let us study the function m in more detail. It is a linear combination of eta quotients, whose modular properties have been studied extensively [108, 109]. Applying Theorem 1 in Appendix A, one finds that m is a modular function for the Hecke congruence subgroup $\Gamma_0(12)$. In addition, it satisfies the following non- $SL(2, \mathbb{Z})$ transformations

$$m\left(\tau - \frac{1}{2}\right) = -m(\tau), \quad (3.76a)$$

$$m\left(-\frac{1}{12\tau}\right) = -m(\tau). \quad (3.76b)$$

The transformation (3.76b) is also known as a *Fricke involution*. Translating both equations to the argument of v , we find that v picks up a minus sign under both T^{-3} and $F = \begin{pmatrix} 0 & -3 \\ 1 & 0 \end{pmatrix}$. Taking products, we find that v is properly invariant under $FT^{-3} = \begin{pmatrix} 0 & -3 \\ 1 & -3 \end{pmatrix}$ and T^{-6} . Let us normalise the former to $X = \frac{1}{\sqrt{3}} \begin{pmatrix} 0 & -3 \\ 1 & -3 \end{pmatrix}$, and denote the subgroup of $PSL(2, \mathbb{R})$ generated by these two elements as

$$\Gamma_v = \langle X, T^{-6} \rangle. \quad (3.77)$$

This group is a proper subgroup of the modular group $\Gamma^0(6|2) + 3$ of Atkin-Lehner type, in the notation of [36]. This Atkin-Lehner group extends the ordinary congruence subgroup $\Gamma^0(\frac{6}{2})$ by elements in $PSL(2, \mathbb{R})$. See Appendix A for the precise definition. If we allow for a non-trivial multiplier system, the modular group associated with m is $\Gamma^0(6|2) + 3$ [36]. The latter contains for example T^{-3} , under which we have shown that v is anti-invariant. We can write a similar set of matrices as (3.62),

$$M_1 = \begin{pmatrix} -3 & -3 \\ 1 & 0 \end{pmatrix}, \quad M_2 = \begin{pmatrix} 0 & 3 \\ -1 & 3 \end{pmatrix}, \quad M_\infty = \begin{pmatrix} 1 & -6 \\ 0 & 1 \end{pmatrix} = T^{-6}, \quad (3.78)$$

under which $v \sim m(\tau/6)$ is invariant. If we consider their normalisation to unit determinant, $\Pi(M_j) := |\det(M_j)|^{-1/2} M_j$, they lie in the group Γ_v (3.77), and furthermore satisfy

$$\Pi(M_1)\Pi(M_2) = M_\infty. \quad (3.79)$$

We will show in Section 3.6.2 that these generators match with the monodromies.

A fundamental domain for Γ_v can be drawn using the algorithm given in [36], and it is shown in Figure 3.4. The element T^6 contains the domain to $|\operatorname{Re} \tau| < 3$. X identifies the interior of the circle with radius $\sqrt{3}$ centered at 0, with a region inside the blue

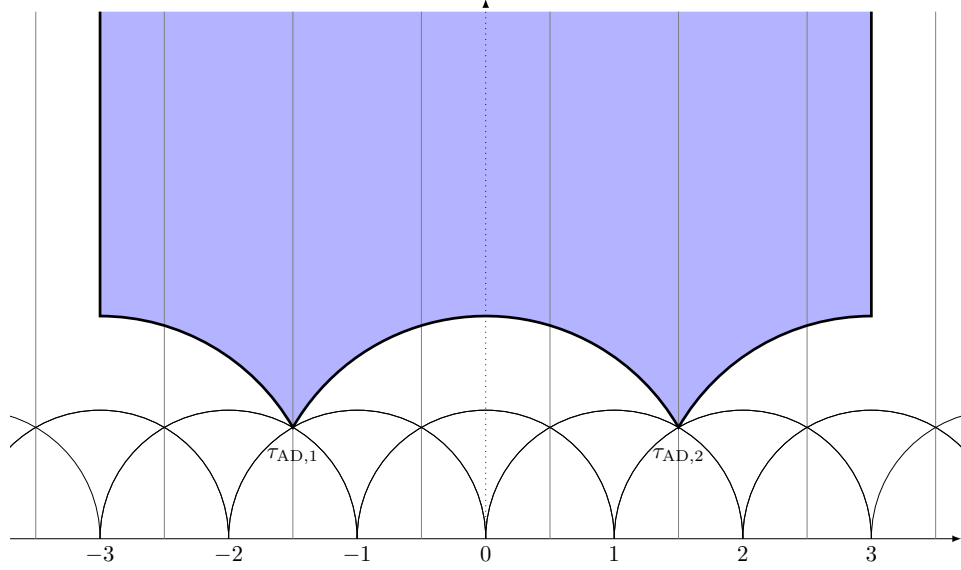

Fig. 3.4 Fundamental domain $\Gamma_v \backslash \mathbb{H}$ for the group Γ_v . The values of the special points are: $\tau_{AD,1} = \sqrt{3}\omega^5$ and $\tau_{AD,2} = \sqrt{3}\omega$, with $\omega = e^{\pi i/6}$.

domain in Figure 3.4. Similarly, the interior of the circles centered at ± 3 is identified with a region of the blue domain. We conclude,

$$\Gamma_v \backslash \mathbb{H} = \{z \in \mathbb{H} \mid |\operatorname{Re} z| < 3\} \setminus \bigcup_{\ell=-1}^1 \overline{D}_{\sqrt{3}}(3\ell). \quad (3.80)$$

where $\overline{D}_r(c)$ is the closed disc of radius r and center c .

The Argyres-Douglas vacua $v = 1$ and $v = -1$ correspond to the special points $\tau_{AD,j}$ (3.75). They are stabilised by M_1 and M_2 , respectively. This makes the AD vacua elliptic points of Γ_v . They are in fact expected to *not* get mapped to cusps of v , since their coupling matrix (3.105) lies inside the Siegel upper half-space \mathbb{H}_2 . As we saw in Chapter 2 this is a familiar property of superconformal points [9, 110, 2]. It is different from the \mathbb{Z}_2 points where the coupling matrices (3.104) are located on the boundary $\partial\mathbb{H}_2$ and therefore mapped to the real line $\partial\mathbb{H}_1$. The origin $\tau_0 = \sqrt{3}i$ is mapped under FT^{-3} to $\tau_0 - 3$, which is identified with τ_0 since $v = 0$ is a fixed point under $T^{-3} : v \mapsto -v$. The anti-invariance under T^{-3} is in fact directly derived from the \mathbb{Z}_2 symmetry $\rho : v \mapsto e^{\pi i}v$ computed in (3.103). The large v monodromy ρ^2 acts on τ as T^{-6} , under which v is invariant. The origin of the Fricke involution can therefore be understood from the global structure on the $u = 0$ plane.

Similarly to Section 3.3.2, we can express the periods in terms of modular forms. We have in terms of $\tau = \tau_{11} - \tau_{12} + 1$,

$$\frac{\partial a_1}{\partial u}(\tau) = \frac{\partial a_2}{\partial u}(\tau) = \frac{\sqrt[3]{2}\omega}{\sqrt{3}} \eta\left(\frac{\tau}{3}\right) \eta(\tau). \quad (3.81)$$

The discussion is similar for the parameter $\tau_+ = \tau_{11} + \tau_{12}$. If we introduce here $\tau = \tau_+ - 1$, v equals $-\frac{i}{2\sqrt{27}} m(\tau/2)$, which is again invariant under $\Gamma(6)$. It is multiplied by a sign under T as well as under the Fricke involution $\tilde{F} = \begin{pmatrix} 0 & -1 \\ 3 & 0 \end{pmatrix}$. This means that it is invariant under T^2 together with the involution $\tilde{X} := \tilde{F}T^{-1} = \begin{pmatrix} 0 & -1 \\ 3 & -3 \end{pmatrix}$, which again generate an Atkin-Lehner type group. The fundamental domain of this group equals that in Figure 3.4, but with all points divided by 3.

3.5 Geometrical interpretation in terms of elliptic curves

It is natural to expect that the complexified couplings τ_{\pm} for both loci \mathcal{E}_u and \mathcal{E}_v have an interpretation as complex structures of elliptic curves. Moreover, these elliptic curves are expected to be related to the geometry of the genus two Seiberg-Witten curve (3.6). We will make these expectations precise in this section.

Recall that the moduli space \mathcal{M}_2 of genus two curves is complex three-dimensional. The moduli space \mathcal{M}_2 contains two-dimensional loci $\mathcal{L}_2 \subset \mathcal{M}_2$, for which the genus two curves can be mapped to genus one with a map of degree 2 [111]. The map can be lifted to a map of the Jacobians of the curves. The Jacobian of the genus two curve is a four-torus, while the Jacobian of a genus one curve is a two-torus. For the curves contained in \mathcal{L}_2 , there is a degree two map from the genus two Jacobian to the genus one Jacobian. The Jacobian of a curve in \mathcal{L}_2 factors, $T^4 \cong T^2 \times T^2$, which demonstrates that for a generic curve in \mathcal{L}_2 , there are two distinct maps $\varphi_j : \Sigma_2 \rightarrow \Sigma_{1,j}$, $j = 1, 2$ to two elliptic curves $\Sigma_{1,j}$. We will see in this section that these elliptic curves $\Sigma_{1,j}$ have precisely the complex structures τ_{\pm} introduced above.

The locus \mathcal{L}_2 can be characterised as the zero locus of a weight 30 polynomial in the genus two Igusa invariants J_2, J_4, J_6, J_{10} [112, Theorem 3]. Additionally, the SU(3) vacuum moduli space also corresponds to a two-dimensional locus \mathcal{U} in \mathcal{M}_2 . It is easy to show that \mathcal{U} and \mathcal{L}_2 intersect in three one-dimensional loci, where two are exactly given by \mathcal{E}_u and \mathcal{E}_v , while the third one is defined by

$$\begin{aligned} \mathcal{E}_3 : \quad & 784u^9 - 24u^6(297v^2 + 553) - 15u^3(729v^4 + 5454v^2 - 4775) \\ & + 8(27v^2 - 25)^3 = 0. \end{aligned} \tag{3.82}$$

This locus does not include any special points of the SU(3) theory, and we will not study it further.

The locus \mathcal{L}_2 can also be characterised in terms of Rosenhain invariants of the curve [112, Equation (18)]. By plugging in the cross-ratios we can check that the SU(3) Seiberg-Witten curve is not in \mathcal{L}_2 for generic u, v . For $v = 0$ we rediscover the first algebraic relation (3.36), while for $u = 0$ we find both relations (3.66). This arises from an additional symmetry of the $u = 0$ curve, which we will comment on below.

The curves described by the locus \mathcal{L}_2 can be written in the form [112]

$$Y^2 = X^6 - s_1 X^4 + s_2 X^2 - 1, \quad (3.83)$$

with s_1 and s_2 complex coordinates for \mathcal{L}_2 . This family of curves is left invariant by a non-trivial automorphism group, which contains the Klein four-group V_4 [113]. Namely, the curve (3.83) is left invariant by $(X, Y) \mapsto (-X, Y)$ and $(X, Y) \mapsto (X, -Y)$, which generate the dihedral group $D_4 \cong V_4 \cong \mathbb{Z}_2 \times \mathbb{Z}_2$. We interpret this group as the symmetry group of the BPS/anti-BPS spectrum, and more precisely the central charges of the W-bosons Z_j (3.2) and their charge conjugates. For $v = 0$, Eq. (3.11) shows that $a_1 = a_2 = a$, such that $Z_1 = Z_2 = a$, and $Z_3 = 2a$. One $\mathbb{Z}_2 \subset D_4$ corresponds to the charge conjugation symmetry, while the other \mathbb{Z}_2 corresponds to the $a_1 \leftrightarrow a_2$ symmetry on \mathcal{E}_u . Note that the automorphism group of a generic genus two curve is \mathbb{Z}_2 , which is consistent with the charge conjugation symmetry for arbitrary (u, v) .

For $v = 0$, the Seiberg-Witten curve $Y^2 = (X^3 - uX)^2 - 1$ is of the form (3.83), with $s_1 = 2u$ and $s_2 = u^2$. We can map this to an elliptic curve through the degree two map

$$(x, y) = (X^2, Y), \quad (3.84)$$

which maps the algebraic equation (3.83) to

$$y^2 = x(x - u)^2 - 1. \quad (3.85)$$

Using the methods of Chapter 2 we can thus determine u as

$$u(\tau) = \sqrt[3]{\frac{27}{2} \frac{\sqrt{E_4(\tau)}}{(E_4(\tau)^{3/2} - E_6(\tau))^{1/3}}} = \frac{1}{4} \left(q^{-1/3} + 104 q^{2/3} - 7396 q^{5/3} + \mathcal{O}(q^{8/3}) \right). \quad (3.86)$$

We immediately recognise this function as the function u_+ (3.56), which was obtained from the Picard-Fuchs solution for the modular parameter $\tau_+ = \tau_{11} + \tau_{12}$. The curve (3.85) is exactly the Seiberg-Witten curve for the $SU(2)$ theory with one massless hypermultiplet in the fundamental representation and scales related by $\Lambda_{SU(2)} = 2\Lambda_{SU(3)}$, Eq. (2.1).

The elliptic curve corresponding to the order parameter u_- is found in a similar way by first transforming $(X, Y) \mapsto (\frac{1}{X}, \frac{iY}{X^3})$ followed by the identification $(x, y) = (X^2, Y)$ as before. This results in the elliptic curve

$$y^2 = x(x^2 - u^2 x + 2u) - 1, \quad (3.87)$$

which gives the order parameter $u = u_-$ from Section 3.3.2 when applying the methods of Chapter 2.

A similar analysis can of course be made on the locus with $u = 0$. An interesting feature of this SW curve, $Y^2 = X^6 - 2vX^3 + v^2 - 1$, is that it has enhanced symmetry compared to the Klein four-group for (3.83). Since $v^2 - 1$ is the discriminant, we can divide and rescale X to find

$$Y^2 = X^6 - \frac{2v}{\sqrt{v^2 - 1}}X^3 + 1. \quad (3.88)$$

It is easy to show that any curve of the form $Y^2 = X^6 - aX^3 + 1$ is invariant under $(X, Y) \mapsto (\frac{1}{X}, \frac{Y}{X^3})$ and $(X, Y) \mapsto (\alpha X, -Y)$, where again $\alpha = e^{2\pi i/3}$. These order 2 and 6 elements generate the dihedral group D_{12} . Similarly to the enhanced automorphism group for \mathcal{E}_u , we interpret this group as a symmetry group of the BPS/anti-BPS spectrum. From Appendix C.3, we know that $a_2 = -\alpha a_1$ on \mathcal{E}_v . The central charges Z_j (3.2) of the W-bosons, together with their charge conjugates, span therefore a regular 6-gon, whose symmetry group is D_{12} .

Hyperelliptic curves $C \in \mathcal{L}_2$ with $\text{Aut}(C) \cong D_{12}$ satisfy an additional constraint, it is given by the zero locus of a weight 20 polynomial in the Igusa invariants [114, Eq. (24)]. Moreover, the elliptic subcovers of hyperelliptic curves with $\text{Aut}(C) \cong D_{12}$ are isogenous [112]. We can check explicitly that the $u = 0$ curve is of this form. This explains why the elliptic curves for the two complex structures produce a single modular function (3.72), rather than the two independent functions u_{\pm} for \mathcal{E}_u . On \mathcal{E}_u the first algebraic relation in (3.36) holds and places the curve in \mathcal{L}_2 . On \mathcal{E}_v both relations (3.66) hold, where the first one projects into \mathcal{L}_2 and the second one gives the augmented D_{12} symmetry. This is consistent with the argument of Section 3.3.2 that the maps φ_j should exist as long as $\text{Im}(\tau_{11}) = \text{Im}(\tau_{22})$, such that it is possible to define $\tau_{\pm} = \tau_{11} \pm \tau_{12} \in \mathbb{H}$. The first relations in both (3.36) and (3.66) are equivalent to this condition.

The expressions for the periods (3.55) and (3.63) on the locus \mathcal{E}_u can be partially understood in this setting as well, as periods of the elliptic subcovers. Note that the periods of the genus two curve are given by

$$\frac{\partial a_I}{\partial u_J} = \int_{\alpha_I} \omega_{J-1}, \quad I, J = 2, 3, \quad u_2 = u, \quad u_3 = v, \quad (3.89)$$

where ω_I are the holomorphic differentials [95]

$$\omega_1 = \frac{XdX}{Y}, \quad \omega_2 = \frac{dX}{Y}. \quad (3.90)$$

Under the mappings to the elliptic subcovers, given above, for the $v = 0$ curve these differentials are mapped to

$$\omega_1 \mapsto \frac{dx}{2y}, \quad \omega_2 \mapsto \frac{dx}{2\sqrt{xy}}, \quad (3.91)$$

for the τ_+ map and

$$\omega_1 \mapsto \frac{i dx}{2\sqrt{xy}}, \quad \omega_2 \mapsto \frac{i dx}{\sqrt{2y}}, \quad (3.92)$$

for the τ_- mapping. As discussed in Sec. 2.1.4, we use the Néron differential, $\frac{dx}{y}$, to calculate the periods of the elliptic curves through

$$\frac{da}{du} = \beta \int_{\gamma_1} \frac{dx}{y}, \quad (3.93)$$

for some proportionality constant β . This can be done using the formula, derived in Sec. 2.1.4,

$$\frac{da}{du} = \tilde{\beta} \sqrt{\frac{g_2 E_6}{g_3 E_4}}, \quad (3.94)$$

for some other constant $\tilde{\beta}$ which is related to the first one through the change of basis to the modular Weierstraß curve.

We thus see from the above that we should expect that applying this formula to the τ_+ curve we should find a period proportional to $\frac{\partial a_1}{\partial u}$, while for the τ_- we should instead expect to find a period proportional to $\frac{\partial a_1}{\partial v}$, which is exactly what we find, giving the formulas (3.55) for τ_- and (3.63) for τ_+ . This gives a partial understanding of the periods of the genus two curve in terms of the elliptic subcovers. However, it does not say anything about the remaining genus two period in either case, and it further does not seem to work on the locus with $u = 0$.

3.6 Monodromies

We study the weak and strong coupling monodromies in this section. In this way, we are able to derive the modular groups of the order parameters in Section 3.3, which parametrise the elliptic loci. As before, we are interested in studying the two patches of the moduli space where one of the parameters u and v is large compared to the other.

3.6.1 Weak coupling monodromies

The spontaneously broken global \mathbb{Z}_3 and \mathbb{Z}_2 symmetries are generated by $\sigma : u \mapsto \alpha u$ and $\rho : v \mapsto e^{\pi i} v$, respectively. Using the explicit Picard-Fuchs solutions (C.10) and (C.16), we can determine how these symmetries act on the periods in the weak coupling region of the Coulomb branch.

Weak coupling in locus \mathcal{E}_u

In the large u regime we are interested in the action of σ on the PF solutions in (C.10). We can readily determine that it acts on the periods as the matrix

$$\sigma_u = \alpha^2 \mathcal{P} \begin{pmatrix} 0 & 1 & 1 & -2 \\ 1 & 0 & -2 & 1 \\ 0 & 0 & 0 & 1 \\ 0 & 0 & 1 & 0 \end{pmatrix}, \quad (3.95)$$

where the subscript u indicates that the base point is at large u , and $\mathcal{P} = \begin{pmatrix} -1 & 0 \\ 0 & -1 \end{pmatrix}$ is the central element of $\mathrm{Sp}(4, \mathbb{Z})$. The matrix σ_u conjugates the semi-classical monodromies (3.10) to each other,

$$\begin{aligned} \sigma_u^{-1} \mathcal{M}^{(r_1)} \sigma_u &= \mathcal{M}^{(r_2)}, \\ \sigma_u^{-1} \mathcal{M}^{(r_2)} \sigma_u &= \mathcal{M}^{(r_1)}, \\ \sigma_u^{-1} \mathcal{M}^{(r_3)} \sigma_u &= \mathcal{M}^{(r_1)} \mathcal{M}^{(r_2)} (\mathcal{M}^{(r_1)})^{-1}. \end{aligned} \quad (3.96)$$

It holds that $\bar{\sigma}_u = \alpha \sigma_u \in \mathrm{Sp}(4, \mathbb{Z})$. We introduce moreover the translation of τ_{IJ} at weak coupling,

$$\mathcal{T}_{w,u} = \begin{pmatrix} 0 & 1 & -1 & 2 \\ 1 & 0 & 2 & -1 \\ 0 & 0 & 0 & 1 \\ 0 & 0 & 1 & 0 \end{pmatrix} = \alpha^2 \mathcal{P} \sigma_u^{-1} \in \mathrm{Sp}(4, \mathbb{Z}), \quad (3.97)$$

which maps

$$\mathcal{T}_{w,u} : \begin{pmatrix} \tau_{11} & \tau_{12} \\ \tau_{12} & \tau_{22} \end{pmatrix} \mapsto \begin{pmatrix} \tau_{22} + 2 & \tau_{12} - 1 \\ \tau_{12} - 1 & \tau_{11} + 2 \end{pmatrix}. \quad (3.98)$$

Using (3.3), one checks that σ_u maps $u \mapsto \alpha u$, while $v \mapsto v$ is left invariant. Moreover, $\sigma_u^3 : u \mapsto e^{2\pi i} u$ leaves u invariant, but acts as a monodromy on the periods,

$$\sigma_u^3 = \mathcal{P} \mathcal{T}_{w,u}^{-3} = \mathcal{M}^{(r_2)} \mathcal{M}^{(r_1)} \mathcal{M}^{(r_2)} = \begin{pmatrix} 0 & -1 & -3 & 6 \\ -1 & 0 & 6 & -3 \\ 0 & 0 & 0 & -1 \\ 0 & 0 & -1 & 0 \end{pmatrix}. \quad (3.99)$$

This corresponds to the monodromy around $u = \infty$ by construction. In a similar way, we can determine the action of the \mathbb{Z}_2 symmetry generated by $\rho : v \mapsto e^{\pi i} v$. Here, one

finds the matrix representation

$$\rho_u = \begin{pmatrix} 0 & 1 & 0 & 0 \\ 1 & 0 & 0 & 0 \\ 0 & 0 & 0 & 1 \\ 0 & 0 & 1 & 0 \end{pmatrix} \in \mathrm{Sp}(4, \mathbb{Z}). \quad (3.100)$$

This matrix conjugates the semi-classical monodromies analogous to (3.96), with σ_u replaced by ρ_u . The large u monodromy for v is trivial, $\rho_u^2 = \mathbb{1}$. We will see later that σ_u and ρ_u have a natural action on the charge vectors of the dyons that become massless at the various strongly coupled singular vacua. The full \mathbb{Z}_6 symmetry can now be represented as

$$\rho_u^{-1} \mathcal{T}_{w,u} = \mathcal{T}_q, \quad (3.101)$$

with $\mathcal{T}_q = \begin{pmatrix} \mathbb{1} & C \\ 0 & \mathbb{1} \end{pmatrix}$, where $C = \begin{pmatrix} 2 & -1 \\ -1 & 2 \end{pmatrix}$ is the Cartan matrix of $\mathrm{SU}(3)$. This represents the quantum monodromy corresponding to a rotation of the scale $\Lambda^6 \rightarrow e^{2\pi i} \Lambda^6$ [33].

Weak coupling in locus \mathcal{E}_v

We now turn to the patch with v large and perform the analogous analysis as in the above. The action of $\sigma : u \mapsto \alpha u$ on the solution (C.12–C.16) can be represented by the matrix

$$\sigma_v = \alpha^2 \begin{pmatrix} -1 & -1 & 2 & -1 \\ 1 & 0 & -1 & -1 \\ 0 & 0 & 0 & -1 \\ 0 & 0 & 1 & -1 \end{pmatrix}, \quad (3.102)$$

where now the subscript v indicates that we are in the large v regime. It satisfies $\sigma_v^3 = \mathbb{1}$ and the large v rotation is therefore a trivial monodromy. On this patch, the generator of the \mathbb{Z}_2 symmetry $\rho_v : v \mapsto e^{\pi i} v$ is more interesting. Here, instead of (3.100), we now find

$$\rho_v = \begin{pmatrix} 0 & -1 & 1 & 1 \\ 1 & 1 & -2 & -2 \\ 0 & 0 & 1 & -1 \\ 0 & 0 & 1 & 0 \end{pmatrix}. \quad (3.103)$$

Since $\rho_v^2 \neq \mathbb{1}$, $v \mapsto e^{2\pi i} v$ acts on the periods as a monodromy, while leaving v invariant. The full \mathbb{Z}_6 symmetry is again given by $\mathcal{P} \alpha^2 \rho_v^{-1} \sigma_v^{-1} = \mathcal{T}_q$, as in (3.101).

3.6.2 Strong coupling monodromies

Analytically continuing the PF solution (C.10) to strong coupling, we can compute the periods near the singularities. At the \mathbb{Z}_2 point $(u, v) = (1, 0)$, the coupling matrix can be computed explicitly and we can then use σ_u to rotate to the other \mathbb{Z}_2 points

$\underline{u} = \alpha, \alpha^2$ by means of the action (B.39). The coupling matrices at these points evaluate to

$$\Omega(1, 0) = \begin{pmatrix} 0 & 0 \\ 0 & 0 \end{pmatrix}, \quad \Omega(\alpha, 0) = \begin{pmatrix} -2 & 1 \\ 1 & -2 \end{pmatrix}, \quad \Omega(\alpha^2, 0) = \begin{pmatrix} 2 & -1 \\ -1 & 2 \end{pmatrix}. \quad (3.104)$$

The above matrices lie on the boundary $\partial\mathbb{H}_2$ of the Siegel upper half-plane. The relations among the entries are consistent with the results from Section 3.3.

The coupling matrices at the \mathbb{Z}_3 (AD) points $(\underline{u}, v) = (0, \pm 1)$ are

$$\Omega(0, 1) = \begin{pmatrix} -1 + \frac{i}{\sqrt{3}} & \frac{9-\sqrt{3}i}{6} \\ \frac{9-\sqrt{3}i}{6} & -2 + \frac{i}{\sqrt{3}} \end{pmatrix}, \quad \Omega(0, -1) = \begin{pmatrix} 1 + \frac{i}{\sqrt{3}} & \frac{3-\sqrt{3}i}{6} \\ \frac{3-\sqrt{3}i}{6} & \frac{i}{\sqrt{3}} \end{pmatrix}. \quad (3.105)$$

They lie in the interior of the Siegel upper half-space \mathbb{H}_2 .

To determine the monodromies around these singularities, we recall the formula from [33, 95]. It gives the monodromy matrix in terms of the charge vector γ of the BPS state with vanishing mass. The charge vector is a left eigenvector with unit eigenvalue. The monodromy \mathcal{M}_γ reads

$$\mathcal{M}_\gamma = \begin{pmatrix} \mathbb{1} + q \otimes p & q \otimes q \\ -p \otimes p & \mathbb{1} - p \otimes q \end{pmatrix} \quad (3.106)$$

for $\gamma = (p, q)$ with $p = (p_1, p_2)$ and $q = (q_1, q_2)$ the magnetic and electric charge vectors. In locus \mathcal{E}_u we have three singular points where two mutually local dyons become massless, respectively, while in locus \mathcal{E}_v three mutually non-local dyons become massless at each of the two singular points.

Strong coupling in locus \mathcal{E}_u

To calculate the monodromies using (3.106), we need to first choose a symplectic basis for the homology cycles. In locus \mathcal{E}_u we choose it such that two monopoles $\gamma_1 = (1, 0, 0, 0)$ and $\gamma_2 = (0, 1, 0, 0)$ become massless at $(\underline{u}, v) = (1, 0)$. For gauge group SU(N) this choice is always possible [95]. In this subsection, we will consider monodromies in locus \mathcal{E}_u , keeping $v = 0$ fixed. Restricting to this locus, a monodromy circles a point rather than a line. We denote the monodromy around the point $(\underline{u}, 0)$ in \mathcal{E}_u by $\mathcal{M}_{(\underline{u}, 0)}$. The charges of the dyons that become massless at the singular points $(\underline{u}, v) = (\alpha, 0)$ and $(\underline{u}, v) = (\alpha^2, 0)$ are obtained by acting on the periods with σ_u and σ_u^{-1} from the left, it turns out that this corresponds to acting on the charges $\gamma_{1,2}$ from the right with $-\mathcal{T}_{v,u}$

and its inverse. We find

$$\begin{aligned}\gamma_1 &= (1, 0, 0, 0), & \gamma_2 &= (0, 1, 0, 0), \\ \gamma_3 &= -\gamma_1 \mathcal{T}_{w,u} = (0, -1, 1, -2), & \gamma_4 &= -\gamma_2 \mathcal{T}_{w,u} = (-1, 0, -2, 1), \\ \gamma_5 &= -\gamma_1 \mathcal{T}_{w,u}^{-1} = (0, -1, -1, 2), & \gamma_6 &= -\gamma_2 \mathcal{T}_{w,u}^{-1} = (-1, 0, 2, -1),\end{aligned}\tag{3.107}$$

where each row corresponds to the charges of the mutually local states becoming massless at the respective points.

We will first derive the four-dimensional monodromy matrices, and then determine their action on the effective couplings constants τ_{\pm} . The monodromy around $(\underline{u}, v) = (1, 0)$ can be computed from the PF solution, it is

$$\mathcal{M}_{(1,0)} = \mathcal{M}_{\gamma_1} \mathcal{M}_{\gamma_2} = \begin{pmatrix} 1 & 0 & 0 & 0 \\ 0 & 1 & 0 & 0 \\ -1 & 0 & 1 & 0 \\ 0 & -1 & 0 & 1 \end{pmatrix}\tag{3.108}$$

and agrees with the product of the monodromies (3.106) of the singular lines associated with the massless states of charges γ_1 and γ_2 [95]. This monodromy can be written as a ‘‘trajectory’’ in the space of coupling constants as

$$\mathcal{M}_{(1,0)} = \mathcal{S} \mathcal{T}_{s,u} \mathcal{S}^{-1},\tag{3.109}$$

where \mathcal{S} is the symplectic inversion and $\mathcal{T}_{s,u}$ is the translation at strong-coupling,

$$\mathcal{S} = \begin{pmatrix} 0 & 0 & -1 & 0 \\ 0 & 0 & 0 & -1 \\ 1 & 0 & 0 & 0 \\ 0 & 1 & 0 & 0 \end{pmatrix}, \quad \mathcal{T}_{s,u} = \begin{pmatrix} 1 & 0 & 1 & 0 \\ 0 & 1 & 0 & 1 \\ 0 & 0 & 1 & 0 \\ 0 & 0 & 0 & 1 \end{pmatrix}.\tag{3.110}$$

The monodromies around $\underline{u} = \alpha$ and $\underline{u} = \alpha^2$ can be obtained from the charges of the corresponding states that become massless at the different points. Alternatively, we can write them as conjugations of $\mathcal{T}_{s,u}$. We find

$$\begin{aligned}\mathcal{M}_{(\alpha,0)} &= \mathcal{M}_{\gamma_3} \mathcal{M}_{\gamma_4} = (\mathcal{T}_{w,u}^{-1} \mathcal{S}) \mathcal{T}_{s,u} (\mathcal{T}_{w,u}^{-1} \mathcal{S})^{-1} = \begin{pmatrix} 3 & -1 & 5 & -4 \\ -1 & 3 & -4 & 5 \\ -1 & 0 & -1 & 1 \\ 0 & -1 & 1 & -1 \end{pmatrix}, \\ \mathcal{M}_{(\alpha^2,0)} &= \mathcal{M}_{\gamma_5} \mathcal{M}_{\gamma_6} = (\mathcal{T}_{w,u} \mathcal{S}) \mathcal{T}_{s,u} (\mathcal{T}_{w,u} \mathcal{S})^{-1} = \begin{pmatrix} -1 & 1 & 5 & -4 \\ 1 & -1 & -4 & 5 \\ -1 & 0 & 3 & -1 \\ 0 & -1 & -1 & 3 \end{pmatrix}.\end{aligned}\tag{3.111}$$

They satisfy the consistency condition

$$\mathcal{P}\mathcal{T}_{w,u}^{-3} = \mathcal{M}_\infty = \mathcal{M}_{(\alpha,0)}\mathcal{M}_{(1,0)}\mathcal{M}_{(\alpha^2,0)} = \begin{pmatrix} 0 & -1 & -3 & 6 \\ -1 & 0 & 6 & -3 \\ 0 & 0 & 0 & -1 \\ 0 & 0 & -1 & 0 \end{pmatrix}. \quad (3.112)$$

Due to the singularity structure, the matrices (3.108)-(3.112) are all the monodromies in the region where v is small. They all lie in $\mathrm{Sp}(4, \mathbb{Z})$, since (3.106) do.

For the elliptic locus $v = 0$, we analysed the couplings $\tau_\pm = \tau_{11} \pm \tau_{12}$ in Section 3.3. We will study here the action of \mathcal{M}_∞ and $\mathcal{M}_{(\alpha^j,0)}$ on τ_\pm . We will find for τ_- that the action of the monodromies generate a proper congruence subgroup $\Gamma^0(9) \subset \mathrm{SL}(2, \mathbb{Z})$. Therefore, the action of $\mathcal{T}_{w,u}$ and $\mathcal{T}_{s,u}$ can be represented in terms of the same two-dimensional matrix $T = \begin{pmatrix} 1 & 1 \\ 0 & 1 \end{pmatrix}$. The weak coupling shift $\mathcal{T}_{w,u}$ corresponds to the two-dimensional matrix T^3 for τ_- , while the strong coupling shift $\mathcal{T}_{s,u}$ corresponds to T . Moreover, the four-dimensional symplectic \mathcal{S} reduces to the two-dimensional modular inversion S . Since $\tau_{11} = \tau_{22}$ on \mathcal{E}_u , it is easy to show that the four-dimensional monodromies reduce to the matrices

$$\begin{aligned} \mathcal{M}_{(\infty,0)} &\mapsto M_{(\infty,0)}^- = T^{-9} = \begin{pmatrix} 1 & -9 \\ 0 & 1 \end{pmatrix}, \\ \mathcal{M}_{(1,0)} &\mapsto M_{(1,0)}^- = STS^{-1} = \begin{pmatrix} 1 & 0 \\ -1 & 1 \end{pmatrix}, \\ \mathcal{M}_{(\alpha,0)} &\mapsto M_{(\alpha,0)}^- = (T^{-3}S)T(T^{-3}S)^{-1} = \begin{pmatrix} 4 & 9 \\ -1 & -2 \end{pmatrix}, \\ \mathcal{M}_{(\alpha^2,0)} &\mapsto M_{(\alpha^2,0)}^- = (T^3S)T(T^3S)^{-1} = \begin{pmatrix} -2 & 9 \\ -1 & 4 \end{pmatrix}, \end{aligned} \quad (3.113)$$

for τ_- . They all lie in $\Gamma^0(9)$ and do in fact generate $\Gamma^0(9)$, and furthermore satisfy

$$M_{(\alpha,0)}^- M_{(1,0)}^- M_{(\alpha^2,0)}^- = M_{(\infty,0)}^-. \quad (3.114)$$

Note that there is no sign between $M_{(\infty,0)}^-$ and T^{-9} here. Of course, this sign is irrelevant for the action on τ_- . A good consistency check is that these monodromies fix the τ_- at the cusps $\tau_- = \{-3, 0, 3\}$.

The weak coupling shift $\mathcal{T}_{w,u}$ corresponds to the two-dimensional matrix $T_{w,u}$ for τ_+ , while the strong coupling shift is $T_{s,u}$. For the parameter τ_+ , the monodromies reduce

to

$$\begin{aligned}
M_{(\infty,0)}^+ &= PT_{w,u}^{-3}, \\
M_{(1,0)}^+ &= ST_{s,u}S^{-1}, \\
M_{(\alpha,0)}^+ &= (T_{w,u}^{-1}S)T_{s,u}(T_{w,u}^{-1}S)^{-1}, \\
M_{(\alpha^2,0)}^+ &= (T_{w,u}S)T_{s,u}(T_{w,u}S)^{-1},
\end{aligned} \tag{3.115}$$

which satisfy

$$M_{(\alpha,0)}^+ M_{(1,0)}^+ M_{(\alpha^2,0)}^+ = M_{(\infty,0)}^+. \tag{3.116}$$

This precisely reduces to the group Γ_{u_+} (3.61), which leaves the function u_+ invariant. As discussed in Section 3.3.3, these monodromies do not generate a congruence subgroup of $\mathrm{SL}(2, \mathbb{Z})$ if we identify $T_{w,u}$ and $T_{s,u}$ with T .

Strong coupling in locus \mathcal{E}_v

We can perform a similar analysis in the region where v is large and u small. At each of the two singular points we find that three mutually non-local states become massless. The corresponding charges are

$$\begin{aligned}
\nu_1 &= (1, 1, 0, 0), & \nu_2 &= (0, 1, 0, 0), \\
\nu_3 &= \nu_1 \bar{\sigma}_v^{-1} = (-1, 0, -1, 2), & \nu_4 &= \nu_2 \bar{\sigma}_v^{-1} = (-1, -1, 1, 1), \\
\nu_5 &= \nu_1 \bar{\sigma}_v = (0, -1, 1, -2), & \nu_6 &= \nu_2 \bar{\sigma}_v = (1, 0, -1, -1),
\end{aligned} \tag{3.117}$$

where the left column represents the states that becomes massless at $(u, v) = (0, 1)$ and the second column the ones for $(u, v) = (0, -1)$, and $\bar{\sigma}_v = \alpha \sigma_v \in \mathrm{Sp}(4, \mathbb{Z})$.

The monodromy around $v = \infty$ is given by

$$\mathcal{M}_{(0,\infty)} = \rho_v^2 = \begin{pmatrix} -1 & -1 & 4 & 1 \\ 1 & 0 & -5 & 1 \\ 0 & 0 & 0 & -1 \\ 0 & 0 & 1 & -1 \end{pmatrix}. \tag{3.118}$$

For $u = 0$, the monodromy around the AD point $(u, v) = (0, 1)$ can be calculated from the Picard-Fuchs solution,

$$\mathcal{M}_{(0,1)} = \begin{pmatrix} 2 & 0 & 1 & -2 \\ -2 & 1 & -2 & 4 \\ -1 & -1 & 1 & 0 \\ 0 & -1 & 1 & -1 \end{pmatrix} = \mathcal{M}_{\nu_1} \mathcal{M}_{\nu_3} = \mathcal{M}_{\nu_3} \mathcal{M}_{\nu_5}. \tag{3.119}$$

The remaining monodromy is fixed by the global consistency $\mathcal{M}_{(0,\infty)} = \mathcal{M}_{(0,1)}\mathcal{M}_{(0,-1)}$. This gives us

$$\mathcal{M}_{(0,-1)} = \begin{pmatrix} 0 & -1 & 1 & 1 \\ -1 & 0 & 1 & 1 \\ -1 & -1 & 2 & 1 \\ 0 & -1 & 0 & 1 \end{pmatrix} = \rho_v^{-1}\mathcal{M}_{(0,1)}\rho_v = \mathcal{M}_{\nu_2}\mathcal{M}_{\nu_4} = \mathcal{M}_{\nu_4}\mathcal{M}_{\nu_6}, \quad (3.120)$$

All of the above matrices are in $\mathrm{Sp}(4, \mathbb{Z})$. Due to the relations (3.68) among τ_{11} , τ_{12} and τ_{22} , they act on $\tau_- = \tau_{11} - \tau_{12}$ as

$$\begin{aligned} M_{(0,1)}^- &= \begin{pmatrix} -4 & -7 \\ 1 & 1 \end{pmatrix}, \\ M_{(0,-1)}^- &= \begin{pmatrix} 1 & 1 \\ -1 & 2 \end{pmatrix}, \\ M_{(0,\infty)}^- &= \begin{pmatrix} 1 & -6 \\ 0 & 1 \end{pmatrix}. \end{aligned} \quad (3.121)$$

We conjugate with $\begin{pmatrix} 1 & -1 \\ 0 & 1 \end{pmatrix}$, to match with the coupling $\tau = \tau_- + 1$ for (3.74). This reproduces precisely the matrices (3.78), which leave v invariant.

Similarly to the above, we can consider the action of the matrices $\mathcal{M}_{(0,\infty)}$ and $\mathcal{M}_{(0,\pm 1)}$ on the parameter $\tau_+ = \tau_{11} + \tau_{12}$. This gives

$$\begin{aligned} M_{(0,1)}^+ &= \begin{pmatrix} 0 & 1 \\ -3 & 3 \end{pmatrix}, \\ M_{(0,-1)}^+ &= \begin{pmatrix} -3 & 7 \\ -3 & 6 \end{pmatrix}, \\ M_{(0,\infty)}^+ &= T^{-2}, \end{aligned} \quad (3.122)$$

with again $M_{(0,1)}^+M_{(0,-1)}^+ = M_{(0,\infty)}^+$ up to normalisation. These matrices agree with what we found in Section 3.4, below (3.81).

3.6.3 BPS quiver and origin of \mathcal{U}

A potential application of the previous sections is to interpolate between weak and strong coupling. One may follow the BPS spectrum along such a trajectory using the connection to BPS quivers [73, 115, 116]. We briefly address this connection in this subsection.

Let us consider the origin of the moduli space, $(u, v) = (0, 0)$. At this point, the two elliptic loci, \mathcal{E}_u and \mathcal{E}_v , touch. It is a perfectly regular point, since $\Delta = 729\Lambda^{18}$ does not vanish. We can compute the coupling matrix at the origin of the moduli space \mathcal{U}

starting from large u , and find

$$\Omega^u(0,0) = \begin{pmatrix} 1 + \frac{\sqrt{3}}{2}i & -\frac{1}{2} \\ -\frac{1}{2} & 1 + \frac{\sqrt{3}}{2}i \end{pmatrix}. \quad (3.123)$$

The above matrix can be obtained by expanding the periods to first order in v but exact in u , computing the coupling matrix, setting $v = 0$ and taking the limit $u \rightarrow 0$ for $u < 0$. This is consistent with the argument given in [73] that the origin should be approached on the negative real u -line, as it avoids the singularity $\underline{u} = 1$ where the periods pick up a monodromy.

Analytically continuing the solutions for large v (C.16), we find that the coupling at the origin $(0,0) \in \mathcal{U}$ is given by

$$\Omega^v(0,0) = \begin{pmatrix} \frac{2i}{\sqrt{3}} & 1 - \frac{i}{\sqrt{3}} \\ 1 - \frac{i}{\sqrt{3}} & -1 + \frac{2i}{\sqrt{3}} \end{pmatrix} \quad (3.124)$$

The two different matrices (3.123) and (3.124) are related through the action (B.39) as

$$\mathcal{T}_\theta (\mathcal{M}^{(r_2)})^{-1} \mathcal{M}_{\nu_2} : \Omega^u(0,0) \mapsto \Omega^v(0,0), \quad (3.125)$$

with \mathcal{T}_θ as below (3.64). The two effective couplings at the origin $\Omega^{u,v}(0,0)$ are therefore related by a monodromy up to \mathcal{T}_θ . This is expected, since \mathcal{T}_θ transforms (3.64) to (3.29).

As shown in [73], the central charge configuration at the origin can be obtained from the one for large u by following the negative real axis on the $v = 0$ plane from large u to 0. At this point, the full \mathbb{Z}_6 -symmetry is restored and none of the central charges are zero. We find that, for example, $Z_{\nu_1} = Z_{\nu_2} = e^{\frac{9\pi i}{6}} = -i$, $Z_{\nu_3} = Z_{\nu_4} = e^{\frac{5\pi i}{6}}$ and $Z_{\nu_5} = Z_{\nu_6} = e^{\frac{\pi i}{6}}$ in the normalisation of Table C.1. Together with their charge conjugates, they all map into each other by $\frac{2\pi}{6}$ rotations. In fact, the symmetry group is larger than \mathbb{Z}_6 . Since the symmetry group for the central charges of $(\nu_j, \nu_{j+1}, -\nu_j, -\nu_{j+1})$ for $j = 1, 3, 5$ is D_4 , and the symmetry group of the equilateral triangle is D_6 , the total symmetry group becomes $D_4 \times D_6$. This group is known to be isomorphic to the group $\mathbb{Z}_3 \times D_8$, which is the automorphism group of this genus 2 curve [112]. Moreover, this group is isomorphic to $D_{12} \times \mathbb{Z}_2$, such that the automorphism group D_4 of \mathcal{E}_u , and D_{12} of \mathcal{E}_v are both subgroups of the automorphism group at the origin.

The BPS quiver for strong coupling [73] is presented in Figure 3.5. Every charge vector in the basis is represented by a node. The number of arrows is determined by the symplectic inner product between a pair of charges. The global \mathbb{Z}_2 symmetry σ_v acts in the picture to the right as $\nu_k \mapsto \nu_{k+2 \bmod 6}$.

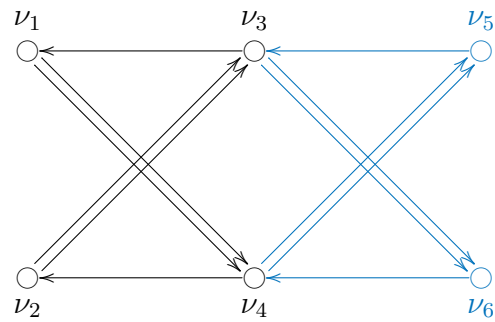

Fig. 3.5 The mutation algorithm produces a finite spectrum consisting of 6 particles at strong coupling [73]. The generating matrix $\bar{\sigma}_v = \alpha\sigma_v$ maps the charges to the right. The coloured part does not belong to the $SU(3)$ quiver, it merely highlights how all the charges at strong coupling can be obtained from $\bar{\sigma}_v$.

Chapter 4

Integrating over the u -plane

Now that we have seen how to construct fundamental domains of the running couplings in more generic SW theories we will, in this Chapter, discuss how these domains can help us when calculating correlation functions in the topologically twisted $SU(2)$ theories. Sections 4.1-4.5 are based on [5] and will address the construction and definitions of the Coulomb branch, or u -plane, integral of the theories with $N_f \leq 3$ flavours, leaving the explicit evaluations for future work [117]. The u -plane integrals have seen a recent revival of interest due to new connections to the theory of mock modular forms [43, 46]. The analyses of these papers was restricted to the case of simply connected four-manifolds. In Section 4.6, based on [4], we show how this generalises, for the pure theory, when allowing for non-simply connected four-manifolds. In the same section we further provide an explicit example of the evaluation of the u -plane integral for the pure theory on a non-simply connected manifold.

4.1 Special geometry and SW theories

We return now to the Seiberg-Witten theories with gauge group $SU(2)$ and $N_f \leq 3$ fundamental hypermultiplets. We will in this Section introduce a new set of couplings for these theories that will be crucial when defining the topologically twisted theory on an arbitrary four-manifold. For this we also need the action of the monodromies on these couplings, as well as on the running coupling τ . We derive these here.

4.1.1 Periods and couplings

As has been stated previously in this thesis, the non-perturbative effective action of $\mathcal{N} = 2$ SQCD is characterised by the prepotential $F(a, \mathbf{m})$, with \mathbf{m} again being the

mass vector $\mathbf{m} = (m_1, \dots, m_{N_f})$. The semi-classical part of F reads [25–28]

$$\begin{aligned}
F(a, \mathbf{m}) &= \frac{2i}{\pi} a^2 \log(a/\Lambda_{N_f}) - \frac{1}{2} \sum_{j=1}^{N_f} \left(n_j \frac{m_j}{\sqrt{2}} a + \frac{3i}{8\pi} m_j^2 \right) \\
&\quad - \frac{i}{4\pi} \sum_{j=1}^{N_f} \left(a + \frac{m_j}{\sqrt{2}} \right)^2 \log\left((a + \frac{m_j}{\sqrt{2}}) / \Lambda_{N_f} \right) + \left(a - \frac{m_j}{\sqrt{2}} \right)^2 \log\left((a - \frac{m_j}{\sqrt{2}}) / \Lambda_{N_f} \right) \\
&\quad + \dots,
\end{aligned} \tag{4.1}$$

where the \dots indicate further non-perturbative corrections.

The $n_j \in \mathbb{Z}$ in (4.1) are the *magnetic winding numbers* of the dual periods a_D [25, 26, 118]. These numbers seem to be only rarely discussed in the literature beyond these references.¹ Generally, the theory allows for N_f electric winding numbers for a and N_f magnetic winding numbers for a_D . These appear in the massive $N_f > 0$ theories since the Seiberg-Witten differentials now have poles with nonzero residues [25]. The choice (4.1) of the prepotential corresponds to fixing the electric winding numbers to be zero, or equivalently fixing the monodromy at infinity to map $a \rightarrow e^{\pi i} a$. Compare for example with [25, Eq. (2.17)]. In Section 4.4, we will discuss that the single-valuedness of the u -plane integral requires $n_j \equiv -1 \pmod{4}$.

Besides the period a_D dual to a we introduce the parameters $m_{D,j}$ dual to m_j by

$$m_{D,j} = \sqrt{2} \frac{\partial F}{\partial m_j}. \tag{4.2}$$

These parameters are further combined into the $(2 + 2N_f)$ -dimensional vector Π ,

$$\Pi = \begin{pmatrix} a_D \\ a \\ m_{D,1} \\ \frac{m_1}{\sqrt{2}} \\ \vdots \\ m_{D,N_f} \\ \frac{m_{N_f}}{\sqrt{2}} \end{pmatrix}. \tag{4.3}$$

This vector forms a local system over the u -plane. The elements of the vector form the symplectic form,

$$\omega_{N_f} = da_D \wedge da + \frac{1}{\sqrt{2}} \sum_{j=1}^{N_f} dm_{D,j} \wedge dm_j. \tag{4.4}$$

¹Nekrasov's partition function gives a specific choice upon expanding the function $\gamma_{\hbar}(x; \Lambda)$ in the perturbative part [28, 119].

We also introduce the couplings v_j and w_{jk} with $j, k \in 1, \dots, N_f$,

$$v_j = \sqrt{2} \frac{\partial^2 F}{\partial a \partial m_j}, \quad w_{jk} = 2 \frac{\partial^2 F}{\partial m_j \partial m_k}. \quad (4.5)$$

These will play an important role later.

4.1.2 Monodromies

Let us determine the monodromy matrices around the $N_f + 2$ singular points. We leave the winding numbers n_j , $j = 1, \dots, N_f$, for a_D generic. Starting with the monodromy around infinity, $a \rightarrow e^{\pi i} a$, we deduce from the prepotential (4.1) that the vector Π transforms as $\Pi \rightarrow \mathbf{M}_\infty \Pi$, with \mathbf{M}_∞ given by

$$\mathbf{M}_\infty = \begin{pmatrix} -1 & 4 - N_f & 0 & -n_1 & \cdots & 0 & -n_{N_f} \\ 0 & -1 & 0 & 0 & \cdots & 0 & 0 \\ 0 & n_1 & 1 & 1 & \cdots & 0 & 0 \\ 0 & 0 & 0 & 1 & \cdots & 0 & 0 \\ \vdots & \vdots & & & \ddots & & \\ 0 & n_{N_f} & 0 & 0 & \cdots & 1 & 1 \\ 0 & 0 & 0 & 0 & \cdots & 0 & 1 \end{pmatrix}. \quad (4.6)$$

The monodromy matrix \mathbf{M}_∞ is in $\mathrm{SL}(2 + 2N_f, \mathbb{Z})$, while it acts on the couplings by a symplectic transformation, i.e. it preserves the symplectic form (4.4). This can be checked by requiring that any monodromy \mathbf{M}_∞ satisfies $\mathbf{M}_\infty^T \mathbf{J} \mathbf{M}_\infty = \mathbf{J}$, with

$$\mathbf{J} = \begin{pmatrix} 0 & 1 \\ -1 & 0 \end{pmatrix}^{\oplus N_f + 1}. \quad (4.7)$$

The action on the couplings τ , v_j and w_{jk} is thus

$$\mathbf{M}_\infty : \begin{cases} \tau \rightarrow \tau + N_f - 4, \\ v_j \rightarrow -v_j - n_j, \\ w_{jk} \rightarrow w_{jk} + \delta_{jk}, \end{cases} \quad (4.8)$$

with δ_{jk} the Kronecker delta.

If we assume that the mass m_j is large, we can also deduce the monodromies around the point where a hypermultiplet becomes massless, $a = \frac{m_j}{\sqrt{2}}$, $j = 1, \dots, N_f$ from the perturbative prepotential (4.1). For a encircling $\frac{m_1}{\sqrt{2}}$ counterclockwise, $\Pi \rightarrow \mathbf{M}_1 \Pi$, we

find for the monodromy matrix \mathbf{M}_1 ,

$$\mathbf{M}_1 = \begin{pmatrix} 1 & 1 & 0 & -1 & \cdots & 0 & 0 \\ 0 & 1 & 0 & 0 & \cdots & 0 & 0 \\ 0 & -1 & 1 & 1 & \cdots & 0 & 0 \\ 0 & 0 & 0 & 1 & \cdots & 0 & 0 \\ \vdots & \vdots & & & \ddots & & \\ 0 & 0 & 0 & 0 & \cdots & 1 & 0 \\ 0 & 0 & 0 & 0 & \cdots & 0 & 1 \end{pmatrix}, \quad (4.9)$$

while the \mathbf{M}_j for other values of j are given by permutations. Its action on the couplings is

$$\mathbf{M}_j : \begin{cases} \tau \rightarrow \tau + 1, \\ v_k \rightarrow v_k - \delta_{jk}, \\ w_{kl} \rightarrow w_{kl} + \delta_{kl}\delta_{jl}. \end{cases} \quad (4.10)$$

The picture we are considering here is the analogues of Fig. 2.6 (d). In this regime of the masses, there is one monodromy with periodicity 3 and one with periodicity 1. See also [2, Fig. 10 (d)].

Besides the monodromies \mathbf{M}_∞ and \mathbf{M}_j , there are monodromies \mathbf{M}_m and \mathbf{M}_d around the points where a monopole and a dyon becomes massless, respectively. By requiring that the electro-magnetic charges of the massless particles are $(n_m, n_e) = (1, 0)$ and $(1, -2)$, respectively, we can fix the upper left blocks of the monodromies. We fix the remaining entries by assuming that the masses remains invariant, $m_j \rightarrow m_j$, and that the other periods only change by a multiple of the vanishing cycle at the corresponding cusp, together with the requirement that

$$\mathbf{M}_\infty = \mathbf{M}_m \mathbf{M}_d \prod_{j=1}^{N_f} \mathbf{M}_j. \quad (4.11)$$

For $N_f = 1$ and $n_1 = n$, this gives for \mathbf{M}_m ,

$$\mathbf{M}_m = \begin{pmatrix} 1 & 0 & 0 & 0 \\ -1 & 1 & 0 & -(n+1)/2 \\ (n+1)/2 & 0 & 1 & (n+1)^2/4 \\ 0 & 0 & 0 & 1 \end{pmatrix}. \quad (4.12)$$

This acts on the couplings as

$$\mathbf{M}_m : \begin{cases} \tau \rightarrow \frac{\tau}{-\tau+1}, \\ v \rightarrow \frac{v+(n+1)\tau/2}{-\tau+1}, \\ w \rightarrow w + \frac{(v+(n+1)/2)^2}{-\tau+1}. \end{cases} \quad (4.13)$$

The monodromy \mathbf{M}_d around the dyon singularity for $N_f = 1$ is

$$\mathbf{M}_d = \begin{pmatrix} -1 & 4 & 0 & -n-1 \\ -1 & 3 & 0 & -(n+1)/2 \\ (n+1)/2 & -n-1 & 1 & (n+1)^2/4 \\ 0 & 0 & 0 & 1 \end{pmatrix}, \quad (4.14)$$

This acts on the couplings as

$$\mathbf{M}_d : \begin{cases} \tau \mapsto \frac{-\tau+4}{-\tau+3}, \\ v \mapsto \frac{v+(n+1)\tau-n-1}{-\tau+3}, \\ w \mapsto w + \frac{(v+(n+1)/2)^2}{-\tau+3}. \end{cases} \quad (4.15)$$

We can note that all the above monodromy matrices leave the symplectic form (4.4) invariant and are independent of the masses.

For a small mass m , the fourth ‘‘hypermultiplet’’ cusp of the fundamental domain for $N_f = 1$ lies naturally near the real axis, $\tau \rightarrow 1$. See for example [2, Fig. 10 (a)], or 2.6 (a) for the $N_f = 2$ analogue. Having determined \mathbf{M}_∞ , \mathbf{M}_m and \mathbf{M}_d , we can easily determine the monodromy $\tilde{\mathbf{M}}_1$ in this regime as

$$\tilde{\mathbf{M}}_1 = \mathbf{M}_m^{-1} \mathbf{M}_\infty \mathbf{M}_d^{-1} = \begin{pmatrix} 0 & 1 & 0 & (1-n)/2 \\ -1 & 2 & 0 & (1-n)/2 \\ (n-1)/2 & (1-n)/2 & 1 & (n-1)^2/4 \\ 0 & 0 & 0 & 1 \end{pmatrix} \quad (4.16)$$

Thus for $n = -1$, the massless particle has charge $\pm(-1, 1, 0, 1)$.

We get similar monodromies for $N_f = 2, 3$. The action on the running couplings τ are the same for all N_f , by construction. The transformations of v_j and w_{jk} also take the same form for all N_f and can be summarised as

$$\begin{aligned} \mathbf{M}_m : & \begin{cases} v_j \rightarrow \frac{v_j+(n_j+1)\tau/2}{-\tau+1}, \\ w_{jk} \rightarrow w_{jk} + \frac{(v_j+(n_j+1)/2)(v_k+(n_k+1)/2)}{-\tau+1}, \end{cases} \\ \mathbf{M}_d : & \begin{cases} v_j \rightarrow \frac{v_j+(n_j+1)\tau-n_j-1}{-\tau+3}, \\ w_{jk} \rightarrow w_{jk} + \frac{(v_j+(n_j+1)/2)(v_k+(n_k+1)/2)}{-\tau+3}. \end{cases} \end{aligned} \quad (4.17)$$

4.2 The UV theory on a four-manifold

We now review various aspects of the formulation of the UV theory on a compact smooth four-manifold.

4.2.1 Aspects of four-manifolds

We let X be a smooth, compact, oriented Riemannian four-manifold, with Euler number $\chi = \chi(X)$ and signature $\sigma = \sigma(X) = b_2^+ - b_2^-$. As discussed in Sec. 1.2.3, the u -plane integral is non-vanishing only for four-manifolds X with $b_2^+ \leq 1$. In this thesis, we consider manifolds with $b_2^+ = 1$. Such four-manifolds admit a linear complex structure \mathcal{J} on the tangent space TX_p at each point p of X . The complex structure varies smoothly on X , such that TX is a complex bundle. We introduce furthermore the canonical class $K_X = -c_1(TX)$ of X , with $c_1(TX)$ the first Chern class of TX . In Sections 4.1-4.5 we mainly consider the case that also $b_1 = 0$, leaving the detailed analysis of $b_1 \neq 0$ to Section 4.6. For a manifold X with $(b_1, b_2^+) = (0, 1)$, we have that

$$K_X^2 = 8 + \sigma(X). \quad (4.18)$$

The middle cohomology $H^2(X, \mathbb{Z})$ of X gives rise to the uni-modular lattice L . More precisely, we identify L with the natural embedding of $H^2(X, \mathbb{Z})$ in $H^2(X, \mathbb{Z}) \otimes \mathbb{R}$, which mods out the torsion of $H^2(X, \mathbb{Z})$. A characteristic element $K \in L$ is an element which satisfies $\mathbf{l}^2 + B(K, \mathbf{l}) \in 2\mathbb{Z}$ for all $\mathbf{l} \in L$. The Riemann-Roch theorem demonstrates that the canonical class K_X of X is a characteristic element of L . The Wu formula furthermore shows that any characteristic vector K of L is a lift of $w_2(X)$.

The quadratic form Q of the lattice L for a 4-manifold with $(b_1, b_2^+) = (0, 1)$ can be brought to a simple standard form depending on whether Q is even or odd [120]. This divides such manifolds into two classes, for which the evaluation of their u -plane integrals needs to be done separately [46, 117]. The period point $J \in H^2(X, \mathbb{R})$ is defined as the unique class in the forward light cone of $H^2(X, \mathbb{R})$ that satisfies $J = *J$ and $J^2 = 1$.

All four-manifolds without torsion and even intersection form admit a Spin structure. More generally, for any oriented four-manifold one can define a $\text{spin}_{\mathbb{C}}$ -structure. The group $\text{spin}_{\mathbb{C}}(4)$ can be defined as pairs of unitary 2×2 matrices with coinciding determinant,

$$\text{spin}_{\mathbb{C}}(4) = \{(u_1, u_2) \in \text{U}(2) \times \text{U}(2) \mid \det u_1 = \det u_2\}. \quad (4.19)$$

There exists a short exact sequence

$$1 \longrightarrow \text{U}(1) \longrightarrow \text{spin}_{\mathbb{C}}(4) \longrightarrow \text{SO}(4) \longrightarrow 1. \quad (4.20)$$

A $\text{spin}_{\mathbb{C}}$ -structure \mathfrak{s} on a four-manifold X is then a reduction of the structure group of the tangent bundle on X , i.e. $\text{SO}(4)$, to the group $\text{spin}_{\mathbb{C}}(4)$. The different $\text{spin}_{\mathbb{C}}$ -structures correspond to the inequivalent ways of choosing transition functions of the tangent bundle such that the cocycle condition is satisfied. The $\text{spin}_{\mathbb{C}}$ -structure defines

two rank two hermitian vector bundles W^\pm . We let $c(\mathfrak{s})$ be the first Chern class of the determinant bundles, $c(\mathfrak{s}) := c_1(\det W^\pm) \in H^2(X, \mathbb{Z})$.

If \mathfrak{s} is the canonical $\text{spin}_\mathbb{C}$ structure associated to an almost complex structure on X , then $c(\mathfrak{s})^2 = 2\chi + 3\sigma$. More generally,

$$c_1(\mathfrak{s})^2 \equiv \sigma \pmod{8}. \quad (4.21)$$

4.2.2 Topological twisting with background fluxes

We discuss in this section topological twisting of theories with fundamental hypermultiplets including background fluxes. The discussion is parallel to the case of $\mathcal{N} = 2^*$ [39], where the hypermultiplet is in the adjoint representation of the gauge group and generalises the discussion in Sec. 1.2.2 by the inclusion of background fluxes.

We let $(E \rightarrow X, \nabla)$ be a principal $\text{SU}(2)/\mathbb{Z}_2 \cong \text{SO}(3)$ -bundle with connection ∇ . The second Stiefel-Whitney class $w_2(E) \in H^2(X, \mathbb{Z}_2)$ measures the obstruction to lift E to an $\text{SU}(2)$ bundle, which will exist locally but not globally if $w_2(E) \neq 0$. We denote a lift of $w_2(E)$ to the middle cohomology lattice L by $\bar{w}_2(E) \in L$, and define the 't Hooft flux $\boldsymbol{\mu} = \bar{w}_2(E)/2 \in L/2$. The instanton number of the principal bundle is defined as $k = -\frac{1}{4} \int_X p_1(E)$ and satisfies $k \in -\boldsymbol{\mu}^2 + \mathbb{Z}$, where p_1 is the first Pontryagin class.

To formulate the theories with N_f fundamental hypermultiplets on a compact four-manifold, we perform a topological twist. Coupling the four-dimensional $\mathcal{N} = 2$ $\text{SU}(2)$ theory to background fields means choosing two sets of data:

- A principal $\text{SU}(2)_R$ R-symmetry bundle, with connection ∇_R ,
- and a principal bundle \mathcal{L} with connection for global symmetries (the flavour symmetries) [39].

As mentioned already in Sec. 1.2.2, the relevant twist for the $\mathcal{N} = 2$ supersymmetry algebra in four dimensions is the Donaldson-Witten twist which is the local identification of the $\text{SU}(2)_+$ with the diagonal subgroup of the $\text{SU}(2)_+ \times \text{SU}(2)_R$ factor of the spin lift of the local spin group $\text{Spin}(4) \cong \text{SU}(2)_+ \times \text{SU}(2)_-$ [37]. Alternatively, one can view the fields as sections of a non-trivial R-symmetry bundle, isomorphic to the spin bundle S^+ . Application of this to the representations of the vector multiplet (1.1) and (1.2) gives:

$$\begin{aligned} \text{bosons:} & \quad (\mathbf{2}, \mathbf{2}) \oplus (\mathbf{1}, \mathbf{1}) \oplus (\mathbf{1}, \mathbf{1}), \\ \text{fermions:} & \quad (\mathbf{2}, \mathbf{2}) \oplus (\mathbf{3}, \mathbf{1}) \oplus (\mathbf{1}, \mathbf{1}). \end{aligned} \quad (4.22)$$

Thus the bosons remain unchanged, a vector and a complex scalar, while the fermions reorganise to a vector, self-dual two-form and real scalar, which we denote as ψ , χ and η , respectively. We note that none of these fields are spinors, and can thus be considered on a non-spin four-manifold. The original supersymmetry generators also transform in the representations for the fermions above. Thus the theory contains a

scalar fermionic supercharge $\mathcal{Q} = \epsilon^{AB} \overline{\mathcal{Q}}_{AB}$, whose cohomology provides the operators in the topological theory [37]. As we discussed also in Sec. 1.2.2.

For the fields of a hypermultiplet, (1.3) and (1.4), one finds

$$\begin{aligned} \text{bosons:} & \quad (\mathbf{1}, \mathbf{2}) \oplus (\mathbf{1}, \mathbf{2}), \\ \text{fermions:} & \quad (\mathbf{2}, \mathbf{1}) \oplus (\mathbf{1}, \mathbf{2}) \oplus (\mathbf{2}, \mathbf{1}) \oplus (\mathbf{1}, \mathbf{2}). \end{aligned} \tag{4.23}$$

Thus hypermultiplet bosons become spinors, i.e. sections of the spin bundle S^+ , while the fermions are sections of S^+ and S^- . The twisted hypermultiplets can in this case therefore only be formulated on four-manifolds which are spin, i.e. $w_2(X) = 0$ [121, 40].

However, if the hypermultiplets are charged under a gauge field or flux, the product of these bundles with S^\pm may be a $\text{spin}_\mathbb{C}$ bundle, W^+ or W^- [121, 16, 39]. The latter are defined for arbitrary four-manifolds. For example, an almost complex structure on X determines two canonical $\text{spin}_\mathbb{C}$ bundles $W^\pm \simeq S^\pm \otimes K_X^{-1/2}$ with K_X the canonical class determined by the almost complex structure. Since the hypermultiplets are in the fundamental, two-dimensional representation of $\text{SU}(2)$, the topologically twisted hypermultiplets are well-defined on a non-spin four-manifold if $\boldsymbol{\mu} = -K_X/2$ [40].

Let us state this also in terms of the gauge bundle E . To this end, we label the two components of the fundamental, two-dimensional representation of $\text{SU}(2)$ by \pm . The two components are sections of a line bundle $\mathcal{L}_E^{\pm 1/2}$ with $c_1(\mathcal{L}_E) = \bar{w}_2(E)$. Of course, the square root $\mathcal{L}_E^{1/2}$ only exists if $w_2(E) \in 2L$. On the other hand, the physical requirement is that $S^+ \otimes \mathcal{L}_E^{1/2}$ is well defined, or $\bar{w}_2(X) + \bar{w}_2(E) \in 2L$. Therefore, the obstructions can cancel each other for a suitable choice of $w_2(E)$. Thus the topological twisted theory is not well-defined for an arbitrary choice of 't Hooft flux $\boldsymbol{\mu} := \frac{1}{2}\bar{w}_2(E)$; but rather $\boldsymbol{\mu}$ has to satisfy $\boldsymbol{\mu} = \frac{1}{2}\bar{w}_2(X) \pmod{L}$ [40], or

$$\bar{w}_2(X) = \bar{w}_2(E) \pmod{2L}. \tag{4.24}$$

To consider more general 't Hooft fluxes $\boldsymbol{\mu}$ or equivalently $w_2(E)$, we can couple the j 'th hypermultiplet to a background flux or line bundle \mathcal{L}_j , with \mathcal{L}_j possibly different for each j . We let $\mathcal{E}_j = \mathcal{L}_E \otimes \mathcal{L}_j$. Then the requirement that $S^\pm \otimes \mathcal{E}_j^{\pm 1/2}$ is globally well-defined is that

$$c_1(\mathcal{E}_j) \in \bar{w}_2(X) + 2L, \tag{4.25}$$

which can be satisfied for any $\bar{w}_2(E)$ for a suitable choice of \mathcal{L}_j . Thus we can formulate the u -plane integral for arbitrary $\bar{w}_2(E)$, if we require that the background fluxes satisfy

$$c_1(\mathcal{L}_j) \in \bar{w}_2(X) + \bar{w}_2(E) + 2L, \tag{4.26}$$

for each j . This is consistent with (4.24) for $c_1(\mathcal{L}_j) = 0$.

The Chern classes $c_1(\mathcal{L}_j)$ can also be seen as the splitting classes of the $\text{Spin}(2N_f)$ principal bundle \mathcal{L} . The Chern class of \mathcal{L} reads

$$c(\mathcal{L}) = \sum_{l=0}^2 c_l(\mathcal{L}) = \prod_{j=1}^{N_f} (1 + c_1(\mathcal{L}_j)). \quad (4.27)$$

The scalar generators of the equivariant cohomology of $\text{Spin}(2N_f)$ are the masses m_j , which generate the N_f -dimensional Cartan subalgebra of $\text{Spin}(2N_f)$. The gauge bundle E_k is also $\text{Spin}(2N_f)$ equivariant. For generic masses, the flavour group is $U(1)^{N_f}$, and is enhanced for special loci of the masses, for example to $U(N_f)$ for equal masses [8].

The \mathcal{Q} -fixed equations are the non-Abelian monopole equations with N_f matter fields, M^j , in the fundamental representation. For generic gauge group G and with representation R , these equations read [122]

$$\begin{aligned} (F_{\dot{\alpha}\dot{\beta}}^a)^+ + \frac{i}{2} \sum_{j=1}^{N_f} \bar{M}_{(\dot{\alpha}}^j T^a M_{\dot{\beta})}^j &= 0, \\ \not{D}M^j = \sum_{\mu} \sigma^{\mu} D_{\mu}M^j &= 0, \end{aligned} \quad (4.28)$$

where T^a is a generator of the Lie algebra in the representation R . Including the sum over matrix elements, we have

$$M_{(\alpha}^j T^a M_{\beta)}^j = \sum_{k,l} (M^j)_{(\alpha}^k (T^a)^{kl} (M^j)_{\beta)}^l. \quad (4.29)$$

We denote the moduli space of solutions to (4.28) by $\mathcal{M}_{k,\mathcal{L}_j}^{Q,N_f}$, and leave the dependence on the 't Hooft flux $\boldsymbol{\mu}$ and the metric J implicit. For $N_f = 4$ on $X = \mathbb{CP}^2$, such moduli spaces are studied in [123].

The moduli spaces $\mathcal{M}_{k,\mathcal{L}_j}^{Q,N_f}$ are non-compact for vanishing masses [124–126]. This is improved upon by turning on masses and localising with respect to the $U(1)^{N_f}$ flavour symmetry, $M_{\alpha}^j \rightarrow e^{i\varphi_j} M_{\alpha}^j$, which leave invariant the \mathcal{Q} -fixed equations (4.28). There are two components:

- the instanton component, with $F^+ = 0$ and $M^j = 0$, $j = 1, \dots, N_f$. The moduli space for this component is denoted \mathcal{M}_k^i . Since the hypermultiplet fields vanish, this component is associated to the Coulomb branch.
- the abelian or monopole component, for which a $U(1)$ subgroup of the flavour group acts as pure gauge. Here the connection is reducible, and a $U(1)$ subgroup of the $SU(2)$ gauge group is preserved. For generic masses, there are N_f such components, where M^{ℓ} is upper or lower triangular for some ℓ , and $M^j = 0$ for all $j \neq \ell$. The moduli space of this component is denoted $\mathcal{M}_k^{a,j}$, $j = 1, \dots, N_f$. Since some of the hypermultiplet fields are non-vanishing, this component is associated to the Higgs branch [125, 127].

The instanton component \mathcal{M}_k^i is non-compact due to point-like instantons. This can be cured using the Uhlenbeck compactification or algebraic-geometric compactifications. We assume that the physical path integral chooses a specific compactification, whose details are however not manifest at the level of the low energy effective field theory other than that the compactification must be in agreement with the correlation functions.

The topological twist for $\mathcal{N} = 2$ supersymmetric QCD can be further made dependent on a cocycle $\zeta_{\alpha\beta\gamma}^{\text{gauge}}$ representing the 't Hooft flux, and $\zeta_{\alpha\beta\gamma}^s$ a cocycle representing $w_2(X)$ (the cocycles are the U(1) valued functions measuring the obstruction of the cocycle condition for transition functions) [39]. Without additional line bundles, $\bar{w}_2(X) = \bar{w}_2(E)$ is equivalent to the cocycle $\zeta_{\alpha\beta\gamma}^{\text{gauge}} \zeta_{\alpha\beta\gamma}^s$ being trivialisable. We leave it for future work to explore whether the invariants depend on the choice of trivialisation.

4.2.3 Correlation functions and moduli spaces

The \mathcal{Q} -fixed equations (4.28) include a Dirac equation for each hypermultiplet $j = 1, \dots, N_f$ in the fundamental representation. The corresponding index bundle W_k^j defines an element of the K -group of \mathcal{M}_k^i . Its virtual rank $\text{rk}(W_k^j)$ is the formal difference of two infinite dimensions. It is given by an index theorem and reads

$$\text{rk}(W_k^j) = -k + \frac{1}{4}(c_1(\mathcal{L}_j)^2 - \sigma) \in \mathbb{Z}, \quad (4.30)$$

where $c_1(\mathcal{L}_j)$ is the first Chern class of the bundle \mathcal{L}_j . Note that the rhs is *not* an integer for an arbitrary $c_1(\mathcal{L}_j) \in H^2(X, \mathbb{Z})$. To verify that the rhs is integral for the $c_1(\mathcal{L}_j)$'s satisfying (4.26), we rewrite $\text{rk}(W_k^j)$ as

$$\text{rk}(W_k^j) = -(k + \boldsymbol{\mu}^2) - c_1(\mathcal{L}_j) \cdot \boldsymbol{\mu} + \frac{1}{4} \left((c_1(\mathcal{L}_j) + 2\boldsymbol{\mu})^2 - \sigma \right). \quad (4.31)$$

Then the first term on the rhs is an integer since $k \in -\frac{1}{4}w_2(E)^2 + \mathbb{Z}$ for an SO(3) bundle. The second term is an integer because $c_1(\mathcal{L}_j) \cdot \boldsymbol{\mu} = (\bar{w}_2(X) - 2\boldsymbol{\mu}) \cdot \boldsymbol{\mu} \pmod{\mathbb{Z}} \in \mathbb{Z}$, and the third term is an integer using (4.21) and the fact that $c_1(\mathcal{L}_j) + 2\boldsymbol{\mu}$ equals the characteristic class of a spin_c -structure \mathfrak{s}_j by (4.26),

$$c_1(\mathcal{L}_j) + 2\boldsymbol{\mu} = c(\mathfrak{s}_j), \quad (4.32)$$

for each j .

The mass m_j is the equivariant parameter of the U(1) flavour symmetry associated to the j 'th hypermultiplet. The equivariant Chern class of W_k^j reads in terms of the splitting class x_l ,

$$c(W_k^j) = \prod_{l=0}^{-\text{rk}(W_k^j)} (x_l + m_j) = m_j^{-\text{rk}(W_k^j)} \sum_l \frac{c_l(W_k^j)}{m_j^l}. \quad (4.33)$$

We abbreviate $c_l(W_k^j)$ to $c_{l,j}$, and let $c(W_k) = \prod_{j=1}^{N_f} c(W_k^j)$.

The moduli space $\mathcal{M}_{k,\mu,\mathcal{L}_j}^Q$ for N_f hypermultiplets corresponds to the vanishing locus of the obstructions for the existence of N_f zero modes of the Dirac operator. As a result, the virtual complex dimension of the moduli space $\mathcal{M}_{k,\mu,\mathcal{L}_j}^Q$ is that of the instanton moduli space plus the sum of (typically negative) ranks of the index bundles W_k^j , $\text{vdim}(\mathcal{M}_{k,\mathcal{L}_j}^{Q,N_f}) = \text{vdim}(\mathcal{M}_k^Q)_{N_f=0} + \sum_{j=1}^{N_f} \text{rk}(W_k^j)$ [128, 124, 129, 39]. This gives

$$\text{vdim}(\mathcal{M}_{k,\mathcal{L}_j}^{Q,N_f}) = (4 - N_f)k + \frac{1}{4} \left(-3\chi - (3 + N_f)\sigma + \sum_{j=1}^{N_f} c_1(\mathcal{L}_j)^2 \right). \quad (4.34)$$

It is argued in [130] that the inclusion of massive matter amounts to inserting an integral of the equivariant Euler class of the Dirac index bundle over the moduli space. Therefore, the correlation functions are the generating functions for the intersection numbers of the standard Donaldson observables and the Poincaré duals to the Chern classes of the various vector bundles.

The correlation functions on X in the theory with N_f massive fundamental hypermultiplets are conjectured to be [130]

$$\langle \mathcal{O}_1 \dots \mathcal{O}_p \rangle = \sum_k \Lambda_{N_f}^{\text{vdim}(\mathcal{M}_{k,\mathcal{L}_j}^{Q,N_f})} \int_{\mathcal{M}_{k,\mathcal{L}_j}^{Q,N_f}} c(W_k) \omega_1 \wedge \dots \wedge \omega_p. \quad (4.35)$$

Here $\omega_i = \mu(\mathcal{O}_i)$ are the Donaldson classes associated to the physical observable \mathcal{O}_i , and $c(M)$ is the Euler class of the matter bundle [131–134]. Localising to the fixed point locus in $\mathcal{M}_{k,\mathcal{L}_j}^{Q,N_f}$ with respect to $U(1)^{N_f}$ gives

$$\langle \mathcal{O}_1 \dots \mathcal{O}_p \rangle = \sum_k \Lambda_{N_f}^{\text{vdim}(\mathcal{M}_{k,\mathcal{L}_j}^{Q,N_f})} \int_{\mathcal{M}_k^i \cup \mathcal{M}_k^a} \left(\prod_{j=1}^{N_f} m_j^{-\text{rk}(W_k^j)} \sum_l \frac{\sigma_{j,l}}{m_j^l} \right) \omega_1 \wedge \dots \wedge \omega_p. \quad (4.36)$$

where the integral is over the union $\mathcal{M}_k^i \cup \mathcal{M}_k^a$ of the instanton component \mathcal{M}_k^i [130, Eq. (5.13)] and the monopole component \mathcal{M}_k^a [39, 29]. The equation together with the dimension of the moduli spaces (4.34) demonstrate a selection rule for observables together with powers of Λ_{N_f} and m_j .

In the decoupling limit $m_{N_f} \rightarrow \infty$, $\Lambda_{N_f} \rightarrow 0$ (2.2), the only contribution for $j = N_f$ is from $l = 0$, $c_{0,N_f} = 1$. The powers of m_j and Λ_{N_f} work out such that the correlation functions reduce to those of the theory with $N_f - 1$ hypermultiplets [135]

$$\langle \mathcal{O}_1 \dots \mathcal{O}_p \rangle_{N_f} \rightarrow \left(\frac{\Lambda_{N_f}}{\Lambda_{N_f-1}} \right)^\alpha \langle \mathcal{O}_1 \dots \mathcal{O}_p \rangle_{N_f-1}, \quad (4.37)$$

We deduce from (4.36) that

$$\begin{aligned} \alpha &= \text{vdim}(\mathcal{M}_k^{Q, N_f}) + (4 - N_f) \text{rk}(W_k^{N_f}) \\ &= \frac{1}{4} \left(-3\chi - 7\sigma + (5 - N_f) c_1(\mathcal{L}_{N_f})^2 + \sum_{j=1}^{N_f-1} c_1(\mathcal{L}_j)^2 \right). \end{aligned} \quad (4.38)$$

The overall factor can be accounted for by an overall renormalisation in the decoupling limit.

The correlation function has a smooth massless limit $m_j \rightarrow 0$, for which only terms with the top Chern classes contribute. These are given by

$$\langle \mathcal{O}_1 \dots \mathcal{O}_p \rangle = \sum_k \prod_{j=1}^{N_f} \Lambda_{N_f}^{\text{vdim}(\mathcal{M}_{k, \mathcal{L}_j}^{Q, N_f})} \int_{\mathcal{M}_k^i \cup \mathcal{M}_k^a} c_{l_j, j} \omega_1 \wedge \dots \wedge \omega_p \quad (4.39)$$

with $l_j = -\text{rk}(W_k^j)$ for each $c_{l_j, j}$. For a non-vanishing result, the degree of $\omega_1 \dots \omega_p$ must equal $\text{vdim}(\mathcal{M}_{k, \mathcal{L}_j}^{Q, N_f})$.

4.3 The effective theory on a four-manifold

We consider in this Section the low energy effective field theory on a four-manifold. We derive the semi-classical action of the theory coupled to background U(1) fields. As in previous cases [42, 40, 136, 39], the final expression takes the form of a Siegel-Narain theta series multiplied by a measure factor.

4.3.1 Hypermultiplets and background fields

The effective theory coupled to N_f background fluxes can be modelled as that of a theory with gauge group $\text{SU}(2) \times \text{U}(1)^{N_f}$, where the fields of the U(1) factors have been frozen in a special way [137, 39]. To derive the precise form, we recall the low-energy effective Lagrangian for the r multiplets $(\phi^J, \eta^J, \chi^J, \psi^J, F^J)$ of the topologically twisted $\text{U}(1)^r$ SYM theory [19]. Since the u -plane integral reduces to an integral over zero-modes [40], it suffices to only include the zero-modes in the Lagrangian. For simply connected four-manifolds, there is no contribution from the one-form fields ψ^J . The Lagrangian is then given in terms of the prepotential $F(\{a^J\})$ and its derivatives to the vevs $\langle \phi^J \rangle = a^J$, as

$$\begin{aligned} \mathcal{L} &= \frac{i}{16\pi} (\bar{\tau}_{JK} F_+^J \wedge F_+^K + \tau_{JK} F_-^J \wedge F_-^K) - \frac{1}{8\pi} y_{JK} D^J \wedge D^K \\ &\quad + \frac{i\sqrt{2}}{16\pi} \bar{\mathcal{F}}_{JKL} \eta^J \chi^K \wedge (D + F_+)^L, \end{aligned} \quad (4.40)$$

with $y_{JK} = \text{Im}(\tau_{JK})$, $\tau_{JK} = \partial_J \partial_K F(\{a^J\})$ and $\mathcal{F}_{JKL} = \partial_J \partial_K \partial_L F(\{a^J\})$. It is left invariant by the BRST operator \mathcal{Q} , which acts on the zero modes as

$$\begin{aligned} [\mathcal{Q}, A^J] &= \psi^J = 0, & [\mathcal{Q}, \psi^J] &= 4\sqrt{2}da^J, \\ [\mathcal{Q}, a^J] &= 0, & [\mathcal{Q}, \bar{a}^J] &= \sqrt{2}i\eta^J, \\ [\mathcal{Q}, \eta^J] &= 0, & [\mathcal{Q}, \chi^J] &= i(F_+ - D_+)^J, \\ [\mathcal{Q}, D^J] &= (d\psi^J)_+ = 0. \end{aligned} \tag{4.41}$$

Using this operator, we can write \mathcal{L} as the sum of a topological, holomorphic term and a \mathcal{Q} -exact term,

$$\mathcal{L} = \frac{i}{16\pi} \tau_{JK} F^J \wedge F^K + \{\mathcal{Q}, W\}, \tag{4.42}$$

with

$$W = -\frac{i}{8\pi} y_{JK} \chi^J (F_+ + D)^K. \tag{4.43}$$

The low-energy theory of SU(2) gauge theory with N_f hypermultiplets coupled to N_f background fluxes can then be modelled by the above rank r description with $r = N_f + 1$. We identify $F(\{a^J\})$ with $F(a, \mathbf{m})$. We let the indices J, K run from 0 to N_f and identify the index 0 with the unbroken U(1) of the SU(2) gauge group and the indices $j, k, l = 1, \dots, N_f$ with that of the frozen U(1) N_f factors. We further set $\phi^0 := \phi$ for any field ϕ . We will proceed by using lower indices for j, k, l , except where the summation convention is explicitly used, to avoid confusion with powers of the fields.

The masses of the hypermultiplets are the vevs of the frozen scalar fields of the corresponding vector multiplets, $\frac{m_j}{\sqrt{2}} = \langle \phi_j \rangle = a_j$ [137]. We set $[F_j] = 4\pi \mathbf{k}_j$ with

$$\mathbf{k}_j = c_1(\mathcal{L}_j)/2 \in L/2. \tag{4.44}$$

To make the BRST variations of the fields from the frozen U(1) factors vanish, we set $\eta_j = \chi_j = 0$, as well as $D^j = F_+^j$. With these identifications, the Lagrangian becomes

$$\begin{aligned} \mathcal{L} &= \frac{i}{16\pi} \tau_{JK} F^J \wedge F^K + \frac{1}{8\pi} y_{00} F_+ \wedge F_+ - \frac{1}{8\pi} y_{00} D \wedge D \\ &+ \frac{i\sqrt{2}}{16\pi} \bar{\mathcal{F}}_{000} \eta \chi \wedge (D + F_+) + \frac{i\sqrt{2}}{8\pi} \bar{\mathcal{F}}_{00j} \eta \chi \wedge F_+^j \\ &+ \frac{1}{4\pi} y_{0j} (F_+ - D) \wedge F_+^j. \end{aligned} \tag{4.45}$$

Integrating over D , η and χ in the standard way [19, 40, 39], we end up with

$$\begin{aligned} &\int dD d\eta d\chi e^{-\int_X \mathcal{L}} \\ &= \frac{\partial}{\partial \bar{a}} \left(i\sqrt{y_{00}} B \left(F + \frac{y_{0j}}{y_{00}} F^j, J \right) \right) e^{-\int_X \mathcal{L}_0}, \end{aligned} \tag{4.46}$$

where

$$\begin{aligned}
\mathcal{L}_0 &= \frac{i}{16\pi} \tau_{JK} F^J \wedge F^K + \frac{1}{8\pi} y_{00} F_+ \wedge F_+ + \frac{y_{0j}}{4\pi} F_+ \wedge F_+^j + \frac{1}{8\pi} \frac{y_{0j} y_{0k}}{y_{00}} F_+^j \wedge F_+^k \\
&= \frac{i}{16\pi} (\bar{\tau} F_+ \wedge F_+ + \tau F_- \wedge F_-) + \frac{i}{8\pi} (v_j F_- \wedge F_-^j + \bar{v}_j F_+ \wedge F_+^j) \\
&\quad + \frac{i}{16\pi} w_{jk} F^j \wedge F^k + \frac{y}{8\pi} \text{Im}(v_j) \text{Im}(v_k) F_+^j \wedge F_+^k,
\end{aligned} \tag{4.47}$$

and we identified $\tau := \tau_{00}$, $y = \text{Im}(\tau) = y_{00}$, $v_j := \tau_{0j}$ and $w_{jk} := \tau_{jk}$. Thus the coupling w_{jk} is holomorphic, but the coupling v_j is *non-holomorphic*. This is similar to the couplings for $\mathcal{N} = 2^*$ [39].

4.3.2 Sum over fluxes

The path integral includes a sum over fluxes $\mathbf{k} = [F]/4\pi \in L/2$. After summing the exponentiated action (4.46) over the fluxes \mathbf{k} and multiplying by $\frac{d\bar{a}}{d\bar{\tau}}$, we find that this takes the form

$$\sum_{\mathbf{k} \in L+\mu} \int dD d\eta d\chi e^{-\int_X \mathcal{L}} = \left(\prod_{j,k=1}^{N_f} C_{jk}^{B(\mathbf{k}_j, \mathbf{k}_k)} \right) \Psi_\mu^J(\tau, \bar{\tau}, \mathbf{z}, \bar{\mathbf{z}}). \tag{4.48}$$

The couplings C_{jk} are given in terms of w_{jk} (4.5) by

$$C_{jk} = e^{-\pi i w_{jk}}, \tag{4.49}$$

for $j, k = 1, \dots, N_f$. Such couplings were first put forward in [136], and were also crucial in [39].

The term Ψ_μ^J is an example of a Siegel-Narain theta function. It reads explicitly

$$\begin{aligned}
\Psi_\mu^J(\tau, \bar{\tau}, \mathbf{z}, \bar{\mathbf{z}}) &= e^{-2\pi y \mathbf{b}_+^2} \sum_{\mathbf{k} \in L+\mu} \partial_{\bar{\tau}} (4\pi i \sqrt{y} B(\mathbf{k} + \mathbf{b}, J)) \\
&\quad \times (-1)^{B(\mathbf{k}, K)} q^{-\mathbf{k}_-^2/2} \bar{q}^{\mathbf{k}_+^2/2} e^{-2\pi i B(\mathbf{z}, \mathbf{k}_-) - 2\pi i B(\bar{\mathbf{z}}, \mathbf{k}_+)},
\end{aligned} \tag{4.50}$$

and is discussed in more detail in Appendix B.2. The elliptic variable reads in terms of v_j and \mathbf{k}_j ,

$$\mathbf{z} = \sum_{j=1}^{N_f} v_j \mathbf{k}_j, \quad \text{and} \quad \mathbf{b} = \frac{\text{Im}(\mathbf{z})}{y}, \tag{4.51}$$

thus inducing a non-holomorphic dependence on v_j . Furthermore, K appearing in the fourth root of unity $(-1)^{B(\mathbf{k}, K)}$ is a characteristic vector of L . Note that Ψ_μ^J changes by the sign $(-1)^{B(\mu, K-K')}$ upon replacing K by a different characteristic vector K' [40, 138, 39].

For $N_f = 0$, this phase can be understood as arising from integrating out massive fermionic modes [42]. It also appears naturally in decoupling the adjoint hypermultiplet

in the analogous function for $\mathcal{N} = 2^*$ [39]. For $N_f > 0$, the constant part of the couplings v_j (4.5) effectively contribute to the phase, such that the total phase reads

$$e^{\pi i B(\mathbf{k}, K)} \prod_{j=1}^{N_f} e^{\pi i n_j B(\mathbf{k}_j, \mathbf{k})}, \quad (4.52)$$

with n_j the magnetic winding numbers. For arbitrary $n_j \in \mathbb{Z}$, the phase is an eighth root of unity. It would be interesting to understand this phase from integrating out massive modes.

We deduce from (4.52) that the summand of Ψ_μ^J changes by a phase

$$e^{\pi i (n'_j - n_j) B(\mathbf{k}_j, \mathbf{k})} \quad (4.53)$$

if the winding numbers n_j are replaced by n'_j . Since $\mathbf{k}_j \in K/2 - \boldsymbol{\mu} \pmod L$ (see (4.26)) and $\mathbf{k} \in L + \boldsymbol{\mu}$, this phase is 1 if $n'_j - n_j = 0 \pmod 4$. We can therefore restrict to $n_j \in \mathbb{Z}_4$. For specific choices of $\boldsymbol{\mu}$ and \mathbf{k}_j , the n_j can lie in a subgroup of \mathbb{Z}_4 .

The modular transformations of Ψ_μ^J are discussed in Appendix B.2, which are crucial input for single-valuedness of the u -plane integrand. We will demonstrate in Section 4.4.2 that the u -plane integrand is single-valued if we impose further constraints on the winding numbers n_j .

Finally, if the theory is considered on a curved background, topological couplings arise in the effective field theory [42]. These terms couple to the Euler characteristic and the signature of the four-manifold X , respectively denoted A and B . These take the form [42, 40],

$$A = \alpha \left(\frac{du}{da} \right)^{1/2}, \quad B = \beta \Delta_{N_f}^{1/8}. \quad (4.54)$$

Here, Δ_{N_f} is the physical discriminant incorporating the singularities of the effective theory, while $\frac{du}{da}$ is the (reciprocal of) the periods of the SW curves as introduced in Chapter 2. As discussed in that chapter, both can be determined directly from the SW curve. The prefactors α and β are independent of u , but can be functions of other moduli such as the masses \mathbf{m} , the dynamical scale Λ_{N_f} or the UV coupling τ_{UV} . However, it turns out that for the theories with fundamental matter they are independent of the masses and only depend on the scale [135, 139]. They satisfy several constraints from holomorphy, RG flow, homogeneity and dimensional analysis, and can in principle be fixed for any Lagrangian theory from a computation in the Ω -background [44, 135, 139, 61].

4.3.3 Observables and contact terms

The observables in the topologically twisted theories are the point observable or 0-observable u , as well as d -observables supported on a d -dimensional submanifold of X .

The d -observables are only non-vanishing if the submanifold corresponds to a non-trivial homology class. For $b_1 = 0$, the d -observables with d odd therefore do not contribute. In Section 4.6 we will consider the case of $b_1 \neq 0$ when evaluating the u -plane integral for the pure theory, until then we restrict to $b_1 = 0$ for brevity.

To introduce the surface observable, let $\mathbf{x} \in H_2(X, \mathbb{Q})$. Then the surface observable reads in terms of the UV fields,

$$I(\mathbf{x}) = \frac{1}{4\pi^2} \int_{\mathbf{x}} \text{Tr} \left[\psi \wedge \psi - \frac{1}{\sqrt{2}} \phi F \right]. \quad (4.55)$$

In the effective infrared theory, this operator becomes,

$$\tilde{I}(\mathbf{x}) = \frac{i}{\sqrt{2\pi}} \int_{\mathbf{x}} \frac{1}{32} \frac{d^2 u}{da^2} \psi \wedge \psi - \frac{\sqrt{2}}{4} \frac{du}{da} (F_- + D). \quad (4.56)$$

Generating functions of correlation functions are obtained by inserting

$$e^{p u / \Lambda_{N_f}^2 + \tilde{I}(\mathbf{x}) / \Lambda_{N_f}} \quad (4.57)$$

in the path integral. The surface observable leads to a change in the argument of the sum over fluxes (4.50),

$$\mathbf{z} \rightarrow \mathbf{z} + \frac{\mathbf{x}}{2\pi \Lambda_{N_f}} \frac{du}{da}, \quad \bar{\mathbf{z}} \rightarrow \bar{\mathbf{z}}. \quad (4.58)$$

and to analytically continue \mathbf{b} (4.51) to the complex number by setting $\mathbf{b} = (\mathbf{z} - \bar{\mathbf{z}}) / (2i y)$.

The inclusion of the surface observable also gives rise to a contact term [140, 40, 133], which in particular ensures that the u -plane integrand is single-valued. For $0 \leq N_f \leq 3$, the contact term is $\exp(\mathbf{x}^2 G_{N_f})$ with [141, 130, 142]

$$G_{N_f} = -\frac{1}{24 \Lambda_{N_f}^2} E_2 \left(\frac{du}{da} \right)^2 + \frac{1}{3 \Lambda_{N_f}^2} \left(u + \frac{\Lambda_3^2}{64} \delta_{N_f,3} \right), \quad (4.59)$$

while for $N_f = 4$ it is given by [141, 143]

$$G_{N_f=4} = -\frac{1}{24 \Lambda_4^2} E_2 \left(\frac{du}{da} \right)^2 + \frac{u}{3 \Lambda_4^2} E_2(\tau_{UV}) + \frac{1}{18 \Lambda_4^2} \llbracket m_1^2 \rrbracket E_4(\tau_{UV}). \quad (4.60)$$

This expression (4.59) is valid for the theories with N_f arbitrary hypermultiplet masses. The reason for it is the following [141, 19, 90]: G is guaranteed to be \mathcal{Q} -closed and hence locally holomorphic. First, notice that $\frac{\partial F}{\partial \tau_0} = \frac{u}{4}$, where $\Lambda^{4-N_f} =: e^{\pi i \tau_0}$ for the asymptotically free theories ($N_f \leq 3$) and $\tau_0 = \tau_{UV}$ for $N_f = 4$. The real part of the exponential prefactor of Ψ_μ^J can be added to G to give a monodromy-invariant contribution \hat{G} which multiplies the intersection \mathbf{x}^2 . From the action of a duality

transformation on \hat{G} it can be inferred that

$$G_{N_f} = -\frac{4i}{\pi\Lambda_{N_f}^2} \frac{\partial^2 F}{\partial\tau_0^2}. \quad (4.61)$$

The expressions (4.59) follow by direct computation. A more general scheme to fix the contact terms is proposed in [130]. Contact terms can also be derived from the corresponding Whitham hierarchies [144, 142]. In the presence of surface observables, there are additional mixed contact terms $\frac{\partial^2 \mathcal{F}}{\partial\tau_0 \partial m}$ for the external fluxes $\{\mathbf{k}_j\}$ as encountered in [39] for the $\mathcal{N} = 2^*$ theory.

4.4 The u -plane integral

In this section, we set up the u -plane integral schematically given in the introduction 1.2.3, and demonstrate that it is well-defined on the integration domain for any $\boldsymbol{\mu}$ with appropriate background fluxes. The case $\boldsymbol{\mu} = \bar{w}_2(X)/2$ and $\mathbf{k}_j = 0$ was analysed in [40].

4.4.1 Definition of the integrand

As discussed in the previous sections, the u -plane integral on a closed four-manifold X with $(b_1, b_2^+) = (0, 1)$ depends on many parameters. We summarise:

- The scale Λ_{N_f} and masses $\mathbf{m} = (m_1, \dots, m_{N_f})$ of the theory. See Section 4.1 and Chapter 2.
- The magnetic winding numbers n_j , $j = 1, \dots, N_f$. See Section 4.1.1.
- The four-manifold X , in particular its signature $\sigma = \sigma(X)$, Euler characteristic $\chi = \chi(X)$, period point J and intersection form Q . See Section 4.2.1.
- The 't Hooft flux $\boldsymbol{\mu}$, and the external fluxes $\{\mathbf{k}_j\} = (\mathbf{k}_1, \dots, \mathbf{k}_{N_f})$. See Section 4.2.3.
- The fugacities for the point and surface observables p and \mathbf{x} . See Section 4.3.3.

In terms of these parameters, the u -plane path integral reduces to the following finite-dimensional integral over $\mathcal{F}_{N_f}(\mathbf{m})$,

$$\boxed{\Phi_{\boldsymbol{\mu}, \{\mathbf{k}_j\}}^J(p, \mathbf{x}, \mathbf{m}, \Lambda_{N_f}) = \mathcal{K}_{N_f} \int_{\mathcal{F}_{N_f}(\mathbf{m})} d\tau \wedge d\bar{\tau} \nu(\tau; \{\mathbf{k}_j\}) \Psi_{\boldsymbol{\mu}}^J(\tau, \bar{\tau}, \mathbf{z}, \bar{\mathbf{z}}) e^{2pu + \mathbf{x}^2 G_{N_f}}.} \quad (4.62)$$

We summarise the different elements on the rhs:

- \mathcal{K}_{N_f} is an overall normalisation factor. For $N_f = 0$, it is fixed by matching to known Donaldson invariants. Due to $\chi + \sigma = 4$, there is an ambiguity [44]

$$(\mathcal{K}_{N_f}, \alpha, \beta) \sim (\zeta^{-4} \mathcal{K}_{N_f}, \zeta \alpha, \zeta \beta), \quad (4.63)$$

with α and β the u -independent prefactors in (4.54).

- The integration domain $\mathcal{F}_{N_f}(\mathbf{m})$ in (4.62) is crucially the fundamental domain of the effective gauge coupling. As discussed in Chapter 2, this domain requires new aspects compared to integration domains for earlier discussions of u -plane integrals. The evaluation of integrals over $\mathcal{F}_{N_f}(\mathbf{m})$ will be discussed in more detail in Section 4.5.
- ν is the “measure factor” [42, 40, 135, 130, 39]

$$\nu(\tau; \{\mathbf{k}_j\}) = \frac{da}{d\tau} A^\chi B^\sigma \prod_{i,j=1}^{N_f} C_{ij}^{B(\mathbf{k}_i, \mathbf{k}_j)}. \quad (4.64)$$

It combines the topological couplings (4.54) and the couplings to the background fluxes (4.49) with the Jacobian $\frac{da}{d\tau}$ of the change of variables from a to τ .

- The function Ψ_μ^J arises from the sum over $U(1)$ fluxes. It is a Siegel-Narain theta function (4.50) and discussed in detail in Section 4.3.2. The elliptic parameter z of the Siegel-Narain theta function reads

$$\begin{aligned} z &= \frac{\mathbf{x}}{2\pi \Lambda_{N_f}} \frac{du}{da} + \sum_{j=1}^{N_f} v_j \mathbf{k}_j, \\ \bar{z} &= \sum_{j=1}^{N_f} \bar{v}_j \mathbf{k}_j. \end{aligned} \quad (4.65)$$

- Finally, G_{N_f} is the contact term, discussed in more detail in Section 4.3.3.

4.4.2 Monodromy transformations of the integrand

We continue by explicitly verifying that the u -plane integral is single-valued around the singular points of the moduli space. We find that this puts a constraint on the magnetic winding numbers n_j , in addition to the constraints on the background fluxes \mathbf{k}_j discussed in Section 4.2.3.

Monodromy around infinity

Let us determine how the u -plane integrand transforms under the monodromy around infinity. As a function of the effective coupling τ , the measure factor (4.64) is proportional

to $\frac{da}{d\tau} \left(\frac{du}{da}\right)^{\frac{\chi}{2}} \Delta^{\frac{\sigma}{8}}$ times the product over the couplings C_{ij} . We take the monodromy at infinity to be oriented as $u \rightarrow e^{2\pi i}u$ and $a \rightarrow e^{\pi i}a$, as in Section 4.1.2. Then this path also encircles all singularities u_j , which are the roots of the physical discriminant, $\Delta = \prod_{j=1}^{N_f+2}(u - u_j)$. We thus have that $\Delta \rightarrow e^{2\pi i(N_f+2)}\Delta$, and hence

$$\Delta^{\frac{\sigma}{8}} \rightarrow e^{\pi i(N_f+2)\sigma/4} \Delta^{\frac{\sigma}{8}} \quad (4.66)$$

Next, since $u \rightarrow e^{2\pi i}u$ and $a \rightarrow e^{\pi i}a$ we find $\frac{du}{da} \rightarrow e^{\pi i} \frac{du}{da}$, and therefore

$$\left(\frac{du}{da}\right)^{\frac{\chi}{2}} \rightarrow e^{\pi i\chi/2} \left(\frac{du}{da}\right)^{\frac{\chi}{2}}. \quad (4.67)$$

For $\frac{da}{d\tau}$ we have that $a \rightarrow e^{\pi i}a$, while $d\tau \rightarrow d\tau$, and thus

$$\frac{da}{d\tau} \rightarrow -\frac{da}{d\tau}. \quad (4.68)$$

From (4.8) we recall that $w_{ij} \rightarrow w_{ij} + \delta_{ij}$, such that with the definition (4.49) we find $C_{ij} \rightarrow e^{-\pi i\delta_{ij}} C_{ij}$. The couplings C_{ij} transform in the measure factor as

$$\prod_{i,j=1}^{N_f} C_{ij}^{B(\mathbf{k}_i, \mathbf{k}_j)} \rightarrow e^{-\pi i \sum_j \mathbf{k}_j^2} \prod_{i,j=1}^{N_f} C_{ij}^{B(\mathbf{k}_i, \mathbf{k}_j)}. \quad (4.69)$$

Combining (4.66), (4.67), (4.68), (4.69), and using $\chi = 4 - \sigma$, we obtain

$$\nu \rightarrow -e^{\pi i N_f \sigma/4} e^{-\pi i \sum_j \mathbf{k}_j^2} \nu. \quad (4.70)$$

This phase for $\mathbf{k}_j = 0$ can be checked directly by taking q -expansions from the SW curves, for generic masses.

From (4.8) we recall that under the monodromy around infinity $v_j \rightarrow -v_j - n_j$, and thus

$$\mathbf{z} \rightarrow -\mathbf{z} - \sum_{j=1}^{N_f} n_j \mathbf{k}_j. \quad (4.71)$$

For the sum over fluxes we can now deduce using (B.20) that

$$\begin{aligned} & \Psi_{\mu}^J \left(\tau + N_f - 4, -\mathbf{z} - \sum_{j=1}^{N_f} n_j \mathbf{k}_j \right) \\ &= e^{\pi i(N_f-4)(\mu^2 - \mu \cdot K)} \Psi_{\mu}^J \left(\tau, -\mathbf{z} - \sum_{j=1}^{N_f} n_j \mathbf{k}_j + (N_f - 4) \left(\mu - \frac{K}{2} \right) \right), \end{aligned} \quad (4.72)$$

where we suppressed the dependence on the anti-holomorphic parts. Recall from (4.26) that

$$c_1(\mathcal{L}_j) \equiv K - 2\mu \pmod{2L}. \quad (4.73)$$

and as such we can express $\mathbf{k}_j = c_1(\mathcal{L}_j)/2$ as

$$\mathbf{k}_j = \frac{K}{2} - \boldsymbol{\mu} + \boldsymbol{\ell}_j, \quad \boldsymbol{\ell}_j \in L. \quad (4.74)$$

We have then

$$\mathbf{k}_j^2 = \frac{\sigma}{4} - K \cdot \boldsymbol{\mu} + \boldsymbol{\mu}^2 - 2\boldsymbol{\mu} \cdot \boldsymbol{\ell}_j \pmod{2\mathbb{Z}}, \quad (4.75)$$

where we used that K is a characteristic vector of L , and $K^2 = \sigma \pmod{8}$. Using (B.20) and substitution of (4.74) in this expression, (4.72) equals

$$e^{\pi i(N_f-4)(\boldsymbol{\mu}^2 - \boldsymbol{\mu} \cdot K)} \Psi_{\boldsymbol{\mu}}^J \left(\tau, -\mathbf{z} - \sum_{j=1}^{N_f} n_j \boldsymbol{\ell}_j + (N_f - 4 + \sum_j n_j) \left(\boldsymbol{\mu} - \frac{K}{2} \right) \right). \quad (4.76)$$

Our aim is to write this as a phase times $\Psi_{\boldsymbol{\mu}}^J(\tau, \mathbf{z})$. The constraints on the winding numbers should be independent of $\boldsymbol{\mu}$ and \mathbf{k}_j , since the prepotential is. From (B.23), we therefore get the first constraint

$$\sum_j n_j = N_f \pmod{2}. \quad (4.77)$$

Using identity (B.23), $2\boldsymbol{\mu}^2 - K \cdot \boldsymbol{\mu} \in \mathbb{Z}$ and $4(\boldsymbol{\mu} - \frac{K}{2}) \in 2L$, this simplifies to

$$\begin{aligned} & e^{\pi i(N_f-4)(\boldsymbol{\mu}^2 - \boldsymbol{\mu} \cdot K) + 2\pi i \boldsymbol{\mu} \cdot \sum_j n_j \boldsymbol{\ell}_j - 2\pi i(N_f + \sum_j n_j)(\boldsymbol{\mu}^2 - \boldsymbol{\mu} \cdot K/2)} \Psi_{\boldsymbol{\mu}}^J(\tau, -\mathbf{z}) \\ &= -e^{\pi i N_f(\boldsymbol{\mu}^2 - \boldsymbol{\mu} \cdot K) + 2\pi i \boldsymbol{\mu} \cdot \sum_j n_j \boldsymbol{\ell}_j - 2\pi i(N_f + \sum_j n_j)(\boldsymbol{\mu}^2 - \boldsymbol{\mu} \cdot K/2)} \Psi_{\boldsymbol{\mu}}^J(\tau, \mathbf{z}) \\ &= -e^{-\pi i N_f \boldsymbol{\mu}^2 + 2\pi i \boldsymbol{\mu} \cdot \sum_j n_j \boldsymbol{\ell}_j - 2\pi i \sum_j n_j(\boldsymbol{\mu}^2 - \boldsymbol{\mu} \cdot K/2)} \Psi_{\boldsymbol{\mu}}^J(\tau, \mathbf{z}). \end{aligned} \quad (4.78)$$

Finally using (4.75), we can express the phase in terms of \mathbf{k}_j ,

$$\mathbf{M}_{\infty} : \quad \Psi_{\boldsymbol{\mu}}^J(\tau, \mathbf{z}) \rightarrow -e^{-\pi i N_f \boldsymbol{\mu}^2 - \pi i \sum_j n_j(\mathbf{k}_j^2 + \boldsymbol{\mu}^2 - \sigma/4)} \Psi_{\boldsymbol{\mu}}^J(\tau, \mathbf{z}). \quad (4.79)$$

By multiplying (4.70) with (4.79), we find

$$\nu(\tau; \{\mathbf{k}_j\}) \Psi_{\boldsymbol{\mu}}^J(\tau, \mathbf{z}) \rightarrow e^{-\pi i \sum_j (n_j+1) \mathbf{k}_j^2 + \frac{\pi i}{4} \sum_j (\sigma - 4\boldsymbol{\mu}^2)(n_j+1)} \nu(\tau; \{\mathbf{k}_j\}) \Psi_{\boldsymbol{\mu}}^J(\tau, \mathbf{z}). \quad (4.80)$$

Combining (4.32) with (4.21), we have that $4(\mathbf{k}_j + \boldsymbol{\mu})^2 \equiv \sigma \pmod{8}$ for every $j = 1, \dots, N_f$. We insert this into the second exponential of (4.80), such that

$$\mathbf{M}_{\infty} : \quad \nu(\tau; \{\mathbf{k}_j\}) \Psi_{\boldsymbol{\mu}}^J(\tau, \mathbf{z}) \rightarrow e^{2\pi i \boldsymbol{\mu} \cdot \sum_j (n_j+1) \mathbf{k}_j} \nu(\tau; \{\mathbf{k}_j\}) \Psi_{\boldsymbol{\mu}}^J(\tau, \mathbf{z}), \quad (4.81)$$

and the u -plane integrand is invariant under T^{N_f-4} if and only if $\boldsymbol{\mu} \sum_j (n_j + 1) \mathbf{k}_j \in \mathbb{Z}$. Using (4.74) and the fact that K is a characteristic vector of L , we find

$$n_j = 1 \pmod{2} \quad (4.82)$$

for all $j = 1, \dots, N_f$, which implies the above constraint (4.77).

Monodromy around the other singularities

The analogous analysis can be performed for the monodromies around the other singularities, i.e., the mass singularities $a = \frac{m_j}{\sqrt{2}}$, as well as the monopole and dyon singularities. A detailed analysis is performed in [5, Sec. 5] but we omit it here for brevity. The result is that the monodromy around the mass singularities does not impose any new constraints while those around the monopole and dyon points do. We find that for the u -plane integral to be single-valued we need to impose the constraint

$$n_j = -1 \pmod{4}, \quad j = 1, \dots, N_f, \quad (4.83)$$

for the magnetic winding numbers. To see this, we consider the transformation of the Siegel-Narain theta function when going around the monopole point in the $N_f = 1$ theory, (4.12),

$$\begin{aligned} \Psi_{\mu}^J\left(\frac{\tau}{-\tau+1}, \frac{v\mathbf{k}_1+(n+1)/2\tau\mathbf{k}_1}{-\tau+1}\right) &= (-\tau+1)^{b_2/2}(-\bar{\tau}+1)^2 e^{\pi i(n+1)\mathbf{k}_1 \cdot K/2 - (n+1)^2 \mathbf{k}_1^2/4} e^{-\pi i\sigma/4} \\ &\times \exp\left[\pi i \frac{(v+(n+1)/2)^2}{-\tau+1} \mathbf{k}_1^2\right] \Psi_{\mu+(n+1)\mathbf{k}_1/2}^J(\tau, \mathbf{z}). \end{aligned} \quad (4.84)$$

Now, since Ψ_{μ}^J is required to transform to itself up to an overall factor, we must demand that $(n+1)\mathbf{k}_1/2 \in L$. Therefore for $\mathbf{k}_1 \in L/2$, we find the requirement that $n = -1 \in \mathbb{Z}_4$. After incorporating this constraint it is straightforward to show that the phases cancel with the corresponding transformations from the measure factor [5].

4.5 Integration over fundamental domains

As discussed in Sections 4.1 and 4.4, u -plane integrals for massive $\mathcal{N} = 2$ theories with fundamental hypermultiplets include new aspects. This section discusses how to evaluate such integrals (4.62). More concretely, we aim to define and evaluate integrals of the form

$$\mathcal{I}_f = \int_{\mathcal{F}(\mathbf{m})} d\tau \wedge d\bar{\tau} y^{-s} f(\tau, \bar{\tau}), \quad (4.85)$$

with $s \leq 1$. The domain $\mathcal{F}(\mathbf{m})$ is the fundamental domain for the effective coupling constant as discussed in Chapter 2, and f a non-holomorphic function of weight $(2-s, 2-s)$ arising from the topologically twisted Yang-Mills theory. For $\mathcal{F}(\mathbf{m})$ a fundamental domain of a congruence subgroup, such integrals (4.85) have been studied in the context of theta lifts of weakly holomorphic modular forms and harmonic Maass forms [145–147] as well as one-loop amplitudes in string theory [148–150].

We assume that the integrand $y^{-s} f(\tau, \bar{\tau})$ can be expressed as

$$\partial_{\bar{\tau}} \hat{h}(\tau, \bar{\tau}) = y^{-s} f(\tau, \bar{\tau}), \quad (4.86)$$

for a suitable function $\hat{h}(\tau, \bar{\tau})$ using mock modular forms. This was indeed the case in [43, 46, 39, 4], and will be demonstrated for massive $\mathcal{N} = 2$ theories with fundamental hypermultiplets in an upcoming work [117]. In Sec. 4.6 we further show this for the pure theory on non-simply connected four-manifolds, generalising the results of [43, 46]. The integral \mathcal{I}_f then reads

$$\mathcal{I}_f = - \int_{\partial\mathcal{F}(\mathbf{m})} d\tau \hat{h}(\tau, \bar{\tau}), \quad (4.87)$$

with $\partial\mathcal{F}(\mathbf{m})$ the boundary of $\mathcal{F}(\mathbf{m})$.

There are a number of aspects to be addressed in order to evaluate integrals over $\mathcal{F}(\mathbf{m})$:

1. Identifications of boundary components of $\mathcal{F}(\mathbf{m})$ due to monodromies on the u -plane.
2. Contributions from the cusps, that is $\tau \rightarrow i\infty$ or $\tau \rightarrow \gamma(i\infty) \in \mathbb{Q}$ for an element $\gamma \in \text{PSL}(2, \mathbb{Z})$.
3. Contributions from a singular point in the interior of $\mathcal{F}(\mathbf{m})$.
4. Contributions from an elliptic point $p \in \mathbb{H}$ of $\text{PSL}(2, \mathbb{Z})$.
5. Branch points and branch cuts.

We will discuss these aspects 1.–5. in the following.

1. *Identifications*

The modular transformation induced by monodromies identify components of the boundary of the fundamental domain $\partial\mathcal{F}(\mathbf{m})$ pairwise. Their contributions to the integral (4.87) vanish, which is, for example, familiar from deriving valence formulas for modular forms [151, Fig. 2]. See Fig. 1.2 for an example of how the boundaries are identified.

2. *Cusps*

At the cusps, the topological theory is singular due to extra contributions from the supersymmetric configurations of (4.28). The contributions to the integral near the cusps thus require a regularisation [40, 45]. Such regularisations have been developed in the context of string amplitudes [148–150] and analytic number theory [152, 151, 146].

Let us first consider the cusp $\tau \rightarrow i\infty$. To regularise the divergence, one introduces a cut-off $\text{Im } \tau = Y \gg 1$, and takes the limit $Y \rightarrow \infty$ after evaluation. We require that

f near $i\infty$ has a Fourier expansion of the form²

$$f(\tau, \bar{\tau}) = \sum_{m \gg -\infty, n \geq 0} c(m, n) q^m \bar{q}^n. \quad (4.88)$$

Then the function \widehat{h} has the form,

$$\widehat{h}(\tau, \bar{\tau}) = h(\tau) + 2^s \int_{-\bar{\tau}}^{i\infty} \frac{f(\tau, -v)}{(-i(v + \tau))^s} dv, \quad (4.89)$$

where $h(\tau)$ is a weakly holomorphic q -series, with expansion

$$h(\tau) = \sum_{m \gg -\infty} d(m) q^m. \quad (4.90)$$

The cusp $\tau \rightarrow i\infty$ then contributes

$$[\mathcal{I}_f]_\infty = w_\infty d(0), \quad (4.91)$$

with $d(0)$ the constant term of $h(\tau)$ (4.90), and w_∞ the width of the cusp $\mathcal{F}(\mathbf{m})$ at $i\infty$. For $N_f \leq 3$, w_∞ is $4 - N_f$ as we have seen in previous chapters.

The other cusps can be treated in a similar fashion using modular transformations. We label the n_c cusps in $\mathcal{F}(\mathbf{m})$ by $j = 1, \dots, n_c$. If the cusp is on the horizontal axis at $-\frac{d_j}{c_j} \in \mathbb{Q}$ with relative prime $(c_j, d_j) \in \mathbb{Z}^2$, we can map the cusp to $i\infty$ by a modular transformation

$$\gamma_j = \begin{pmatrix} a_j & b_j \\ c_j & d_j \end{pmatrix}. \quad (4.92)$$

We let $\tau_j = \gamma_j \tau$. Then the holomorphic part $h_j(\tau_j)$ of $(c_j \tau + d_j)^{-2} \widehat{h}(\gamma \tau_j, \gamma \bar{\tau}_j)$ can be expanded for τ near $-\frac{d_j}{c_j}$ as

$$h_j(\tau_j) = \sum d_j(n) q_j^n, \quad q_j = e^{2\pi i \tau_j}. \quad (4.93)$$

As a result, the cusp j contributes

$$[\mathcal{I}_f]_j = w_j d_j(0). \quad (4.94)$$

3. Singular points in the interior of $\mathcal{F}(\mathbf{m})$

The integrand can be singular at a point τ_s in the interior of $\mathcal{F}(\mathbf{m})$. Such singularities appear typically for deformations of superconformal theories, such as the $\mathcal{N} = 2^*$ theory and the $N_f = 4$ theory, where the UV coupling τ_{UV} gives rise to such a singularity

²Also if f does not satisfy this requirement, the integral can be regularised as explained in [45, 146]. We do not need this regularisation for the correlators in this thesis.

[39, 3]. See Fig. 2.14 for an example. We require that the expansion of f near such a singularity reads,

$$f(\tau, \bar{\tau}) = \sum_{m \gg -\infty, n \geq 0} c_s(m, n) (\tau - \tau_s)^m (\bar{\tau} - \bar{\tau}_s)^n. \quad (4.95)$$

Then, the anti-derivative $\hat{h}(\tau, \bar{\tau})$ has similar expansion,

$$\hat{h}(\tau, \bar{\tau}) = \sum_{m \gg -\infty, n \geq 0} d_s(m, n) (\tau - \tau_s)^m (\bar{\tau} - \bar{\tau}_s)^n. \quad (4.96)$$

That this holds will be discussed in more detail in the upcoming work [117]. The contour integral for a small contour around τ_s ,

$$C_\varepsilon(\tau_s) = \left\{ \tau = \tau_s + \varepsilon e^{i\varphi}, \varphi \in [0, 2\pi) \right\}, \quad (4.97)$$

is bounded for such a function. Close to the singularity we have

$$\int_\varepsilon^{r_0} r dr \int_0^{2\pi} d\varphi (\tau - \tau_s)^m (\bar{\tau} - \bar{\tau}_s)^n = 2\pi \delta_{m,n} \int_\varepsilon^{r_0} dr r^{2m+1}, \quad (4.98)$$

with $(\tau - \tau_s) = r e^{i\varphi}$. This is convergent for $n \geq 0$ when $\varepsilon \rightarrow 0$ [39]. We define the “residue” of a non-holomorphic function $g(\tau, \bar{\tau})$

$$\text{nRes}_{\tau=\tau_s} [g(\tau, \bar{\tau})] = \frac{1}{2\pi i} \lim_{\varepsilon \rightarrow 0} \oint_{C_\varepsilon(\tau_s)} g(\tau, \bar{\tau}) d\tau. \quad (4.99)$$

The reason why this procedure works, and does not depend on the contour, is due to the fact that the anti-holomorphic dependence is controlled by having $n \geq 0$ in (4.96), as seen above. See also [45] for a more in depth study of the regularisation procedure of these types of integrals. For the expansion (4.95) we then find

$$[\mathcal{I}_f]_s = 2\pi i \text{nRes}_{\tau=\tau_s} [\hat{h}(\tau, \bar{\tau})] = d_s(-1, 0), \quad (4.100)$$

with $d_s(-1, 0)$ the coefficient in the expansion (4.96).

4. Elliptic points

For $\mathcal{N} = 2$ SQCD, AD points are the elliptic points of the duality group, and lie on the boundary of $\mathcal{F}(\mathbf{m})$. See Fig. 2.5 for an example. The elliptic points are $\alpha = e^{\pi i/3}$ and i , and their images under $\text{PSL}(2, \mathbb{Z})$. Contour integrals around such points can be regularised using a cut-off ε . We assume that the anti-derivative \hat{h} has the following expansion near an elliptic point τ_e ,

$$\hat{h}(\tau, \bar{\tau}) = \sum_{m \gg -\infty, n \geq 0} d_e(m, n) (\tau - \tau_e)^m (\bar{\tau} - \bar{\tau}_e)^n. \quad (4.101)$$

As a result, the boundary arc around τ_{AD} in \mathbb{H} is a fraction of 2π , which needs to be properly accounted for. These neighbourhoods have an angle $\frac{2\pi}{k_e}$, with $k_e = 2$ for $\tau_e = i$, and $k_e = 6$ for $\tau_e = \alpha$ [79]. Furthermore, it is important how many images of \mathcal{F} in $\mathcal{F}(\mathbf{m})$ coincide at the elliptic point. We denote this number by n_e . For $\mathcal{N} = 2$ SQCD, we found examples with $n_e = 2$ and 4 for $\tau_e \sim \alpha$, while for $\tau_e \sim i$, $n_e = 1$ [2]. The contribution from an elliptic point is then,

$$[\mathcal{I}_f]_e = 2\pi i \frac{n_e}{k_e} \text{nRes}_{\tau=\tau_e} [\hat{h}(\tau, \bar{\tau})] = \frac{n_e}{k_e} d_e(-1, 0), \quad (4.102)$$

In an upcoming work, [117], we will argue in more detail that the non-holomorphic residue is well-defined for the elliptic points of the theory since the dependence on $\bar{\tau}$ is well behaved.

5. Branch points and cuts

Branch points and cuts are a new aspect compared to previous analyses (see for instance Fig. 2.3). We will demonstrate that their contribution vanishes for the integrands of interest.

We assume that the integrand f satisfies

$$\hat{h}(\tau, \bar{\tau}) = (\tau - \tau_{\text{bp}})^n g(\tau, \bar{\tau}), \quad (4.103)$$

with $n \in \mathbb{Z}/2$ and $n \geq -1/2$, $g(\tau, \bar{\tau})$ being a real analytic function near τ_{bp} . This assumption is satisfied for the twisted Yang-Mills theories [117]. To treat this type of singularity, we remove a δ neighbourhood and analyse the $\delta \rightarrow 0$ limit. Let C_δ be the contour

$$C_\delta = \{\tau_{\text{bp}} + \delta e^{i\theta} \mid \theta \in (0, 2\pi)\} \quad (4.104)$$

around τ_{bp} with radius $\delta > 0$. Therefore, on the contour $|y^{-s} f|$ is bounded by

$$|\hat{h}| \leq \delta^n K \quad (4.105)$$

for some $K > 0$. The integral around the branch point therefore vanishes in the limit,

$$\begin{aligned} \mathcal{I}_f^{\text{bp}} &= \lim_{\delta \rightarrow 0} \int_{C_\delta} \hat{h} |d\tau| \leq \lim_{\delta \rightarrow 0} \int_0^{2\pi} \delta^n K \delta d\theta \\ &= \lim_{\delta \rightarrow 0} 2\pi K \delta^{n+1} = 0. \end{aligned} \quad (4.106)$$

The branch points necessarily give rise to branch cuts. For the purpose of integration, we remove a neighbourhood with distance r from the cut, and take the limit $r \rightarrow 0$ after determining the integral. Since the value of the integrand is finite near the branch cut, the contribution to the integral vanishes.

Summary

Combining all the contributions discussed above, we find

$$\mathcal{I}_f = \sum_{j=1}^n w_j d_j(0) + \sum_s d_s(-1, 0) + \sum_e \frac{n_e}{k_e} d_e(-1, 0). \quad (4.107)$$

This formula generalises [40] for the pure $N_f = 0$ theory on a smooth four-manifold X that admits a metric of positive scalar curvature, [46, Equation (5.10)] for the pure theory on generic X , [39, Equation (4.88)] for the $\mathcal{N} = 2^*$ theory on X , and [153] for the massless $N_f = 2$ and $N_f = 3$ theories on $X = \mathbb{C}\mathbb{P}^2$.

4.6 Non-simply connected manifolds

If we allow for the theory to be placed on a non-simply connected four-manifold, the analysis will be slightly more complicated. The presence of zero modes for the one-forms add many ingredients that were glossed over in the above analysis. Let us now for simplicity turn again to the pure theory but to see how the explicit analysis works out when allowing for four-manifolds that are non-simply connected. This analysis follows closely [4]. The starting point will be the topologically twisted pure theory.

4.6.1 Effective Lagrangian

The low-energy U(1) effective Lagrangian \mathcal{L} of the twisted pure theory, including the one-forms, is given in [40, (2.15)]. For brevity, we do not print it here. The \mathcal{Q} -exact terms as well as the kinetic terms do not contribute since the zero modes are constant in Donaldson-Witten theory on a four-manifold X with $b_2^+(X) = 1$. For such manifolds there is a useful fact stating that for any $\beta_1, \beta_2, \beta_3, \beta_4 \in H^1(X, \mathbb{Z})$, we have [154]

$$\beta_1 \wedge \beta_2 \wedge \beta_3 \wedge \beta_4 = 0. \quad (4.108)$$

We will make extensive use of this below.

Let us define \mathcal{L}' as the part of the zero-mode low-energy U(1) effective Lagrangian that contributes to the u -plane integral. It is given by [40]

$$\begin{aligned} \mathcal{L}' = & \pi i \bar{\tau} \mathbf{k}_+^2 + \pi i \tau \mathbf{k}_-^2 - \frac{y}{8\pi} D \wedge *D + \frac{i\sqrt{2}}{16\pi} \frac{d\bar{\tau}}{d\bar{a}} \eta\chi \wedge (F_+ + D) \\ & - \frac{i\sqrt{2}}{2^7\pi} \frac{d\tau}{da} \psi \wedge \psi \wedge (F_- + D), \end{aligned} \quad (4.109)$$

where $F_{\pm} = 4\pi \mathbf{k}_{\pm}$, as before. Compare with (4.45). In \mathcal{L}' , we disregard any summands in \mathcal{L} containing \mathcal{Q} -exact terms, exact differential forms and \wedge -products of four 1-forms. Here and throughout the rest of the chapter we use units where the dynamical scale Λ_0

of the low-energy effective U(1) theory is equal to one. The gravitational contributions to \mathcal{L}' are described in the following subsection.

4.6.2 Measure factors

Assuming X is connected and allowing for $b_1 \neq 0$, the measure factor of (4.64), for the pure theory, can now be rewritten as [16, 40]

$$\nu(\tau) := - \left(2^{7/2}\pi\right)^{\frac{b_1}{2}} \frac{2^{\frac{3\sigma(X)+1}{4}}}{\pi} (u^2 - 1)^{\frac{\sigma(X)}{8}} \left(\frac{da}{du}\right)^{\frac{\sigma(X)}{2} + b_1 - 2} \frac{da}{d\tau}. \quad (4.110)$$

Here we used $\chi(X) + \sigma(X) = 4 - 2b_1$ to eliminate $\chi(X)$.

The zero modes of the one-forms ψ live in the tangent space of a b_1 -dimensional torus $\mathbb{T}^{b_1} = H^1(X, \mathbb{R})/H^1(X, \mathbb{Z}) = H^1(X, \mathcal{O}_X^*)$ which corresponds to isomorphism classes of invertible sheaves (for X a smooth complex variety that means holomorphic line bundles) on X which are topologically trivial. We can expand ψ in zero-modes as $\psi = \sum_{i=1}^{b_1} c_i \beta_i$ with β_i an integral basis of harmonic one-forms, and c_i Grassmann variables. We then have the measure

$$\prod_{i=1}^{b_1} \frac{dc_i}{\sqrt{y}} = y^{-\frac{b_1}{2}} \prod_{i=1}^{b_1} dc_i. \quad (4.111)$$

The photon partition function, (4.50), will now also include an integration over b_1 zero modes of the gauge field corresponding to flat connections [155]. These zero modes span the tangent space of \mathbb{T}^{b_1} . As a consequence of this, the photon partition function will have an overall factor of $y^{\frac{1}{2}(b_1-1)}$ [42]. Combining this with the measure factor (4.111) we see that the only surviving factor in the end will be $y^{-1/2}$.

We can also consider the c_j in the expansion of ψ as a basis of one-forms $\beta_j^\# \in H^1(\mathbb{T}^{b_1}, \mathbb{Z})$, dual to β_j , such that

$$\psi = \sum_{j=1}^{b_1} \beta_j \otimes \beta_j^\#. \quad (4.112)$$

A useful fact about four-manifolds with $b_2^+ = 1$ is that the image of the map

$$\wedge : H^1(X, \mathbb{Z}) \otimes H^1(X, \mathbb{Z}) \rightarrow H^2(X, \mathbb{Z}) \quad (4.113)$$

is generated by a single rational cohomology class, which we denote as W [154].³ This means that we can write $\beta_i \wedge \beta_j = a_{ij} W$, $i, j = 1, \dots, b_1$, where a_{ij} is an anti-symmetric

³This class is denoted Σ in [155] and Λ in [156]. However, since we want to reserve Σ for the Riemann surfaces studied below and Λ_0 for the dynamical scale of the theory we choose to call the class W .

matrix. This further implies that the two-form on \mathbb{T}^{b_1} can be written as

$$\Omega = \sum_{i < j} a_{ij} \beta_i^\# \wedge \beta_j^\#, \quad (4.114)$$

where $\beta_i^\# \in H^1(\mathbb{T}^{b_1}, \mathbb{Z})$, such that

$$\text{vol}(\mathbb{T}^{b_1}) = \int_{\mathbb{T}^{b_1}} \frac{\Omega^{b_1/2}}{(b_1/2)!}. \quad (4.115)$$

Below, we will study four-manifolds of the type $X = \mathbb{C}\mathbb{P}^1 \times \Sigma_g$ with Σ_g a genus g Riemann surface. For these manifolds we have that $W = [\mathbb{C}\mathbb{P}^1]$ and $\text{vol}(\mathbb{T}^{b_1}) = 1$ [155].

Using the analysis above we can now write $\psi \wedge \psi = 2(W \otimes \Omega)$ [155]. This will be very useful later on when we want to perform the integral over \mathbb{T}^{b_1} for the product ruled surfaces.

4.6.3 Observables

Observables that are \mathcal{Q} -invariant can be constructed using the celebrated descent formalism. By starting with the zero-form operator $\mathcal{O}^{(0)} = 2u$, we find all k -form valued observables $\mathcal{O}^{(k)}$ for $k = 1, 2, 3, 4$ that are \mathcal{Q} -invariant modulo exact forms by solving the descent equations

$$d\mathcal{O}^{(j)} = \{\mathcal{Q}, \mathcal{O}^{(j+1)}\} \quad (4.116)$$

inductively. This ensures that for a k -cycle $\Sigma^{(k)} \in H_k(X)$ in X , the integrals $\int_{\Sigma^{(k)}} \mathcal{O}^{(k)}$ are \mathcal{Q} -invariant and only depend on $\Sigma^{(k)}$. Fortunately, there is a canonical solution to the descent equations: Due to the fact that the translation generator is \mathcal{Q} -exact, there is a one-form valued *descent operator* K , which satisfies $d = \{\mathcal{Q}, K\}$ [40]. This implies that (4.116) can be solved by $\mathcal{O}^{(j)} = K^j \mathcal{O}^{(0)}$, where the iterated (anti)-commutators are implicit.

The action of the operator K can be inferred from the BRST transformations (4.41) as [40]

$$\begin{aligned} [K, a] &= \frac{1}{4\sqrt{2}}\psi, & [K, \bar{a}] &= 0, & [K, \psi] &= -2(F_- + D), & [K, A] &= -2\dot{i}\chi, \\ [K, \eta] &= -\frac{\dot{i}}{\sqrt{2}}d\bar{a}, & [K, \chi] &= -\frac{3\sqrt{2}\dot{i}}{4} * d\bar{a}, & [K, D] &= \frac{3\dot{i}}{4} (2d\chi - *d\eta). \end{aligned} \quad (4.117)$$

Let us study the insertion of all possible observables. For ease of notation, let us denote $p = \Sigma^{(0)}$ a point class, $\gamma = \Sigma^{(1)}$ a 1-cycle, $\mathbf{x} = \Sigma^{(2)}$ a 2-cycle and $Y = \Sigma^{(3)}$ a 3-cycle. The cycles γ , \mathbf{x} and Y can be expanded in formal sums as

$$\gamma = \sum_{i=1}^{b_1} \zeta_i \gamma_i, \quad \mathbf{x} = \sum_{i=1}^{b_2} \lambda_i \mathbf{x}_i, \quad Y = \sum_{i=1}^{b_3} \theta_i Y_i, \quad (4.118)$$

where γ_i , x_i and Y_i are a basis of one-, two- and three-cycles respectively, λ_i are complex numbers, while ζ_i and θ_i are Grassmann variables. By a common abuse of notation, we use the same notation for the 3-, 2-, and 1-forms Poincaré dual to the cycles.

The most general \mathcal{Q} -invariant observable we can add is then

$$I_{\mathcal{O}} = 2pu + a_1 \int_{\gamma} Ku + a_2 \int_x K^2u + a_3 \int_Y K^3u, \quad (4.119)$$

where $a_2 = \frac{i}{\sqrt{2\pi}}$ is fixed from matching with the mathematical literature [40] and

$$\begin{aligned} Ku &= \frac{1}{4\sqrt{2}} \frac{du}{da} \psi, \\ K^2u &= \frac{1}{32} \frac{d^2u}{da^2} \psi \wedge \psi - \frac{\sqrt{2}}{4} \frac{du}{da} (F_- + D), \\ K^3u &= \frac{1}{2^7\sqrt{2}} \frac{d^3u}{da^3} \psi \wedge \psi \wedge \psi - \frac{3}{16} \frac{d^2u}{da^2} \psi \wedge (F_- + D) - \frac{3\sqrt{2}i}{16} \frac{du}{da} (2d\chi - *\eta). \end{aligned} \quad (4.120)$$

4.6.4 Contact terms

The existence of the canonical solution to the descent equations allows to map an observable of the UV theory to the low-energy U(1) effective theory on the u -plane. For instance, the operator $I(\mathbf{x}) = \int_x K^2u$ of the UV theory is mapped to the same observable $\tilde{I}(\mathbf{x}) = \int_x K^2u$ in the IR. This is not quite true for products $I(\mathbf{x}_1)I(\mathbf{x}_2)\dots I(\mathbf{x}_n)$ of such operators for distinct Riemann surfaces $\mathbf{x}_i \in H_2(X, \mathbb{Z})$. At the intersection of the surfaces, contact terms will appear, as in Section 4.3.3, [40, 130]. When mapping a product of surface operators to the IR, the product is corrected by a sum over the intersection points. Due to the \mathcal{Q} -invariance, the inserted operator is holomorphic and the point at which it is inserted is irrelevant.

Such contact terms appear for all cycles in X that can intersect. They have been classified and the corresponding contact terms have been found in [155, Equations (2.8)-(2.12)],

$$\begin{aligned} I_{\cap} &= \int_{\mathbf{x} \cap \mathbf{x}} G + a_{13} \int_{Y \cap \gamma} G + a_{32} \int_{Y \cap x} KG + a_{33} \int_{Y \cap Y} K^2G \\ &+ a_{332} \int_{\mathbf{x} \cap Y \cap Y} \frac{\partial^3 F}{\partial \tau_0^3} + a_{333} \int_{Y \cap Y \cap Y} K \frac{\partial^3 F}{\partial \tau_0^3} + a_{3333} \int_{Y \cap Y \cap Y \cap Y} \frac{\partial^4 F}{\partial \tau_0^4}. \end{aligned} \quad (4.121)$$

As before, τ_0 is the deformation parameter of the prepotential, related to the dynamical scale by $\Lambda_0^4 = e^{\pi i \tau_0}$. The coefficient functions can all be expressed as quasi-modular functions on the u -plane. The contact term for $\mathbf{x} \cap \mathbf{x}$ we already discussed in Sec. 4.3.3. For the pure theory it is given by, (4.59),

$$G = \frac{u}{2} - \frac{a}{4} \frac{du}{da} = \frac{\vartheta_2^4 + \vartheta_3^4 - E_2}{6\vartheta_2^2\vartheta_3^2}. \quad (4.122)$$

As mentioned before, it is related to the prepotential, F , by $G(\tau) = \frac{4}{\pi i} \frac{\partial^2 F}{\partial \tau_0^2}$ [141]. It furthermore satisfies the identities [155]

$$\frac{dG}{da} = \frac{1}{4} \left(\frac{du}{da} - a \frac{d^2 u}{da^2} \right), \quad \frac{d^2 G}{da^2} = -\frac{a}{4} \frac{d^3 u}{da^3}, \quad \frac{\partial^3 F}{\partial \tau_0^3} = -\frac{\pi^2}{2^4} \left(2G - a \frac{dG}{da} \right). \quad (4.123)$$

We can further use the action (4.117) to find the last contact terms

$$\begin{aligned} KG &= \frac{1}{4\sqrt{2}} \frac{dG}{da} \psi, \\ K^2 G &= \frac{1}{32} \frac{d^2 G}{da^2} \psi \wedge \psi - \frac{1}{2\sqrt{2}} \frac{dG}{da} (F_- + D). \end{aligned} \quad (4.124)$$

The intersection constants can be obtained from duality invariance [155]

$$\begin{aligned} a_1 &= \pi^{-\frac{1}{2}} 2^{\frac{3}{4}} e^{-\frac{\pi i}{4}}, & a_3 &= \pi^{-\frac{3}{2}} 2^{\frac{1}{4}} e^{\frac{\pi i}{4}} / 6, \\ a_{13} &= -6\pi^2 a_1 a_3, & a_{32} &= -6\sqrt{2}\pi i a_3, & a_{33} &= -9\pi^2 a_3^2, \\ a_{332} &= -72\sqrt{2}\pi i a_3^2, & a_{333} &= 36\pi^2 i a_3^3, & a_{3333} &= -(6\pi)^3 i a_3^4. \end{aligned} \quad (4.125)$$

Due to the identity (4.108), the two last terms in (4.121) vanish and we can disregard them. Thus, from (4.121) and (4.124) we see that all terms in I_\cap , (4.121), except for one are only integrated over ψ and τ . The remaining term

$$- \frac{\sqrt{2} a_{33}}{4} \frac{dG}{da} B(F_- + D, Y \wedge Y). \quad (4.126)$$

is to be integrated over D , χ and η .

4.6.5 \mathcal{Q} -exact operators

As we discussed in Sec. 4.3.2, the photon path integral combines with the insertion of the surface observable to a Siegel-Narain theta function $\Psi_\mu^J(\tau, z)$. See also Appendix B.2. This function can be expressed as a total derivative to a non-holomorphic modular completion of an indefinite theta function, as has been previously shown in the simply connected case [43, 46] and will be further discussed for the theories with fundamental matter in an upcoming work [117]. To facilitate the calculation further, the authors of [43] added the \mathcal{Q} -exact operator [43, (2.11) and (2.12)]

$$\begin{aligned} I_x &= -\frac{1}{4\pi} \int_x \left\{ \mathcal{Q}, \frac{d\bar{u}}{d\bar{a}} \chi \right\} \\ &= -\frac{\sqrt{2} i}{4\pi} \frac{d^2 \bar{u}}{d\bar{a}^2} \int_x \eta \chi - \frac{i}{4\pi} \frac{d\bar{u}}{d\bar{a}} \int_x (F_+ - D). \end{aligned} \quad (4.127)$$

The u -plane integrand with I_x inserted can also in the case where $b_1 \neq 0$ be written as an anti-holomorphic derivative. However, it does not give the same kind of Siegel-Narain

theta function as in the simply-connected case. The reason is that the putative elliptic argument z of Ψ_μ^J does not couple to $H_-^2(X)$ symmetrically to how its conjugate \bar{z} couples to $H_+^2(X)$. The insertion of I_x in the case $b_1 = 0$ can be viewed as the unique correction to the path integral that symmetrises the couplings to $H_\pm^2(X)$. Without such an insertion, the resulting theta functions are not symmetric, see for instance [40, Equation (3.18)].

It turns out that, to get the non-simply connected theta function to be symmetric, one needs to add the insertion

$$\begin{aligned} I(\mathbf{x}, Y) &:= I_x + I_Y + I_{Y \cap Y} \\ &= -\frac{i}{2} \left(\sqrt{2} B(\eta\chi, \partial_{\bar{a}} \bar{z}) + B(F_+ - D, \bar{z}) \right), \end{aligned} \quad (4.128)$$

where we defined

$$\begin{aligned} z &= \boldsymbol{\rho} + 2i y \omega, & \boldsymbol{\rho} &= \frac{\mathbf{x}}{2\pi} \frac{du}{da}, & \mathbf{b} &= \frac{\text{Im}(\boldsymbol{\rho})}{y} \\ \omega &:= \frac{\sqrt{2}i}{2^7 \pi y} \frac{d\tau}{da} \psi \wedge \psi - \frac{3a_3}{2^4 y} \frac{d^2 u}{da^2} \psi \wedge Y - \frac{\sqrt{2}a_{33}}{4y} \frac{dG}{da} Y \wedge Y, \end{aligned} \quad (4.129)$$

with $y = \text{Im}(\tau)$ and besides I_x we have introduced the \mathcal{Q} -exact insertions

$$\begin{aligned} I_Y &= -\frac{3i\bar{a}_3}{16} \int_Y \left[\mathcal{Q}, \frac{d^2 \bar{u}}{d\bar{a}^2} \chi \wedge \psi \right] + \frac{\sqrt{2}}{2^7 \pi} \int_X \left\{ \mathcal{Q}, \frac{d\bar{\tau}}{d\bar{a}} \chi \wedge \psi \wedge \psi \right\} \\ &= \frac{3\sqrt{2}\bar{a}_3}{2^4} \frac{d^3 \bar{u}}{d\bar{a}^3} B(\eta\chi, \psi \wedge Y) + \frac{3\bar{a}_3}{2^4} \frac{d^2 \bar{u}}{d\bar{a}^2} B(F_+ - D, \psi \wedge Y) \\ &\quad + \frac{i}{2^6 \pi} \frac{d^2 \bar{\tau}}{d\bar{a}^2} B(\eta\chi, \psi \wedge \psi) + \frac{\sqrt{2}i}{2^7 \pi} \frac{d\bar{\tau}}{d\bar{a}} B(F_+ - D, \psi \wedge \psi) \end{aligned} \quad (4.130)$$

and

$$\begin{aligned} I_{Y \cap Y} &= -\frac{\sqrt{2}i\bar{a}_{33}}{4} \int_{Y \cap Y} \left\{ \mathcal{Q}, \frac{d\bar{G}}{d\bar{a}} \chi \right\} \\ &= \frac{\bar{a}_{33}}{2} \frac{d^2 \bar{G}}{d\bar{a}^2} B(\eta\chi, Y \wedge Y) + \frac{\sqrt{2}\bar{a}_{33}}{4} \frac{d\bar{G}}{d\bar{a}} B(F_+ - D, Y \wedge Y). \end{aligned} \quad (4.131)$$

It is clear that $I(\mathbf{x}, Y)$ is purely anti-holomorphic. The operator $I(\mathbf{x}, Y)$ is then included into the path integral. The addition of such \mathcal{Q} -exact operators to the u -plane integral has been shown to not alter the end result [45]. See also [4, App. B].

4.6.6 The u -plane integral for $\pi_1(X) \neq 0$

The u -plane integral can now be expressed as

$$Z_u(p, \gamma, \mathbf{x}, Y) = \int d\tau \wedge d\bar{\tau} \int [d\eta d\chi dD] \int_{\text{Pic}(X)} d\psi \frac{d\bar{a}}{d\bar{\tau}} \nu(\tau) \frac{1}{\sqrt{y}} e^{-\int_X \mathcal{L}' + I_{\mathcal{O}} + I_{\Gamma} + I(\mathbf{x}, Y)}, \quad (4.132)$$

where $\int_{\text{Pic}(X)}$ denotes a sum over isomorphism classes of line bundles, equivalent to a sum over $H^2(X, \mathbb{Z})$, followed by an integration over \mathbb{T}^{b_1} and the factor of $\frac{d\bar{a}}{d\bar{\tau}}$ comes from the fact that we have changed integration variables from a, \bar{a} to $\tau, \bar{\tau}$ as discussed in the previous sections. The ψ zero modes are tangent to $\text{Pic}(X)$, so the integral over these modes is understood as the integral of a differential form on $\text{Pic}(X)$ [40]. At this point let us make a remark. The \mathcal{Q} -exact operator $I(\mathbf{x}, Y)$ is not strictly required in order to derive our end result (4.144). As a matter of fact, as shown in [46] this operator can be added freely as $\alpha I(\mathbf{x}, Y)$, with α any number.⁴ However, the case of $\alpha = 1$ makes the analysis simpler and more elegant.

Let us perform the integrals above in steps, using an economical notation. Just as in Sec. 4.3, We integrate first over the auxiliary field D , and then over the fermionic 0- and 2-forms, η and χ .

Integration over D , η and χ

Using (4.129), we can expand the terms in the exponential of (4.132) that are affected by the integrals over D , η and χ as (ignoring the remaining terms for now)

$$\begin{aligned} & - \int_X (\mathcal{L}' + a_2 K^2 u + a_3 K^3 u) + I(\mathbf{x}, Y) - \frac{\sqrt{2} a_{33}}{4} \frac{dG}{da} B(F_- + D, Y \wedge Y) \\ & = -\pi i \bar{\tau} \mathbf{k}_+^2 - \pi i \tau \mathbf{k}_-^2 + \frac{y}{8\pi} D^2 - \frac{\sqrt{2} i d\bar{\tau}}{4 d\bar{a}} B(\eta\chi, \mathbf{k}_+) - \frac{\sqrt{2} i d\bar{\tau}}{16\pi d\bar{a}} B(\eta\chi, D) \\ & - \frac{i}{\sqrt{2}} B(\eta\chi, \frac{d\bar{\rho}}{d\bar{a}}) - 2\pi i B(\mathbf{k}_-, \boldsymbol{\rho}) - 2\pi i B(\mathbf{k}_+, \bar{\boldsymbol{\rho}}) + yB(D, b_+) + \frac{\sqrt{2} i}{2^5} B(\psi \wedge \psi, \frac{d\rho}{da}) \\ & - \sqrt{2} \eta B(\chi, \partial_{\bar{a}}(y\bar{\omega})) + 4\pi y B(\mathbf{k}_-, \omega_-) - 4\pi y B(\mathbf{k}_+, \bar{\omega}) + yB(D, \omega_+) + yB(D, \bar{\omega}_+). \end{aligned} \quad (4.133)$$

At any point we discard terms that vanish identically, such as 4-fermion terms or any instance of (4.108) such as $\psi \wedge \psi \wedge \psi \wedge \psi$, $\psi \wedge \psi \wedge \psi \wedge Y$ or $\omega \wedge \omega$. The exponential (4.133) is Gaussian in D with saddle point

$$D = \frac{\sqrt{2} i d\bar{\tau}}{4y} \eta\chi - 4\pi(\mathbf{b}_+ + \omega_+ + \bar{\omega}_+). \quad (4.134)$$

⁴In particular, we can have $\alpha = 0$.

This can be found by differentiating (4.133) with respect to D and setting it to zero. Inserting D in (4.133) gives

$$\begin{aligned}
& + \frac{\sqrt{2}i}{2^5} B(\psi \wedge \psi, \frac{d\rho}{da}) - 2\pi y(\mathbf{b}_+ + \omega_+ + \bar{\omega}_+)^2 - \pi i \bar{\tau} \mathbf{k}_+^2 - \pi i \tau \mathbf{k}_-^2 \\
& - 2\pi i B(\mathbf{k}_-, \boldsymbol{\rho}) - 2\pi i B(\mathbf{k}_+, \bar{\boldsymbol{\rho}}) + 4\pi y B(\mathbf{k}_-, \omega) - 4\pi y B(\mathbf{k}_+, \bar{\omega}) \\
& - \frac{\sqrt{2}i}{4} \frac{d\bar{\tau}}{d\bar{a}} B(\eta\chi, \mathbf{k}_+ - \mathbf{b}_+ - \omega_+ - \bar{\omega}_+) - \frac{i}{\sqrt{2}} B(\eta\chi, \frac{d\bar{\rho}_{\pm}}{d\bar{a}}) - \sqrt{2}\eta B(\chi, \partial_{\bar{a}}(y\bar{\omega})).
\end{aligned} \tag{4.135}$$

The third line gives the only terms involving η and χ , which we will integrate over next. To this end, we combine those terms in the expression

$$- \frac{\sqrt{2}i}{4} \frac{d\bar{\tau}}{d\bar{a}} B(\eta\chi, \mathbf{k} - \mathbf{b} - \omega + \bar{\omega} - 4iy\partial_{\bar{\tau}}\bar{\omega} + 2\partial_{\bar{\tau}}\bar{\boldsymbol{\rho}}). \tag{4.136}$$

Integrating over η and χ , we can rewrite this in a compact way as a total anti-holomorphic derivative times an overall factor that cancels with contributions from the rest of the measure,

$$\frac{\sqrt{2}i}{4} \frac{d\bar{\tau}}{d\bar{a}} B(\mathbf{k} - \mathbf{b} - \omega + \bar{\omega} - 4iy\partial_{\bar{\tau}}\bar{\omega} + 2\partial_{\bar{\tau}}\bar{\boldsymbol{\rho}}, \underline{J}) = \sqrt{y} \frac{d\bar{\tau}}{d\bar{a}} \partial_{\bar{\tau}} \sqrt{2y} B(\mathbf{k} + \mathbf{b} + \omega + \bar{\omega}, \underline{J}), \tag{4.137}$$

where $\partial_{\bar{\tau}}$ acts on everything to its right and $\underline{J} = J/\sqrt{Q(J)} \in H_+^2(X)$ is the normalised self-dual harmonic form on X , called simply J in the previous Sections. This result follows directly from the identities

$$\partial_{\bar{\tau}} y = \frac{i}{2}, \quad \partial_{\bar{\tau}} \sqrt{2y} = \frac{\sqrt{2}i}{4\sqrt{y}}, \quad \partial_{\bar{\tau}} \frac{1}{y} = \frac{1}{2iy^2}, \quad \partial_{\bar{\tau}} \mathbf{b} = \frac{\mathbf{b} - \partial_{\bar{\tau}} \bar{\boldsymbol{\rho}}}{2iy}, \quad \partial_{\bar{\tau}} \omega = \frac{1}{2iy} \omega. \tag{4.138}$$

As previously discussed, the photon path integral together with the measure for the zero modes of ψ contains a sum over all fluxes times a factor of $1/\sqrt{y}$, and additionally contributes $(-1)^{B(k,K)}$, where K is the canonical class of X [42]. The $1/\sqrt{y}$ factor is thus absorbed by the \sqrt{y} on the rhs of (4.137). The factor of $\frac{d\bar{\tau}}{d\bar{a}}$ is cancelled against the inverse factor in (4.132).

Siegel-Narain theta function

Let us demonstrate that the u -plane integrand for $\pi_1(X) \neq 0$, as in the simply-connected case [43], evaluates to a Siegel-Narain theta function. See also Sec. 4.3. To this end, let us define

$$\begin{aligned}
\Psi_{\mu}^J(\tau, \mathbf{z}) &= e^{-2\pi y \beta_+^2} \sum_{\mathbf{k} \in L + \mu} \partial_{\bar{\tau}} \left(\sqrt{2y} B(\mathbf{k} + \boldsymbol{\beta}, \underline{J}) \right) \\
&\times (-1)^{B(\mathbf{k}, K)} q^{-\mathbf{k}_-^2/2} \bar{q}^{\mathbf{k}_+^2/2} e^{-2\pi i B(\mathbf{z}, \mathbf{k}_-) - 2\pi i B(\bar{\mathbf{z}}, \mathbf{k}_+)}
\end{aligned} \tag{4.139}$$

with $q = e^{2\pi i \tau}$ and $\beta = \frac{\text{Im}z}{y} \in L \otimes \mathbb{R}$, where $L = H^2(X, \mathbb{Z})$.

For the elliptic variable $z = \rho + 2iy\omega$, we have $\beta = \mathbf{b} + \omega + \bar{\omega}$ (here, we use that $y\omega$ is holomorphic). Both variables appear naturally in (4.135) and (4.137). In fact, we can combine everything to find

$$Z_u(p, \gamma, \mathbf{x}, Y) = \int_{\Gamma^0(4)\backslash\mathbb{H}} d\tau \wedge d\bar{\tau} \int_{\mathbb{T}^{b_1}} [d\psi] \nu \Psi_\mu^J(\tau, \rho + 2iy\omega) e^{I'_\mathcal{O} + I'_\mathcal{H}}. \quad (4.140)$$

Here,

$$I'_\mathcal{H} = \int_{\mathbf{x} \cap \mathbf{x}} G + a_{13} \int_{Y \cap \gamma} G + a_{332} \int_{\mathbf{x} \cap Y \cap Y} \frac{\partial^3 \mathcal{F}}{\partial \tau_0^3} + \frac{a_{32}}{4\sqrt{2}} \frac{dG}{da} \int_{Y \cap \mathbf{x}} \psi \quad (4.141)$$

and

$$I'_\mathcal{O} = 2pu + \frac{\sqrt{2}a_1}{8} \frac{du}{da} \int_\gamma \psi + \frac{\sqrt{2}i}{26\pi} \frac{d^2u}{da^2} \int_{\mathbf{x}} \psi \wedge \psi, \quad (4.142)$$

are the (holomorphic) remainders of the collections of 0, ..., 3-form observables and their contact terms that has not yet been integrated over, and we eliminated all terms that do not contribute.

Let us check that (4.140) is indeed true from the computations in Section 4.6.6. Aside from the $\psi \wedge \psi$ term, the exponential of the first two lines in (4.135) immediately combine into the definition (4.139) with said parameters, $z = \rho + 2iy\omega$ and $\bar{z} = \bar{\rho} - 2iy\bar{\omega}$. Everything not exponentiated is given by the $\bar{\tau}$ derivative term in (4.137), which precisely gives the derivative term in (4.139). This proves (4.140).

The expression (4.140) generalises the result of the u -plane integral [46, (4.32)] to four-manifolds X with $b_1(X) > 0$ by giving a decomposition of the integrand into a holomorphic and metric-independent measure $\nu e^{I'_\mathcal{O} + I'_\mathcal{H}}$ and a metric-dependent, non-holomorphic component $\Psi_\mu^J(\tau, z)$. Therefore, the evaluation techniques of [46] apply. Namely, we can express the integrand of the u -plane integral as an anti-holomorphic derivative,

$$\frac{d}{d\bar{\tau}} \widehat{\mathcal{H}}_\mu^J(\tau, \bar{\tau}) = \nu \Psi_\mu^J(\tau, z) e^{I'_\mathcal{O} + I'_\mathcal{H}}. \quad (4.143)$$

The holomorphic exponential $e^{I'_\mathcal{O} + I'_\mathcal{H}}$ does not affect the anti-holomorphic derivative, and thus the extension to $\pi_1(X) \neq 0$ is simply through the elliptic argument $z = \rho + 2iy\omega$.

Once $\widehat{\mathcal{H}}_\mu^J(\tau, \bar{\tau})$ is found, we can use coset representatives of $\text{SL}(2, \mathbb{Z})/\Gamma^0(4)$ to map the six images of $\mathcal{F} = \text{SL}(2, \mathbb{Z})\backslash\mathbb{H}$ back to \mathcal{F} (see Fig. 1.2). The regularisation and renormalisation of such integrals originating from insertions of \mathcal{Q} -exact operators has been rigorously established in [45]. As in Sec. 4.5, this then allows to evaluate the partition function as

$$Z_u(p, \gamma, S, Y) = 4\mathcal{I}_\mu(\tau) \Big|_{q^0} + \mathcal{I}_\mu(-\frac{1}{\tau}) \Big|_{q^0} + \mathcal{I}_\mu\left(\frac{2\tau-1}{\tau}\right) \Big|_{q^0}, \quad (4.144)$$

where by $|_{q^0}$ we denote the q^0 coefficient of the resulting Fourier expansion, and the τ -integrand of (4.140) is given by ⁵

$$\mathcal{I}_\mu(\tau) = \int_{\mathbb{T}^{b_1}} [d\psi] \widehat{\mathcal{H}}_\mu^J(\tau, \bar{\tau}). \tag{4.145}$$

The prefactors in (4.144) can be recognised as the widths of the cusps $i\infty$, 0 and 2 of the modular curve $\Gamma^0(4)\backslash\mathbb{H}$.

To derive a suitable anti-derivative $\widehat{\mathcal{H}}_\mu^J(\tau, \bar{\tau})$, it is auxiliary to choose a convenient period point J . The u -plane integral for a different choice J' is then related to the one for J by a wall-crossing formula, given explicitly in [155]. It is shown in [46] that for convenient choices of J , $\Psi_\mu^J(\tau, \mathbf{z})$ factors into holomorphic and anti-holomorphic terms, and the anti-derivative $\widehat{\mathcal{H}}_\mu^J$ can be found for both L even and odd. Furthermore, the u -plane integral can be evaluated using mock modular forms for point observables $p \in H_0(X)$ and Appell-Lerch sums for surface observables $\mathbf{x} \in H_2(X)$ [46].

In [45] it is furthermore shown that in the above mentioned renormalisation, any \mathcal{Q} -exact operator (such as $I(\mathbf{x}, Y)$) decouples in DW theory. However, it is clear that the insertion of $I(\mathbf{x}, Y)$ crucially changes the *integrand*, making the Siegel-Narain theta function symmetric. Instead of inserting $I(\mathbf{x}, Y)$, we can contemplate adding $\alpha I(\mathbf{x}, Y)$ for an arbitrary constant α . It was noticed in [46] that the Siegel-Narain theta function $\Psi_{\mu,\alpha}^J$ for $b_1 = 0$ with the insertion αI_x remains finite at weak coupling ($\text{Im}\tau \rightarrow \infty$) if and only if $\alpha = 1$. This can be seen from the exponential prefactor in (4.139), whose exponent is negative definite if and only if $\bar{\mathbf{z}}$ (which we suppress in the notation) is the complex conjugate of \mathbf{z} .

Single-valuedness

Similar to the analysis in Section 4.4.2 we need to make sure that the u -plane integral is single-valued. This is straightforward, but tedious, and we leave the detailed analysis for the interested reader to look up in [4]. The results are collected in Table 4.1.

object	$d\tau \wedge d\bar{\tau}$	$\int_{\mathbb{T}^{b_1}} [d\psi]$	ν	$\Psi_\mu^J(\tau, z)$	$e^{J'_{\mathcal{O}} + I_{\mathcal{O}}}$	\mathcal{J}_μ^J
weight	$(-2, -2)$	$(-b_1, 0)$	$(2 - \frac{b_2}{2} + b_1, 0)$	$(\frac{b_2}{2}, 2)$	$(0, 0)$	$(0, 0)$
T^4	1	1	-1	-1	1	1
$S^{-1}T^{-1}S$	1	1	$e^{-\frac{\pi i \sigma}{4}}$	$e^{\frac{\pi i \sigma}{4}} e^{-\frac{\pi i \mathbf{z}^2}{\tau+1}}$	$e^{\frac{\pi i \mathbf{z}^2}{\tau+1}}$	1

Table 4.1 Modular weights and phases of the u -plane integrand under $\Gamma^0(4)$ transformations. This proves that the u -plane integrand $\mathcal{J}_\mu^J(\tau)$ transforms trivially, $\mathcal{J}_\mu^J(\gamma\tau) = \mathcal{J}_\mu^J(\tau)$ for any $\gamma \in \Gamma^0(4)$.

⁵One could also contemplate switching the order of integration, and integrate over ψ first. This would however not necessarily result in a function similar to (4.144), and it might not be possible to use the results of [46].

4.6.7 Computation for product ruled surfaces

As an interesting application of our results we can study the u -plane integral for a four-manifold of the type $X = \mathbb{C}\mathbb{P}^1 \times \Sigma_g$, where Σ_g is a genus g Riemann surface. This is a product ruled surface with $b_2^+(X) = 1$.⁶ The DW theory for these manifolds was worked out in [155, 156] and we can use these results as a check of our formula. By shrinking the size of the Riemann surface Σ_g we get a topological σ -model, more specifically the topological A-model, on $\mathbb{C}\mathbb{P}^1$ [157]. By calculating certain correlation functions on both sides we can make an indirect connection between mock modular forms and the topological σ -model on $\mathbb{C}\mathbb{P}^1$. We do not investigate this further in the thesis, but see the discussion in [4, Sec. 5].

The product ruled surfaces that we consider have $b_1 = 2g$, $b_2 = 2$, $b_2^+ = 1$, $K_X = 0$, which in turn means that $\sigma = 0$ and $\chi = 4(1 - g)$ [155]. We consider a general period point

$$J(\theta) = \frac{1}{\sqrt{2}} \left(e^\theta [\mathbb{C}\mathbb{P}^1] + e^{-\theta} [\Sigma_g] \right), \quad (4.146)$$

where $[\mathbb{C}\mathbb{P}^1]$ and $[\Sigma_g]$ are the cohomology classes that generate $H^2(X, \mathbb{Z})$ [155].⁷ For these manifolds we further have that the rational cohomology class W , discussed in Sec. 4.6.2, is simply given by $W = [\mathbb{C}\mathbb{P}^1]$ [154]. The intersection matrix is

$$Q = \begin{pmatrix} 0 & 1 \\ 1 & 0 \end{pmatrix}, \quad (4.147)$$

such that indeed $J(\theta)^2 = 1$. Natural representatives of $[\mathbb{C}\mathbb{P}^1]$ and $[\Sigma_g]$ are found by choosing coordinates $z \in \mathbb{C}$ for $[\mathbb{C}\mathbb{P}^1]$ and representing $[\Sigma_g]$ (for $g > 1$) as a quotient of the Poincaré disk, $\mathcal{D} = \{w : |w| < 1\}$ with a Fuchsian group. This gives [155]

$$\begin{aligned} [\mathbb{C}\mathbb{P}^1] &= \frac{i}{2\pi} \frac{dz \wedge d\bar{z}}{(1 + |z|^2)^2}, \\ [\Sigma_g] &= \frac{i}{2\pi(g-1)} \frac{dw \wedge d\bar{w}}{(1 - |w|^2)^2}. \end{aligned} \quad (4.148)$$

The scalar curvature for this metric is $8\pi(e^\theta - e^{-\theta}(g-1))$. We see that this is positive for $e^{2\theta} > g-1$, such that we do not get any contributions from the Seiberg-Witten invariants in these chambers. In particular, this is true when the volume of $\mathbb{C}\mathbb{P}^1$ is small, since this has θ large and positive.

The connection to the topological σ -model is made in the chamber where we shrink the volume of Σ_g [157]. For completeness, we will calculate the u -plane integral in both

⁶One could alternatively consider products $\Sigma_g \times \Sigma_h$ of Riemann surfaces, however those have $b_2^+ = 1$ if and only if either $g = 0$ or $h = 0$, such that for $g, h \geq 1$ the u -plane integral vanishes.

⁷Sometimes we will be sloppy and write simply $\mathbb{C}\mathbb{P}^1$ and Σ_g for these classes, and hope that this does not confuse the reader.

chambers, where either of the factors shrink. The calculations are similar in both cases and we will start with the chamber where the volume of \mathbb{CP}^1 is small.

From Eq. (4.110) we find that the measure factor for these manifolds simplifies to

$$\nu = -\frac{2}{\pi}(2^{7/2}\pi)^g \left(\frac{da}{du}\right)^{2(g-1)} \frac{da}{d\tau}. \quad (4.149)$$

As we discussed above, we further have that the Ψ_μ^J of (4.140) can be written as a total derivative

$$\Psi_\mu^J(\tau, \mathbf{z}) = \partial_{\bar{\tau}} \widehat{\Theta}_\mu^{JJ'}(\tau, \mathbf{z}), \quad (4.150)$$

where for these manifolds we can take $\widehat{\Theta}_\mu^{JJ'}$ as the indefinite theta function [158]

$$\begin{aligned} \widehat{\Theta}_\mu^{JJ'}(\tau, \mathbf{z}) &= \sum_{\mathbf{k} \in L + \mu} \frac{1}{2} \left[E(\sqrt{2y}B(\mathbf{k} + \boldsymbol{\beta}, \underline{J})) - \text{sgn}(\sqrt{2y}B(\mathbf{k} + \boldsymbol{\beta}, J')) \right] \\ &\times (-1)^{B(\mathbf{k}, K)} q^{-\mathbf{k}^2/2} e^{-2\pi i B(\mathbf{z}, \mathbf{k})}, \end{aligned} \quad (4.151)$$

where $\mathbf{k}^2 = \mathbf{k}_+^2 + \mathbf{k}_-^2$, J' is a reference vector lying in the negative cone such that $Q(J') < 0$,⁸ and

$$E: \mathbb{R} \rightarrow (-1, 1), \quad t \mapsto 2 \int_0^t e^{-\pi x^2} dx \quad (4.152)$$

is a reparametrisation of the error function. See also Appendix B.3 for more details on these indefinite theta functions. This means that we can take as $\widehat{\mathcal{H}}_\mu^J(\tau, \bar{\tau})$ in (4.145)

$$\widehat{\mathcal{H}}_\mu^J(\tau, \bar{\tau}) = \nu \widehat{\Theta}_\mu^{JJ'}(\tau, \mathbf{z}) e^{I'_\sigma + I'_\gamma}. \quad (4.153)$$

For the evaluation of the u -plane integral using this $\widehat{\mathcal{H}}_\mu^J$, one may replace $\widehat{\Theta}_\mu^{JJ'}$ in (4.153) after the modular transformations as in (4.144) with the mock modular form $\Theta_\mu^{JJ'}$ defined in Appendix B.3. This is also in line with the approach in [43].

Shrinking \mathbb{CP}^1

Let us start by analysing the chamber where the volume of \mathbb{CP}^1 is small. In this chamber we fix the primitive null vector to be $J' = [\mathbb{CP}^1] = W$. Due to (4.147), with this choice we have that $B(\psi \wedge \psi, J') = 0$. As above, we denote $\mathbf{z} = \boldsymbol{\rho} + 2i y \omega$ and $\boldsymbol{\beta} = \mathbf{b} + \omega + \bar{\omega}$. We can introduce the split $\mathbf{k} = \mathbf{m} + nW$, with \mathbf{m} chosen such that

$$\frac{B(\mathbf{m} + \boldsymbol{\beta}, J)}{B(W, J)} \in [0, 1). \quad (4.154)$$

⁸The reason for picking J' in the negative cone is to assure that it does not contribute to Eq. (4.150). Had we picked J in the positive cone, we would end up with the wall-crossing contributions from the chambers where J and J' live respectively.

With this split the mock modular form $\Theta_\mu^{JJ'}$ coming from (4.153) can be written as

$$\begin{aligned} \Theta_\mu^{JW}(\tau, z) &= \sum_{n \in \mathbb{Z}} \sum_{\substack{\mathbf{m} \in L + \mu \\ \frac{B(\mathbf{m} + \beta, J)}{B(W, J)} \in [0, 1)}} q^{-\frac{m^2}{2}} e^{-2\pi i B(\mathbf{z}, \mathbf{m})} q^{-nB(W, \mathbf{m})} e^{-2\pi i nB(\rho, W)} \\ &\quad \times \frac{1}{2} \left[\operatorname{sgn} \left(\sqrt{2y} (B(\mathbf{m} + \beta, J) + nB(W, J)) \right) - \operatorname{sgn} \left(\sqrt{2y} B(\mathbf{m} + \beta, W) \right) \right] \\ &= \sum_{\substack{\mathbf{m} \in L + \mu \\ \frac{B(\mathbf{m} + \mathbf{b}, J)}{B(W, J)} \in [0, 1)}} \frac{q^{-\frac{m^2}{2}} e^{-2\pi i B(\mathbf{z}, \mathbf{m})}}{1 - q^{-B(W, \mathbf{m})} e^{-2\pi i B(\rho, W)}}, \end{aligned} \quad (4.155)$$

where, in the second equality, we performed the sum over n . This is an Appell-Lerch sum [158]. The u -plane vanishes in chambers where $w_2(E) \cdot [\mathbb{CP}^1] \neq 0$ [40]. This means that we only have solutions for $w_2(E) = 0$ or $w_2(E) = W$, implying that $B(\mu, W) \in \mathbb{Z}$. The only solutions for the conditions on \mathbf{m} are then $\mathbf{m} = 0$ for $w_2(E) = 0$ and $\mathbf{m} = \frac{1}{2}W$ for $w_2(E) = W$, this means that the contributions from the theta function are

$$\begin{aligned} \Theta_0^{JW}(\tau, \mathbf{z}) &= \frac{1}{1 - e^{-2\pi i B(\rho, W)}}, \\ \Theta_W^{JW}(\tau, \mathbf{z}) &= - \frac{e^{-\pi i B(\rho, W)}}{1 - e^{-2\pi i B(\rho, W)}}. \end{aligned} \quad (4.156)$$

We note that these are independent of ψ . The u -plane integral in this chamber can now be written as

$$Z_{u, \mu}(p, \gamma, \mathbf{x}, Y) = 4 \left[\left(\int_{\mathbb{T}^{b_1}} [d\psi] e^{I'_\sigma + I'_\gamma} \right) \nu \Theta_\mu^{JW}(\tau, \rho) \right]_{q^0}, \quad (4.157)$$

with Θ_μ^{JW} as above. If we only include point and surface observables it is straightforward to do the integral over the torus. The final result is

$$Z_{u, \mu}(p, \mathbf{x}) = \begin{cases} 4 \left[\left(\frac{\sqrt{2} i}{2^{5\pi}} \frac{d^2 u}{da^2} s \right)^g e^{2pu + 2stG} \nu \frac{1}{1 - e^{-i \frac{du}{da} s}} \right]_{q^0}, & \text{for } \mu = 0, \\ -4 \left[\left(\frac{\sqrt{2} i}{2^{5\pi}} \frac{d^2 u}{da^2} s \right)^g e^{2pu + 2stG} \nu \frac{e^{-\frac{i}{2} \frac{du}{da} s}}{1 - e^{-i \frac{du}{da} s}} \right]_{q^0}, & \text{for } \mu = W, \end{cases} \quad (4.158)$$

where we also defined $\mathbf{x} = s[\Sigma_g] + t[\mathbb{CP}^1]$.⁹

Shrinking Σ_g

We now go on to discuss the chamber where we instead shrink the volume of Σ_g . For this chamber we pick the primitive null vector to be $J' = [\Sigma_g]$. The procedure is similar to the above. However, note that now $B(\psi \wedge \psi, J') \neq 0$. We start as before by splitting

⁹There is a small discrepancy between this result and that of [155], namely they differ by an overall phase i^g . This is most likely due to a known discrepancy in the literature for the normalisation of ψ .

$\mathbf{k} = \mathbf{m} + n\Sigma_g$ with \mathbf{m} now chosen such that

$$\frac{B(\mathbf{m} + \beta, J)}{B(\Sigma_g, J)} \in [0, 1). \quad (4.159)$$

Let us start by looking at the contribution from infinity. After performing the sum over n we find that the indefinite theta function becomes

$$\Theta^{J, [\Sigma_g]}(\tau, z) = \sum_{\substack{\mathbf{m} \in L + \mu \\ \frac{B(\mathbf{m} + \beta, J)}{B(\Sigma_g, J)} \in [0, 1)}} \frac{q^{-\mathbf{m}^2/2} e^{-2\pi i B(z, \mathbf{m})}}{1 - q^{-B(\Sigma_g, \mathbf{m})} e^{-2\pi i B(z, \Sigma_g)}}. \quad (4.160)$$

This is again an Appell-Lerch sum [158]. Following [156] we now pick $\omega_2(E) = [\mathbb{C}\mathbb{P}^1] + \epsilon[\Sigma_g]$, with $\epsilon = 0, 1$. For this flux there is no contribution from infinity, as can be seen from the above by realising that there are now no solutions to the conditions on \mathbf{m} . We therefore turn to the other cusps.

For the monopole cusp at $\tau = 0$ we can use the formulas in Appendix B.3 to define the dual indefinite theta function as

$$\Theta_{\mu, D}^{J, [\Sigma_g]}(\tau_D, \mathbf{z}_D) := \tau^{-1} e^{\pi i \frac{\mathbf{z}_D^2}{\tau_D}} \Theta_{\mu}^{J, [\Sigma_g]}(-1/\tau, \mathbf{z}/\tau) = \Theta_0^{J, [\Sigma_g]}(\tau_D, \mathbf{z}_D - \mu, \bar{\mathbf{z}} - \mu), \quad (4.161)$$

where we used that $K_X = 0$ and $b_2(X) = 2$ together with the transformation formulas of the appendix. Following the procedure from above, splitting and summing over n , and simplifying by only including point and surface observables, we eventually find that

$$\begin{aligned} \Theta_0^{J, [\Sigma_g]}(\tau_D, \mathbf{z}_D - \mu, \bar{\mathbf{z}}_D - \mu) &= \frac{1}{1 - e^{-2\pi i B(\mathbf{z}_D - \mu, \Sigma_g)}} \\ &= \left(1 + \exp \left[-2\pi i \left(B(\boldsymbol{\rho}_D, \Sigma_g) - \frac{\sqrt{2}}{2^5 \pi} \left(\frac{d\tau}{da} \right)_D \Omega \right) \right] \right)^{-1}. \end{aligned} \quad (4.162)$$

Here we have used that $B(\mu, \Sigma_g) = \frac{1}{2}$ and that $\psi \wedge \psi = 2W \otimes \Omega$ together with the explicit expressions for ω when only including points and surfaces as observables. We also continue to denote dual functions with a subscript D .

Next, we want to integrate over the torus. If we only write down the parts that are actually dependent on ψ , or equivalently Ω , the integral over the torus is

$$\int_{\mathbb{T}^{b_1}} d\psi \exp \left[\frac{\sqrt{2} i}{2^5 \pi} \left(\frac{d^2 u}{da^2} \right)_D W \wedge \mathbf{x} \otimes \Omega \right] \left(1 + \exp \left[-2\pi i \left(B(\boldsymbol{\rho}_D, \Sigma_g) - \frac{\sqrt{2}}{2^5 \pi} \left(\frac{d\tau}{da} \right)_D \Omega \right) \right] \right)^{-1}. \quad (4.163)$$

A neat trick we can use is to realise that

$$\frac{1}{1 + e^{t+x}} = \frac{1}{1 + e^t} + \sum_{n \geq 1} \text{Li}_{-n}(-e^t) \frac{x^n}{n!}, \quad (4.164)$$

where $\text{Li}_n(y)$ is the polylogarithm [156]. Using this and again splitting $\mathbf{x} = s[\Sigma_g] + t[\mathbb{CP}^1]$ we find that the integral over the torus evaluates to

$$\sum_{n=1}^g \binom{g}{n} \text{Li}_{-n} \left(-\exp \left[-it \left(\frac{du}{da} \right)_D \right] \right) \left(\frac{\sqrt{2}i}{2^{5\pi}} \left(\frac{d^2u}{da^2} \right)_D s \right)^{g-n} \left(\frac{\sqrt{2}i}{2^4} \left(\frac{d\tau}{da} \right)_D \right)^n \quad (4.165)$$

where we dropped the first term coming from (4.164) since this does not contribute to the u -plane integral (it will give a term whose q -series starts with a positive exponent). Combining this with the other terms in the u -plane integral we find that the contribution from the cusp at $\tau = 0$ is given by

$$\begin{aligned} Z_{g,\tau=0}^\epsilon &= \left[\frac{2}{\pi} e^{2pu_D + 2stG_D} \sum_{n=1}^g \binom{g}{n} \text{Li}_{-n} \left(-\exp \left[-it \left(\frac{du}{da} \right)_D \right] \right) \left(-\frac{i}{2} \left(\frac{da}{du} \right)_D \left(\frac{d^2u}{da^2} \right)_D s \right)^{g-n} \right. \\ &\quad \times \left. \left(-i\pi \left(\frac{da}{du} \right)_D \left(\frac{d\tau}{da} \right)_D \right)^n \left(\frac{du}{da} \right)_D \left(\frac{da}{d\tau} \right)_D \right]_{q_D^0}. \end{aligned} \quad (4.166)$$

The contribution from the other cusp is easily calculated using the same procedure. The result is

$$\begin{aligned} Z_{g,\tau=2}^\epsilon &= \left[\frac{2i}{\pi} (-1)^\epsilon e^{-2pu_D - 2stG_D} \sum_{n=1}^g \binom{g}{n} \text{Li}_{-n} \left(-\exp \left[-t \left(\frac{du}{da} \right)_D \right] \right) \left(\frac{i}{2} \left(\frac{da}{du} \right)_D \left(\frac{d^2u}{da^2} \right)_D s \right)^{g-n} \right. \\ &\quad \times \left. \left(-\pi \left(\frac{da}{du} \right)_D \left(\frac{d\tau}{da} \right)_D \right)^n \left(\frac{du}{da} \right)_D \left(\frac{da}{d\tau} \right)_D \right]_{q_D^0}. \end{aligned} \quad (4.167)$$

The full u -plane integral in this chamber is then the sum of these two terms.¹⁰

Genus one

For $g = 1$ the Seiberg-Witten contributions vanish and the only contributions comes from the u -plane integral [156]. The above expressions simplifies to

$$Z_1^\epsilon := Z_{1,\tau=0}^\epsilon + Z_{1,\tau=2}^\epsilon = 2i \left[\frac{e^{itf_D + 2stG_D + 2pu_D}}{(1 + e^{itf_D})^2} + (-1)^\epsilon \frac{e^{tf_D - 2stG_D - 2pu_D}}{(1 + e^{tf_D})^2} \right]_{q^0}, \quad (4.168)$$

where we introduced $f_D = \left(\frac{du}{da} \right)_D$ to keep the expressions shorter. We can make various expansions for this. For example, if $s = t = 0$ we get

$$\begin{aligned} Z_1^0(p) &= i \left(1 + 2p^2 + \frac{2}{3}p^4 + \frac{4}{45}p^6 + \frac{2}{315}p^8 + \mathcal{O}(p^9) \right), \\ Z_1^1(p) &= 2i \left(p + \frac{2}{3}p^3 + \frac{2}{15}p^5 + \frac{4}{315}p^7 + \mathcal{O}(p^9) \right). \end{aligned} \quad (4.169)$$

For $p = 0$ we instead find (expanding in small t)

$$\begin{aligned} Z_1^0(s, t) &= i \left(1 + \frac{1}{2}s^2t^2 - st^3 + \frac{1}{24}(16 + s^4)t^4 + \frac{1}{6}s^3t^5 + \frac{1}{720}s^2(240 + s^4)t^6 + \mathcal{O}(t^7) \right), \\ Z_1^1(s, t) &= i \left(st - t^2 + \frac{1}{6}s^3t^3 - \frac{1}{2}s^2t^4 + \frac{1}{120}s(80 + s^4)t^5 - \frac{1}{360}(136 + 15s^4)t^6 + \mathcal{O}(t^7) \right). \end{aligned} \quad (4.170)$$

¹⁰These expressions again differ from that of the older literature [156] by an overall phase $(-1)^\epsilon (-i)^g$.

Genus two

For $g = 2$ we find

$$Z_2^\epsilon = \frac{\pi i}{2} \left[\left(\frac{d\tau}{da} \right)_D \left(\frac{da}{du} \right)_D^2 e^{-2(stG_D + pu_D)} \right. \\ \times \left(-e^{4stG_D + 4pu_D} \sec^2(tf_D/2) (a_D s - \tan(tf_D/2)) \right. \\ \left. \left. + (-1)^\epsilon \operatorname{sech}^2(tf_D/2) (a_D s - \tanh(tf_D/2)) \right) \right]_{q^0}, \quad (4.171)$$

where by a_D we actually mean $\frac{i}{\pi} \left(\frac{da}{d\tau} \right)_D \left(\frac{d^2u}{da^2} \right)_D$, which are equivalent when expressed in terms of theta functions [74]. For $s = t = 0$ we simply get zero, but for $p = 0$ we get

$$Z_1^0(s, t) = \frac{1}{8}s^2t - \frac{1}{8}st^2 + \frac{4+s^4}{48}t^3 - \frac{1}{48}s^3t^4 + \frac{s^4-40}{960}s^2t^5 + \frac{272-3s^4}{2880}st^6 + \mathcal{O}(t^7), \\ Z_1^1(s, t) = \frac{1}{8}s - \frac{1}{8}t + \frac{1}{16}s^3t^2 - \frac{1}{16}s^2t^3 + \frac{1}{192}s^5t^4 - \frac{1}{192}s^4t^5 + \frac{s^4-160}{5760}s^3t^6 + \mathcal{O}(t^7). \quad (4.172)$$

For $g = 2$ there will also be the Seiberg-Witten contributions given by [156, Eq.(3.33)],

$$Z_{\text{SW}}^{g=2}(p, s, t) = \frac{1}{32}(-1)^\epsilon \left(e^{-2p-st} \sin(2s-2t) - (-1)^\epsilon e^{2p+st} \sinh(2s-2t) \right). \quad (4.173)$$

The first few terms in the expansion for small s and t , and $p = 0$, are

$$Z_{\text{SW}}^{g=2, \epsilon=0}(s, t) = \left(-\frac{s^3}{12} - \frac{s^7}{630} + \mathcal{O}(s^8) \right) + \left(\frac{s^2}{8} - \frac{s^6}{180} + \mathcal{O}(s^8) \right) t \\ + \left(-\frac{s}{8} + \frac{s^5}{120} + \mathcal{O}(s^8) \right) t^2 + \mathcal{O}(t^3), \quad (4.174)$$

and

$$Z_{\text{SW}}^{g=2, \epsilon=1}(s, t) = \left(-\frac{s}{8} - \frac{s^5}{60} + \mathcal{O}(s^8) \right) + \left(\frac{1}{8} + \mathcal{O}(s^8) \right) t \\ + \left(\frac{s^3}{48} - \frac{s^7}{2520} + \mathcal{O}(s^8) \right) t^2 + \mathcal{O}(t^3). \quad (4.175)$$

Chapter 5

Conclusions and outlook

In this thesis we have discussed duality properties of $\mathcal{N} = 2$ supersymmetric Yang-Mills theory as well as its application to the calculation of topological correlators. We were mainly interested in studying the low-energy effective theories, and in particular the Coulomb phase, governed by Seiberg-Witten geometry. We developed new tools for constructing fundamental domains for the running coupling parameterising distinct dynamics. In some specific cases we find ordinary modular behaviour and the domains correspond to fundamental domains of congruence subgroups of $SL(2, \mathbb{Z})$. However, one of the main results of this thesis, following our results in [1-3], was to show that this is not the general story. In theories with massive hypermultiplets we typically find branch points and corresponding branch cuts in the domains. These branch points make the discussion of modularity much more subtle. We developed new tools to deal with these subtleties and showed how one can still construct fundamental domains, even though they do not correspond to those of any subgroup of $SL(2, \mathbb{Z})$.

Many open questions remain with regards to this work. A possible physical interpretation of the branch points has not been understood yet. This would be a very interesting question for further research. One apparent lesson we can draw from the examples studied so far is that the branch points, and their corresponding cuts, provide a mechanism for the fundamental domains to evolve as functions of the masses. At special points in mass space, we find that the branch points can coincide and thus resolve. The observation is that this sometimes happen in the massless limit, while, in contrast, it always seem to happen when the mass is tuned to the value for the superconformal fixed points of Argyres-Douglas type. Physically, these are known to correspond to a second order phase transition of the gauge theory, [159], and perhaps the physics of the branch points can be understood along these lines.

It would furthermore be very interesting to see how this story generalises to more complicated theories. For example the more general theories of class S [160], or five-dimensional gauge theories that are found from geometrical engineering [61, 62], or even the full $SU(3)$ theory beyond the results of Chapter 3. We expect that the methods developed in the papers underlying this thesis can be used to gain better understanding

of these more complicated theories. Another compelling question along these lines is that of mirror maps for compact Calabi-Yau threefolds. In the geometrical engineering setting, the order parameter u , that we have been discussing throughout the thesis, corresponds to the mirror map of the non-compact Calabi-Yau [10]. It is well-known that for compact onefolds (complex tori) and two-folds (K3 surfaces) the mirror map often show modular properties [161, 92, 106, 162]. For threefolds, much less is known and the story seems more subtle. Even though the underlying story is quite different, perhaps the knowledge gained through the work presented in this thesis can be a guiding light in understanding this better. Motivated by the discussion of Chapter 3, for threefolds with $h^{1,1} > 1$ it could be worth looking at interesting subloci of the moduli space. Partial results along this direction has been carried out for certain Calabi-Yau threefolds, with similar results as in the gauge theory, namely duality groups including Fricke involutions play a prominent role [163].

Using the knowledge of the fundamental domains we further showed how to calculate correlators in topologically twisted versions of the supersymmetric gauge theories. In Chapter 4 we constructed the u -plane integral for the theories with gauge group $SU(2)$ and $N_f \leq 3$ fundamental hypermultiplets. In an upcoming work we will elaborate on this and explicitly calculate the integral for certain four-manifolds, similar to the analysis done for the pure theory on a non-simply connected manifold in Sec. 4.6. It would furthermore be interesting to calculate the partition functions of topological versions of more general $\mathcal{N} = 2$ theories, such as those of class S.

Appendix A

Elliptic and modular curves

In this Appendix, we give a brief overview of the important concepts from the theory of elliptic curves as well as introduce the relevant subgroups of $SL(2, \mathbb{Z})$.

A.1 Elliptic curves and complex tori

A hyperelliptic curve of genus g is an algebraic curve defined by an equation of the form

$$y^2 + f_1(x)y = f_2(x), \quad (\text{A.1})$$

with $f_1(x)$ a polynomial of degree less than $g + 2$ and $f_2(x)$ a polynomial of degree $2g + 1$ or $2g + 2$. In this appendix we will only be concerned with genus one curves, which are generally referred to as elliptic curves. We further focus on the case where $f_2(x)$ is a cubic polynomial, as the case of a quartic polynomial can be transformed into this form through a simple change of variables [164]. The cubic case is furthermore the relevant one for the analysis of the SW curves in this thesis. A generic elliptic curve, E , can then be written on the form

$$E : \quad y^2 + a_1xy + a_3y = x^3 + a_2x^2 + a_4x + a_6, \quad (\text{A.2})$$

where a_i are constants [165].

It is useful to introduce two more sets of coefficients, $\{b_i\}$, $\{c_i\}$, defined by

$$\begin{aligned} b_2 &= a_1^2 + 4a_2, & b_4 &= a_1a_3 + 2a_4, & b_6 &= a_3^2 + 4a_6, \\ b_8 &= a_1^2a_6 - a_1a_3a_4 + 4a_2a_6 + a_2a_3^2 - a_4^2, \\ c_4 &= b_2^2 - 24b_4, & c_6 &= -b_2^3 + 36b_2b_4 - 216b_6. \end{aligned} \quad (\text{A.3})$$

It is interesting to study when the curve is singular, this happens whenever two or more roots of the polynomial $f_2(x)$ coincides. This is captured by the discriminant, Δ , of the

polynomial, defined as

$$\Delta = (r_1 - r_2)^2(r_1 - r_3)^2(r_2 - r_3)^2, \quad (\text{A.4})$$

where r_i are the roots of $f_2(x)$. In terms of the coefficients c_i the discriminant can be determined as

$$\Delta(E) = \frac{1}{12^3}(c_4^3 - c_6^2). \quad (\text{A.5})$$

We can further introduce the j -invariant

$$j(E) = \frac{c_4^3}{\Delta}. \quad (\text{A.6})$$

Under an admissible change of variables, j remains invariant. It thus captures isomorphism between elliptic curves, i.e., two elliptic curves E and E' are isomorphic if and only $j(E) = j(E')$.

Complex elliptic curves are complex tori [165, 79]. Let us introduce a lattice L , i.e., a set

$$L = \omega_1\mathbb{Z} \oplus \omega_2\mathbb{Z}, \quad (\text{A.7})$$

with $\omega_1, \omega_2 \in \mathbb{C}$ and normalised such that $\omega_1/\omega_2 \in \mathbb{H}$. Furthermore, we have that two lattices L and L' are equal if and only if

$$\begin{pmatrix} \omega'_1 \\ \omega'_2 \end{pmatrix} = \begin{pmatrix} a & b \\ c & d \end{pmatrix} \begin{pmatrix} \omega_1 \\ \omega_2 \end{pmatrix}, \quad \begin{pmatrix} a & b \\ c & d \end{pmatrix} \in \text{SL}(2, \mathbb{Z}). \quad (\text{A.8})$$

A complex torus is now a quotient of the complex plane with such a lattice, \mathbb{C}/L . Every complex torus is isomorphic to one whose lattice is generated by the complex structure $\tau = \omega_1/\omega_2$ and the number 1. The complex structure is only determined up to the action of $\text{SL}(2, \mathbb{Z})$, due to the non-uniqueness of the lattice under these transformations. In other words, a complex torus determines a point, τ , in the upper half-plane up to the transformations

$$\tau' = \frac{a\tau + b}{c\tau + d}, \quad \begin{pmatrix} a & b \\ c & d \end{pmatrix} \in \text{SL}(2, \mathbb{Z}). \quad (\text{A.9})$$

An important property of elliptic curves is that any elliptic curve can be put on the Weierstraß form

$$\mathcal{W}: \quad y^2 = 4x^3 - g_2x - g_3, \quad (\text{A.10})$$

where g_2 and g_3 are certain functions of the complex structure τ . The discriminant of this curve is given by $\Delta = g_2^3 - 27g_3^2$. In terms of the coefficients a_i , (A.2), they are given by

$$g_2 = -4 \left(a_4 - \frac{a_2^2}{3} \right), \quad g_3 = -4 \left(a_6 + 2\frac{a_2^3}{27} - \frac{a_2a_4}{3} \right). \quad (\text{A.11})$$

We therefore find that the j -invariant can be written as

$$j = 12^3 \frac{g_2^3}{g_2^3 - 27g_3^2}. \quad (\text{A.12})$$

A.2 Modular curves and subgroups

In this Appendix we introduce the subgroups of $\text{SL}(2, \mathbb{Z})$ that are important for the analysis of this thesis. The main objects are the *congruence subgroups*

$$\begin{aligned} \Gamma_0(N) &= \left\{ \begin{pmatrix} a & b \\ c & d \end{pmatrix} \in \text{SL}(2, \mathbb{Z}) \mid c \equiv 0 \pmod{N} \right\}, \\ \Gamma^0(N) &= \left\{ \begin{pmatrix} a & b \\ c & d \end{pmatrix} \in \text{SL}(2, \mathbb{Z}) \mid b \equiv 0 \pmod{N} \right\}, \end{aligned} \quad (\text{A.13})$$

and are related by conjugation with the matrix $\text{diag}(N, 1)$. We furthermore define the *principal congruence subgroup* $\Gamma(N)$ as the subgroup of $\text{SL}(2, \mathbb{Z}) \ni A$ with $A \equiv \mathbb{1} \pmod{N}$.

A subgroup Γ of $\text{SL}(2, \mathbb{Z})$ is a congruence subgroup if $\Gamma \supset \Gamma(N)$ for some $N \in \mathbb{N}$, which is called the *level* of Γ . The (projective) *index* of a congruence subgroup Γ is defined as

$$\text{ind } \Gamma = [\text{PSL}(2, \mathbb{Z}) : \Gamma], \quad (\text{A.14})$$

and it is finite for all N . By $\text{SL}(2, \mathbb{Z})$ we strictly mean $\text{PSL}(2, \mathbb{Z})$ in the following. In fact, one can prove [79]

$$\text{ind } \Gamma(N) = N^3 \prod_{p|N} \left(1 - \frac{1}{p^2}\right), \quad \text{ind } \Gamma^0(N) = N \prod_{p|N} \left(1 + \frac{1}{p}\right), \quad (\text{A.15})$$

where the sum is over all prime divisors of N . It can also be computed in the following way. The volume of the curve $\Gamma \backslash \mathbb{H}$ is defined as

$$\text{vol}(\Gamma \backslash \mathbb{H}) = \int_{\Gamma \backslash \mathbb{H}} d\mu, \quad (\text{A.16})$$

where $d\mu = y^{-2} dx dy$ is the hyperbolic metric on \mathbb{H} , with $\tau = x + iy$. Since $\text{vol}(\text{SL}(2, \mathbb{Z}) \backslash \mathbb{H}) = \frac{\pi}{3}$ can easily be computed, the index of any $\Gamma \subseteq \text{SL}(2, \mathbb{Z})$ is then given by

$$\text{ind } \Gamma = \frac{3}{\pi} \text{vol}(\Gamma \backslash \mathbb{H}). \quad (\text{A.17})$$

For completeness, let us note that the group $\text{SL}(2, \mathbb{R})$ is generated by the set of generators

$$T_t = \begin{pmatrix} 1 & t \\ 0 & 1 \end{pmatrix}, \quad S = \begin{pmatrix} 0 & -1 \\ 1 & 0 \end{pmatrix}, \quad t \in \mathbb{R}, \quad (\text{A.18})$$

while the discrete subgroup $\mathrm{SL}(2, \mathbb{Z})$ is generated by the two elements $T_1 =: T$ and S .

We will furthermore make use of the theta group [166]

$$\Gamma_\theta := \langle T^2, S \rangle \subseteq \mathrm{SL}(2, \mathbb{Z}). \quad (\text{A.19})$$

A fundamental domain for Γ_θ is

$$\Gamma_\theta \backslash \mathbb{H} = \mathcal{F} \cup T\mathcal{F} \cup TS\mathcal{F}, \quad (\text{A.20})$$

with $\mathcal{F} = \mathrm{SL}(2, \mathbb{Z}) \backslash \mathbb{H}$. This demonstrates that Γ_θ has index 3 in $\mathrm{SL}(2, \mathbb{Z})$. It is a congruence subgroup of $\mathrm{SL}(2, \mathbb{Z})$, as [167, 168]¹

$$\Gamma_\theta = \{A \in \mathrm{SL}(2, \mathbb{Z}) \mid A \equiv \mathbb{1} \text{ or } S \pmod{2}\}. \quad (\text{A.21})$$

Let Γ be a congruence subgroup of $\mathrm{SL}(2, \mathbb{Z})$. Cusps of Γ are Γ -equivalence classes of $\mathbb{Q} \cup \{\infty\}$. Adjoining coordinate charts to the cusps and compactifying gives the modular curve $X(\Gamma) := \Gamma \backslash (\mathbb{H} \cup \mathbb{Q} \cup \{i\infty\})$. The isotropy (stabiliser) group of ∞ in $\mathrm{SL}(2, \mathbb{Z})$ is the abelian group of translations,

$$\mathrm{SL}(2, \mathbb{Z})_\infty = \left\{ \begin{pmatrix} 1 & m \\ 0 & 1 \end{pmatrix} : m \in \mathbb{Z} \right\}. \quad (\text{A.22})$$

For each cusp $s \in \mathbb{Q} \cup \{i\infty\}$ some $\delta_s \in \mathrm{SL}(2, \mathbb{Z})$ maps $s \mapsto \infty$. The *width* of s is defined as

$$h_\Gamma(s) = \left| \mathrm{SL}(2, \mathbb{Z})_\infty / (\delta_s \Gamma \delta_s^{-1})_\infty \right|. \quad (\text{A.23})$$

It can be proven that this definition is independent of δ_s . For a fixed group Γ it can be viewed as a well-defined function $\mathbb{Q} \cup \{i\infty\} \rightarrow \mathbb{N}_0$. It is straightforward to show that the sum over the widths of all inequivalent cusps \mathcal{C} is equal to the index [169]

$$\sum_{s \in \mathcal{C}_\Gamma} h_\Gamma(s) = \mathrm{ind} \Gamma. \quad (\text{A.24})$$

Other invariants of modular curves are the elliptic fixed points. A point $\tau \in \mathbb{H}$ is an *elliptic point* for Γ if its isotropy group is nontrivial. The *period* of τ is defined as the order of the isotropy group. It can be shown that any congruence subgroup of $\mathrm{SL}(2, \mathbb{Z})$ has only finitely many elliptic points, and the period for any point $\tau \in \mathbb{H}$ is 1, 2 or 3.

A.3 Kodaira classification of singular fibres

Let us study the singular structure of families of elliptic curves in more detail. To this end, we return to the Weierstraß curve (A.10), where we consider g_2 and g_3 to be

¹It can also be written as the group of matrices $\begin{pmatrix} a & b \\ c & d \end{pmatrix}$ with $a + b + c + d \equiv 0 \pmod{2}$, or $ab \equiv cd \equiv 0 \pmod{2}$.

functions of a parameter u , parameterising the family of elliptic curves. This is the case for the Seiberg-Witten curves we consider in the thesis. As mentioned above, singular points are determined by the zeros of the discriminant $\Delta(u) = g_2(u)^3 - 27g_3(u)^2$, and we are therefore interested in studying the discriminant divisor $\{u|\Delta(u) = 0\}$. This was done by Kodaira and resulted in a complete classification depending on the order of vanishing of g_2 , g_3 and Δ [170, 171]. We list part of this classification in Table A.1, where the order of vanishing of a function f is denoted $\text{ord } f$. The three types *II*, *III* and *IV* always correspond to elliptic points of the SW curves.

type	$\text{ord } g_2$	$\text{ord } g_3$	$\text{ord } \Delta$
<i>I</i> ₀	≥ 0	≥ 0	0
<i>I</i> _{m}	0	0	m
<i>II</i>	≥ 1	1	2
<i>III</i>	1	≥ 2	3
<i>IV</i>	≥ 2	2	4

Table A.1 Part of the Kodaira-Tate table for singular fibres of the Weierstraß model [170, 171].

A.4 Atkin-Lehner involutions

The modular groups of $n|h$ -type, used in Chapter 3, are defined in the following way [36]. We consider matrices

$$\begin{pmatrix} ae & b/h \\ cn & de \end{pmatrix} \tag{A.25}$$

having determinant e , where $a, b, c, d, e, h, n \in \mathbb{Z}$, and h the largest integer for which $h^2|N$ and $h|24$ with $n = N/h$. These matrices are generally referred to as *Atkin-Lehner involutions*.

If n is a positive integer and $h|n$, we define $\Gamma_0(n|h)$ as the set of Atkin-Lehner involutions with unit determinant, i.e., $e = 1$ in the above. Now, for any positive integer e which satisfies $e|n/h$ and $(e, n/eh) = 1$ (such an integer e is called an exact divisor of n/h), one can include also Atkin-Lehner involutions with determinant equal to e , forming a group denoted by $\Gamma_0(n|h) + e$. In fact, this construction works for any choice $\{e_1, e_2, \dots\}$ of exact divisors of n/h , resulting in the group $\Gamma_0(n|h) + e_1, e_2, \dots$. If $h = 1$, we omit the $|h$ in the notation, and in the case that all possible e_i are included, the group is denoted by $\Gamma_0(n|h) +$.

In the Γ^0 convention the notation simplifies, since $\Gamma^0(n|h) = \Gamma^0(\frac{n}{h})$. This can be checked by conjugating (A.25) with $\text{diag}(n, 1)$. The extension by non-unit determinant matrices follows by analogy.

Appendix B

Automorphic forms

This Appendix is dedicated to introducing and listing various important definitions and properties of automorphic forms used throughout the thesis.

B.1 Elliptic modular forms

Let us collect some properties of elliptic modular forms for subgroups of $\mathrm{SL}(2, \mathbb{Z})$. For further reading, see [151, 109, 172, 79, 60, 173].

The Jacobi theta functions $\vartheta_j : \mathbb{H} \rightarrow \mathbb{C}$, $j = 2, 3, 4$, are defined as

$$\vartheta_2(\tau) = \sum_{r \in \mathbb{Z} + \frac{1}{2}} q^{r^2/2}, \quad \vartheta_3(\tau) = \sum_{n \in \mathbb{Z}} q^{n^2/2}, \quad \vartheta_4(\tau) = \sum_{n \in \mathbb{Z}} (-1)^n q^{n^2/2}, \quad (\text{B.1})$$

with $q = e^{2\pi i \tau}$. These functions transform under $T, S \in \mathrm{SL}(2, \mathbb{Z})$ as

$$\begin{aligned} S : & \begin{cases} \vartheta_2(-1/\tau) = \sqrt{-i\tau} \vartheta_4(\tau), \\ \vartheta_3(-1/\tau) = \sqrt{-i\tau} \vartheta_3(\tau), \\ \vartheta_4(-1/\tau) = \sqrt{-i\tau} \vartheta_2(\tau), \end{cases} \\ T : & \begin{cases} \vartheta_2(\tau + 1) = e^{\frac{\pi i}{4}} \vartheta_2(\tau), \\ \vartheta_3(\tau + 1) = \vartheta_4(\tau), \\ \vartheta_4(\tau + 1) = \vartheta_3(\tau). \end{cases} \end{aligned} \quad (\text{B.2})$$

They furthermore satisfy the Jacobi abstruse identity

$$\vartheta_2^4 + \vartheta_4^4 = \vartheta_3^4. \quad (\text{B.3})$$

The derivatives of the Jacobi theta functions gives quasi-modular forms [151],

$$\begin{aligned} D\vartheta_2^4 &= \frac{1}{6}\vartheta_2^4 (E_2 + \vartheta_3^4 + \vartheta_4^4), \\ D\vartheta_3^4 &= \frac{1}{6}\vartheta_3^4 (E_2 + \vartheta_2^4 - \vartheta_4^4), \\ D\vartheta_4^4 &= \frac{1}{6}\vartheta_4^4 (E_2 - \vartheta_2^4 - \vartheta_3^4), \end{aligned} \quad (\text{B.4})$$

where $D := \frac{1}{2\pi i} \frac{d}{d\tau} = q \frac{d}{dq}$ and E_2 is the quasi-modular Eisenstein series (B.7) of weight 2, transforming as (B.8).

The modular lambda function $\lambda = \frac{\vartheta_2^4}{\vartheta_3^4}$ is a Hauptmodul for $\Gamma(2)$. The Dedekind eta function $\eta : \mathbb{H} \rightarrow \mathbb{C}$ is defined as the infinite product

$$\eta(\tau) = q^{\frac{1}{24}} \prod_{n=1}^{\infty} (1 - q^n), \quad q = e^{2\pi i \tau}. \quad (\text{B.5})$$

It transforms under the generators of $\text{SL}(2, \mathbb{Z})$ as

$$\begin{aligned} S : \quad \eta(-1/\tau) &= \sqrt{-i\tau} \eta(\tau), \\ T : \quad \eta(\tau + 1) &= e^{\frac{\pi i}{12}} \eta(\tau), \end{aligned} \quad (\text{B.6})$$

and relates to the Jacobi theta series as $\eta^3 = \frac{1}{2}\vartheta_2\vartheta_3\vartheta_4$.

The Eisenstein series $E_k : \mathbb{H} \rightarrow \mathbb{C}$ for even $k \geq 2$ are defined as the q -series

$$E_k(\tau) = 1 - \frac{2k}{B_k} \sum_{n=1}^{\infty} \sigma_{k-1}(n) q^n, \quad (\text{B.7})$$

with $\sigma_k(n) = \sum_{d|n} d^k$ the divisor sum. For $k \geq 4$ even, E_k is a modular form of weight k for $\text{SL}(2, \mathbb{Z})$. On the other hand E_2 is a quasi-modular form, which means that the $\text{SL}(2, \mathbb{Z})$ transformation of E_2 includes a shift in addition to the weight,

$$E_2\left(\frac{a\tau + b}{c\tau + d}\right) = (c\tau + d)^2 E_2(\tau) - \frac{6i}{\pi} c(c\tau + d). \quad (\text{B.8})$$

From the S -transformation, we find that

$$E_4(e^{\pi i/3}) = 0, \quad E_6(i) = 0, \quad (\text{B.9})$$

and the zeros are unique in $\text{SL}(2, \mathbb{Z}) \backslash \mathbb{H}$ according to the valence formula for modular forms on $\text{SL}(2, \mathbb{Z})$. Any modular form for $\text{SL}(2, \mathbb{Z})$ can be related to the Jacobi theta functions (B.1) by

$$E_4 = \frac{1}{2}(\vartheta_2^8 + \vartheta_3^8 + \vartheta_4^8), \quad E_6 = \frac{1}{2}(\vartheta_2^4 + \vartheta_3^4)(\vartheta_3^4 + \vartheta_4^4)(\vartheta_4^4 - \vartheta_2^4). \quad (\text{B.10})$$

All quasi-modular forms for $\mathrm{SL}(2, \mathbb{Z})$ can be expressed as polynomials in E_2 , E_4 and E_6 . The derivatives of the Eisenstein series are quasi-modular,

$$E_2' = \frac{2\pi i}{12}(E_2^2 - E_4), \quad E_4' = \frac{2\pi i}{3}(E_2E_4 - E_6), \quad E_6' = \frac{2\pi i}{2}(E_2E_6 - E_4^2). \quad (\text{B.11})$$

These equations give the differential ring structure of quasi-modular forms on $\mathrm{PSL}(2, \mathbb{Z})$. With our normalisation (B.7) the j -invariant can be written as

$$j = 1728 \frac{E_4^3}{E_4^3 - E_6^2} = 256 \frac{(\vartheta_3^8 - \vartheta_3^4 \vartheta_4^4 + \vartheta_4^8)^3}{\vartheta_2^8 \vartheta_3^8 \vartheta_4^8}. \quad (\text{B.12})$$

Another class of theta series is provided by the one of the A_2 root lattice, $b_{3,j} : \mathbb{H} \rightarrow \mathbb{C}$,

$$b_{3,j}(\tau) = \sum_{k_1, k_2 \in \mathbb{Z} + \frac{j}{3}} q^{k_1^2 + k_2^2 + k_1 k_2}, \quad j \in \{-1, 0, 1\}. \quad (\text{B.13})$$

It is clear that $b_{3,-1} = b_{3,1}$. The transformation properties under $\mathrm{SL}(2, \mathbb{Z})$ are ($\omega_3 = e^{2\pi i/3}$)

$$\begin{aligned} S : \quad b_{3,j} \left(-\frac{1}{\tau} \right) &= -\frac{i\tau}{\sqrt{3}} \sum_{l \pmod{3}} \omega_3^{2jl} b_{3,l}(\tau), \\ T : \quad b_{3,j}(\tau + 1) &= \omega_3^{j^2} b_{3,j}(\tau). \end{aligned} \quad (\text{B.14})$$

The $b_{3,j}$ series can be expressed through the Dedekind eta function (B.5) as

$$b_{3,0}(\tau) = \frac{\eta(\frac{\tau}{3})^3 + 3\eta(3\tau)^3}{\eta(\tau)}, \quad b_{3,1}(\tau) = 3 \frac{\eta(3\tau)^3}{\eta(\tau)}. \quad (\text{B.15})$$

It furthermore relates to the quasi-modular Eisenstein series E_2 by

$$E_2\left(\frac{\tau}{3}\right) - 3E_2(\tau) = -2b_{3,0}\left(\frac{\tau}{3}\right)^2. \quad (\text{B.16})$$

A relation to the Jacobi theta functions is given by

$$b_{3,0}(\tau) = \vartheta_3(2\tau)\vartheta_3(6\tau) + \vartheta_2(2\tau)\vartheta_2(6\tau). \quad (\text{B.17})$$

Quotients of η -functions are frequently used to generate bases for the spaces of modular functions for congruence subgroups of $\mathrm{SL}(2, \mathbb{Z})$. We use the following

Theorem 1 ([109, 108]). *Let $f(\tau) = \prod_{\delta|N} \eta(\delta\tau)^{r_\delta}$ be an η -quotient with $k = \frac{1}{2} \sum_{\delta|N} r_\delta \in \mathbb{Z}$ and $\sum_{\delta|N} \delta r_\delta \equiv \sum_{\delta|N} \frac{N}{\delta} r_\delta \equiv 0 \pmod{24}$. Then, f is a weakly holomorphic modular form for $\Gamma_0(N)$ with weight k .*

B.2 Siegel-Narain theta function

Let L be an n -dimensional uni-modular lattice with signature $(1, n - 1)$. For the application to the u -plane integral in Section 4.4, $n = b_2(X)$. Let K be a characteristic vector of L . Its defining property is $\mathbf{l}^2 = \mathbf{l} \cdot K \pmod 2$ for every $\mathbf{l} \in L$. Furthermore, we have that $\boldsymbol{\mu} \in L/2$.

We consider the Siegel-Narain theta function $\Psi_{\boldsymbol{\mu}}^J : \mathbb{H} \times \mathbb{C} \rightarrow \mathbb{C}$ defined in the main text in (4.50). We repeat it here for convenience,

$$\begin{aligned} \Psi_{\boldsymbol{\mu}}^J(\tau, \bar{\tau}, \mathbf{z}, \bar{\mathbf{z}}) &= e^{-2\pi y b_+^2} \sum_{\mathbf{k} \in L + \boldsymbol{\mu}} \partial_{\bar{\tau}} (4\pi i \sqrt{y} B(\mathbf{k} + \mathbf{b}, J)) \\ &\times (-1)^{B(\mathbf{k}, K)} q^{-\mathbf{k}_-^2/2} \bar{q}^{\mathbf{k}_+^2/2} e^{-2\pi i B(\mathbf{z}, \mathbf{k}_-) - 2\pi i B(\bar{\mathbf{z}}, \mathbf{k}_+)}, \end{aligned} \quad (\text{B.18})$$

where J is a normalised positive vector in $L \otimes \mathbb{R}$, $\mathbf{k}_+ = B(\mathbf{k}, J) J$, $\mathbf{k}_- = \mathbf{k} - \mathbf{k}_+$ and $\mathbf{b} = \text{Im}(\mathbf{z})/y$. The transformations under the generators S and T of $\text{PSL}(2, \mathbb{Z})$ are most easily determined if we shift $\boldsymbol{\mu} \rightarrow \boldsymbol{\mu} + K/2$. One finds [43, 46]

$$\begin{aligned} S : \quad & \Psi_{\boldsymbol{\mu} + K/2}^J(-1/\tau, -1/\bar{\tau}, \mathbf{z}/\tau, \bar{\mathbf{z}}/\bar{\tau}) = -i(-i\tau)^{n/2} (i\bar{\tau})^2 \\ & \times e^{-\pi i \mathbf{z}^2/\tau + \pi i K^2/2} (-1)^{B(\boldsymbol{\mu}, K)} \Psi_{K/2}^J(\tau, \bar{\tau}, \mathbf{z} - \boldsymbol{\mu}, \bar{\mathbf{z}} - \boldsymbol{\mu}), \\ T : \quad & \Psi_{\boldsymbol{\mu} + K/2}^J(\tau + 1, \bar{\tau} + 1, \mathbf{z}, \bar{\mathbf{z}}) = \\ & e^{\pi i(\boldsymbol{\mu}^2 - K^2/4)} \Psi_{\boldsymbol{\mu} + K/2}^J(\tau, \bar{\tau}, \mathbf{z} + \boldsymbol{\mu}, \bar{\mathbf{z}} + \boldsymbol{\mu}). \end{aligned} \quad (\text{B.19})$$

Using these transformations, one finds for the periodicity in τ ,

$$\Psi_{\boldsymbol{\mu}}^J(\tau + 1, \bar{\tau} + 1, \mathbf{z}, \bar{\mathbf{z}}) = e^{\pi i(\boldsymbol{\mu}^2 - B(\boldsymbol{\mu}, K))} \Psi_{\boldsymbol{\mu}}^J(\tau, \bar{\tau}, \mathbf{z} + \boldsymbol{\mu} - K/2, \bar{\mathbf{z}} + \boldsymbol{\mu} - K/2) \quad (\text{B.20})$$

and for $S^{-1}T^{-k}S = \begin{pmatrix} 1 & 0 \\ k & 1 \end{pmatrix}$,

$$\Psi_{\boldsymbol{\mu}}^J\left(\frac{\tau}{k\tau+1}, \frac{\bar{\tau}}{k\bar{\tau}+1}, \frac{\mathbf{z}}{k\tau+1}, \frac{\bar{\mathbf{z}}}{k\bar{\tau}+1}\right) = (k\tau+1)^{\frac{n}{2}} (k\bar{\tau}+1)^2 e^{-\frac{\pi i k \mathbf{z}^2}{k\tau+1}} e^{\frac{\pi i k K^2}{4}} \Psi_{\boldsymbol{\mu}}^J(\tau, \bar{\tau}, \mathbf{z}, \bar{\mathbf{z}}). \quad (\text{B.21})$$

We furthermore list the following transformations for \mathbf{z} :

- For the reflection $\mathbf{z} \rightarrow -\mathbf{z}$,

$$\Psi_{\boldsymbol{\mu}}^J(\tau, \bar{\tau}, -\mathbf{z}, -\bar{\mathbf{z}}) = -e^{2\pi i B(\boldsymbol{\mu}, K)} \Psi_{\boldsymbol{\mu}}^J(\tau, \bar{\tau}, \mathbf{z}, \bar{\mathbf{z}}). \quad (\text{B.22})$$

- For shifting $\mathbf{z} \rightarrow \mathbf{z} + \boldsymbol{\nu}$ with $\boldsymbol{\nu} \in L$,

$$\Psi_{\boldsymbol{\mu}}^J(\tau, \bar{\tau}, \mathbf{z} + \boldsymbol{\nu}, \bar{\mathbf{z}} + \boldsymbol{\nu}) = e^{-2\pi i B(\boldsymbol{\nu}, \boldsymbol{\mu})} \Psi_{\boldsymbol{\mu}}^J(\tau, \bar{\tau}, \mathbf{z}, \bar{\mathbf{z}}). \quad (\text{B.23})$$

- For shifting $\mathbf{z} \rightarrow \mathbf{z} + \boldsymbol{\nu}\tau$ with $\boldsymbol{\nu} \in L \otimes \mathbb{R}$,

$$\Psi_{\boldsymbol{\mu}}^J(\tau, \mathbf{z} + \boldsymbol{\nu}\tau) = e^{2\pi i B(\mathbf{z}, \boldsymbol{\nu})} q^{\boldsymbol{\nu}^2/2} (-1)^{-B(\boldsymbol{\nu}, K)} \Psi_{\boldsymbol{\mu} + \boldsymbol{\nu}}^J(\tau, \bar{\tau}, \mathbf{z}, \bar{\mathbf{z}}). \quad (\text{B.24})$$

We can restrict to $\nu \in L/2$, if the characteristic $\mu + \nu$ is required to be in $L/2$.

B.3 Indefinite theta functions

In this appendix we present various aspects of indefinite theta functions and their modular completions, which are important for the analysis in Sec. 4.6. As above, we assume that the associated lattice L is uni-modular and of signature $(1, n - 1)$.

To define the indefinite theta function, we choose two positive definite vectors J and $J' \in L \otimes \mathbb{R}$ with $B(J, J') > 0$, such that they both lie in the same positive cone of L . Let \underline{J} and \underline{J}' be their normalisations. The arguments of theta function are $\tau \in \mathbb{H}$, $\mathbf{z} \in L \otimes \mathbb{C}$ and $\mu \in L \otimes \mathbb{R}$. We let $\mathbf{b} = \text{Im}(\mathbf{z})/y \in L \otimes \mathbb{R}$. In terms of this data, the indefinite theta function $\Theta_\mu^{JJ'}$ is defined as

$$\Theta_\mu^{JJ'}(\tau, \mathbf{z}) = \sum_{\mathbf{k} \in L + \mu} \frac{1}{2} (\text{sgn}(B(\mathbf{k} + \mathbf{b}, J)) - \text{sgn}(B(\mathbf{k} + \mathbf{b}, J'))) (-1)^{B(\mathbf{k}, K)} q^{-\mathbf{k}^2/2} e^{-2\pi i B(\mathbf{z}, \mathbf{k})}. \quad (\text{B.25})$$

It is possible to show that the sum over L is convergent [158]. However, $\Theta_\mu^{JJ'}$ does only transform as a modular form after the addition of certain non-holomorphic terms. Reference [158] explains that the modular completion $\widehat{\Theta}_\mu^{JJ'}$ of $\Theta_\mu^{JJ'}$ is obtained by substituting (rescaled) error functions for the sgn-functions in (B.25). The completion $\widehat{\Theta}_\mu^{JJ'}$ then transforms as a modular form of weight $n/2$, and is explicitly given by

$$\widehat{\Theta}_\mu^{JJ'}(\tau, \mathbf{z}) = \sum_{\mathbf{k} \in L + \mu} \frac{1}{2} \left(E(\sqrt{2y} B(\mathbf{k} + \mathbf{b}, \underline{J})) - E(\sqrt{2y} B(\mathbf{k} + \mathbf{b}, \underline{J}')) \right) \times (-1)^{B(\mathbf{k}, K)} q^{-\mathbf{k}^2/2} e^{-2\pi i B(\mathbf{z}, \mathbf{k})}, \quad (\text{B.26})$$

where E is a reparametrisation of the error function

$$E : \mathbb{R} \rightarrow (-1, 1), \quad t \mapsto 2 \int_0^t e^{-\pi x^2} dx. \quad (\text{B.27})$$

Note that in the limit $y \rightarrow \infty$, E in (B.26) approaches the original sgn-function of (B.25),

$$\lim_{y \rightarrow \infty} E(\sqrt{2y} u) = \text{sgn}(u).$$

If we analytically continue E to a function with complex argument, then this limit is only convergent for $-\frac{\pi}{4} < \text{Arg}(u) < \frac{\pi}{4}$.

For the action of the generators of $\text{SL}(2, \mathbb{Z})$ on $\widehat{\Theta}_{\mu+K/2}^{JJ'}(\tau, \mathbf{z})$ one finds [158, 174]

$$\begin{aligned} \widehat{\Theta}_{\mu+K/2}^{JJ'}(\tau + 1, \mathbf{z}) &= e^{\pi i(\mu^2 - K^2/4)} \widehat{\Theta}_{\mu+K/2}^{JJ'}(\tau, \mathbf{z} + \mu), \\ \widehat{\Theta}_{\mu+K/2}^{JJ'}(-1/\tau, \mathbf{z}/\tau) &= i(-i\tau)^{n/2} \exp(-\pi i \mathbf{z}^2/\tau + \pi i K^2/2) \widehat{\Theta}_{K/2}^{JJ'}(\tau, \mathbf{z} - \mu). \end{aligned} \quad (\text{B.28})$$

For our applications, the $\bar{\tau}$ -derivative of $\widehat{\Theta}_\mu^{JJ'}$ is of particular interest. This gives the “shadow” of $\Theta_\mu^{JJ'}$, whose modular properties are easier to determine than those of $\Theta_\mu^{JJ'}$. We obtain here

$$\partial_{\bar{\tau}} \widehat{\Theta}_\mu^{JJ'}(\tau, \mathbf{z}) = \Psi_\mu^J(\tau, \mathbf{z}) - \Psi_\mu^{J'}(\tau, \mathbf{z}), \quad (\text{B.29})$$

with Ψ_μ^J defined in (B.18). The modular properties of Ψ_μ^J were given above, and can be obtained using standard Poisson resummation.

The completion (B.26) may simplify if the lattice L contains vectors $\mathbf{k}_0 \in L$ with norm $\mathbf{k}_0^2 = 0$. For such lattices J and/or J' can be chosen to equal such a vector, and careful analysis of the limit shows that the error function reduces to the original sgn-function [158]. We assume now that $J' \in L$ such that $(J')^2 = 0$. To ensure convergence of the sum, one needs to require furthermore that $B(\mathbf{k} + \mathbf{b}, J') \neq 0$ for any $\mathbf{k} \in L + K/2 + \mu$, except if one also has $B(\mathbf{k} + \mathbf{b}, J) = 0$. Then the completion $\widehat{\Theta}_\mu^{JJ'}$ is given by

$$\begin{aligned} \widehat{\Theta}_\mu^{JJ'}(\tau, \mathbf{z}) = & \sum_{\mathbf{k} \in L + K/2 + \mu} \frac{1}{2} \left(E(\sqrt{2y}B(\mathbf{k} + \mathbf{b}, \underline{J})) - \text{sgn}(B(\mathbf{k} + \mathbf{b}, J')) \right) \\ & \times (-1)^{B(\mathbf{k}, K)} q^{-\mathbf{k}^2/2} e^{-2\pi i B(\mathbf{z}, \mathbf{k})}, \end{aligned} \quad (\text{B.30})$$

with shadow

$$\partial_{\bar{\tau}} \widehat{\Theta}_\mu^{JJ'}(\tau, \mathbf{z}) = \Psi_\mu^J(\tau, \mathbf{z}). \quad (\text{B.31})$$

B.4 Bimodular forms

For our application to $N_f = 4$ SQCD, Sec. 2.3, we will adopt the following definition of a bimodular form, due to [3]:

Definition 1 (Bimodular form). *Let $(\Gamma_1, \Gamma_2; \Gamma)$ be a triple of subgroups of $SL(2, \mathbb{R})$ commensurable with $SL(2, \mathbb{Z})$.¹ A two-variable meromorphic function $F : \mathbb{H} \times \mathbb{H} \rightarrow \mathbb{C}$ is called a bimodular form of weight (k_1, k_2) for the triple $(\Gamma_1, \Gamma_2; \Gamma)$ if it satisfies both Condition 1 & 2:*

- *Condition 1: For all $\gamma_i = \begin{pmatrix} a_i & b_i \\ c_i & d_i \end{pmatrix} \in \Gamma_i$, $i = 1, 2$, F transforms as*

$$F(\gamma_1 \tau_1, \gamma_2 \tau_2) = \chi(\gamma_1, \gamma_2) (c_1 \tau_1 + d_1)^{k_1} (c_2 \tau_2 + d_2)^{k_2} F(\tau_1, \tau_2), \quad (\text{B.32})$$

for a certain multiplier $\chi : \Gamma_1 \times \Gamma_2 \rightarrow \mathbb{C}^$. We call this the separate transformation of F under (Γ_1, Γ_2) , and denote it by $(\Gamma_1)_{\tau_1} \times (\Gamma_2)_{\tau_2}$.*

¹A subgroup $\Gamma \subset SL(2, \mathbb{R})$ is commensurable with $SL(2, \mathbb{Z})$ if $\Gamma \cap SL(2, \mathbb{Z})$ has finite index in both $SL(2, \mathbb{Z})$ and $SL(2, \mathbb{R})$. This includes in particular all congruence subgroups of $SL(2, \mathbb{Z})$.

- *Condition 2: For all $\gamma = \begin{pmatrix} a & b \\ c & d \end{pmatrix} \in \Gamma$, F transforms as*

$$F(\gamma\tau_1, \gamma\tau_2) = \phi(\gamma) (c\tau_1 + d)^{k_1} (c\tau_2 + d)^{k_2} F(\tau_1, \tau_2), \quad (\text{B.33})$$

for a multiplier $\phi : \Gamma \rightarrow \mathbb{C}^*$. We call this the *simultaneous transformation* of F under Γ , and denote it by $\Gamma_{(\tau_1, \tau_2)}$.

Note that condition 2 follows from condition 1 if Γ is the intersection of Γ_1 and Γ_2 , $\Gamma = \Gamma_1 \cap \Gamma_2$ with $\phi(\gamma) = \chi(\gamma, \gamma)$, $\gamma \in \Gamma$.

This definition contains the main aspects of other definitions of bimodular forms in the literature [175–177, 39].

We further make use of the notion of a *vector valued bimodular form* introduced in [3]:

Definition 2 (Vector-valued bimodular form). *Let*

$$\mathbf{F} = \begin{pmatrix} F_1 \\ \vdots \\ F_p \end{pmatrix} : \mathbb{H} \times \mathbb{H} \rightarrow \mathbb{C}^p \quad (\text{B.34})$$

be a p -tuple of two-variable meromorphic functions, $p \in \mathbb{N}$. Then \mathbf{F} is called a *vector-valued bimodular form of weight (k_1, k_2)* for $\Gamma \subset SL(2, \mathbb{Z})$, if

- *each component F_j is a bimodular form of weight (k_1, k_2) for some triple $(\Gamma_1^j, \Gamma_2^j; \Gamma^j)$, as in definition 1, and*
- *there exists a p -dimensional complex representation $\rho : \Gamma \rightarrow GL(p, \mathbb{C})$ such that*

$$\mathbf{F}(\gamma\tau_1, \gamma\tau_2) = (c\tau_1 + d)^{k_1} (c\tau_2 + d)^{k_2} \rho(\gamma) \mathbf{F}(\tau_1, \tau_2) \quad (\text{B.35})$$

for all $\gamma = \begin{pmatrix} a & b \\ c & d \end{pmatrix} \in \Gamma$ and all $\tau_1, \tau_2 \in \mathbb{H}$.

B.5 Siegel modular forms

Ordinary modular forms are constructed by the action of an $SL(2, \mathbb{Z})$ Möbius transformation on the upper half-plane \mathbb{H} . Siegel modular forms [151, 178] generalise this notion by introducing an action of $Sp(2g, \mathbb{Z})$ on the so-called Siegel upper half-plane \mathbb{H}_g , which works for any *genus* $g \in \mathbb{N}$.

Define the Siegel modular group of genus g as

$$Sp(2g, \mathbb{Z}) = \{M \in \text{Mat}(2g; \mathbb{Z}) \mid M^T J M = J\} \quad \text{with } J = \begin{pmatrix} 0 & \mathbb{1}_g \\ -\mathbb{1}_g & 0 \end{pmatrix}. \quad (\text{B.36})$$

The group $\mathrm{Sp}(4, \mathbb{Z})$ can be generated [151] by the elements J and $T = \begin{pmatrix} 1_g & s \\ 0 & 1_g \end{pmatrix}$ with $s = s^T$. The Siegel upper half-plane

$$\mathbb{H}_g = \{\Omega \in \mathrm{Mat}(g; \mathbb{C}) \mid \Omega^T = \Omega, \mathrm{Im} \Omega > 0\} \quad (\text{B.37})$$

consists of complex symmetric $g \times g$ matrices whose (componentwise) imaginary part is positive definite. This generalises the ordinary upper half-plane $\mathbb{H} = \mathbb{H}_1$. For example, for $g = 2$ this means that

$$\Omega = \begin{pmatrix} \tau_{11} & \tau_{12} \\ \tau_{12} & \tau_{22} \end{pmatrix}, \quad \mathrm{Im} \tau_{11} > 0, \quad \mathrm{Im} \tau_{11} \mathrm{Im} \tau_{22} - (\mathrm{Im} \tau_{12})^2 > 0. \quad (\text{B.38})$$

An element $\gamma = \begin{pmatrix} A & B \\ C & D \end{pmatrix} \in \mathrm{Sp}(2g, \mathbb{Z})$ acts on the Siegel upper half-plane by

$$\Omega \longmapsto \gamma(\Omega) = (A\Omega + B)(C\Omega + D)^{-1}. \quad (\text{B.39})$$

A (classical) Siegel modular form of weight k and genus g is then a holomorphic function $f : \mathbb{H}_g \rightarrow \mathbb{C}$ satisfying

$$f(\gamma(\Omega)) = \det(C\Omega + D)^k f(\Omega), \quad \forall \gamma = \begin{pmatrix} A & B \\ C & D \end{pmatrix} \in \mathrm{Sp}(2g, \mathbb{Z}), \quad (\text{B.40})$$

where for $g = 1$ holomorphicity at $i\infty$ is required in addition.

Theta series provide an explicit class of classical Siegel modular forms. For $a, b \in \mathbb{Q}^2$ and $\Omega \in \mathbb{H}_2$, define

$$\Theta \begin{bmatrix} a \\ b \end{bmatrix} (\Omega) = \sum_{k \in \mathbb{Z}^2} \exp\left(\pi i(k+a)^T \Omega (k+a) + 2\pi i(k+a)^T b\right). \quad (\text{B.41})$$

We are especially interested in the case where the entries of these column vectors take values in the set $\{0, \frac{1}{2}\}$. The corresponding theta functions are usually referred to as the theta characteristics. We call $\gamma = \begin{bmatrix} a \\ b \end{bmatrix}$ an even (odd) characteristic if $4a^T b$ is even (odd). In the case of genus two there are ten even theta constants [179],

$$\begin{aligned} \Theta_1 &= \Theta \begin{bmatrix} 0 & 0 \\ 0 & 0 \end{bmatrix}, \quad \Theta_2 = \Theta \begin{bmatrix} 0 & 0 \\ \frac{1}{2} & \frac{1}{2} \end{bmatrix}, \quad \Theta_3 = \Theta \begin{bmatrix} 0 & 0 \\ \frac{1}{2} & 0 \end{bmatrix}, \quad \Theta_4 = \Theta \begin{bmatrix} 0 & 0 \\ 0 & \frac{1}{2} \end{bmatrix}, \quad \Theta_5 = \Theta \begin{bmatrix} \frac{1}{2} & 0 \\ 0 & 0 \end{bmatrix}, \\ \Theta_6 &= \Theta \begin{bmatrix} \frac{1}{2} & 0 \\ 0 & \frac{1}{2} \end{bmatrix}, \quad \Theta_7 = \Theta \begin{bmatrix} 0 & \frac{1}{2} \\ 0 & 0 \end{bmatrix}, \quad \Theta_8 = \Theta \begin{bmatrix} \frac{1}{2} & \frac{1}{2} \\ 0 & 0 \end{bmatrix}, \quad \Theta_9 = \Theta \begin{bmatrix} 0 & \frac{1}{2} \\ \frac{1}{2} & 0 \end{bmatrix}, \quad \Theta_{10} = \Theta \begin{bmatrix} \frac{1}{2} & \frac{1}{2} \\ \frac{1}{2} & \frac{1}{2} \end{bmatrix}. \end{aligned} \quad (\text{B.42})$$

All even theta constants can be related through algebraic identities to four *fundamental* ones, $\Theta_1, \Theta_2, \Theta_3, \Theta_4$ [179].

The above theta functions are weight $\frac{1}{2}$ Siegel modular forms for a subgroup of $\mathrm{Sp}(4, \mathbb{Z})$. Their transformation properties under the Siegel modular group can be found in [178].

Appendix C

Picard-Fuchs solutions for SU(3) theory

In the limit of large u and small v , reference [95] determines the a_I and $a_{D,I}$ non-perturbatively in terms of the fourth Appell hypergeometric function $F_4(a, b, c, d; x, y)$. For $\sqrt{|x|} + \sqrt{|y|} < 1$, this function is given by

$$F_4(a, b, c, d; x, y) = \sum_{m, n \geq 0} \frac{(a)_{m+n} (b)_{m+n}}{m! n! (c)_m (d)_n} x^m y^n, \quad (\text{C.1})$$

where $(a)_m = \frac{\Gamma(a+m)}{\Gamma(a)}$ is the Pochhammer symbol. We will also need expansions of F_4 for large y , which can be achieved by replacing the sum over n by the hypergeometric series ${}_2F_1$,

$$F_4(a, b, c, d; x, y) = \sum_{m \geq 0} \frac{(a)_m (b)_m}{m! (c)_m} {}_2F_1(a+m, b+m, d; y) x^m. \quad (\text{C.2})$$

While analytic continuations are known for ${}_2F_1$, they are not well established for F_4 .

C.1 Classical roots

In order to match the Picard-Fuchs solutions with the periods, we need to expand the periods around the classical solutions in (3.4). We therefore need to find the roots of these two cubics.

The general formula for the roots of a depressed cubic equation, $ax^3 + bx + c = 0$, is given by

$$\xi_k = -\frac{1}{3a} \left(\alpha^k C + \frac{\Delta_0}{\alpha^k C} \right), \quad k \in \{0, 1, 2\}, \quad (\text{C.3})$$

where $\alpha = e^{2\pi i/3}$, $C^3 = \frac{\Delta_1 \pm \sqrt{\Delta_1^2 - 4\Delta_0}}{2}$, $\Delta_0 = -3ab$ and $\Delta_1 = 27a^2c$ [180]. The choice of sign in front of the square root in C is arbitrary, in the sense that it only corresponds to a permutation of the roots.

It is however important to fix the ambiguities in taking the square and cubic root. We fix the ambiguity in the square root by the following choice for the branch of the logarithm: For any complex number $z \in \mathbb{C}^*$, we set $\log(z) = \log|z| + i \text{Arg}(z)$ with $-\pi < \text{Arg}(z) \leq \pi$. The ambiguity in the cubic root of a complex number z is fixed by demanding that the real part of $\sqrt[3]{z}$ has the largest absolute value among the three solutions to $\rho^3 = z$. Thus $\sqrt[3]{1} = 1$ and $\sqrt[3]{-1} = -1$. Two of the cube roots of i and $-i$ have equal real parts. We fix the remaining ambiguity by setting $\sqrt[3]{i} = e^{\pi i/6} = \frac{\sqrt{3}}{2} + \frac{i}{2}$ and $\sqrt[3]{-i} = e^{-\pi i/6} = \frac{\sqrt{3}}{2} - \frac{i}{2}$.

To list the roots of our two equations, we define

$$s_{\pm}(a, b) = \sqrt[3]{\frac{b}{2} \pm \sqrt{\frac{b^2}{4} - \frac{a^3}{27}}}. \quad (\text{C.4})$$

Using Eq. (C.3), we then find that the roots of (3.4) for a_1 are given by

$$\begin{aligned} \xi_1(u, v) &= s_+(u, v) + s_-(u, v), \\ \xi_2(u, v) &= \alpha s_+(u, v) + \alpha^2 s_-(u, v), \\ \xi_3(u, v) &= \alpha^2 s_+(u, v) + \alpha s_-(u, v), \end{aligned} \quad (\text{C.5})$$

and the roots for a_2 by $-\xi_j(u, v)$. This gives the $3 \times 3 = 9$ solutions to the equations in (3.4). However, (3.3) is supposed to have only $2 \times 3 = 6$ solutions. Let us determine the 6 solutions in one of the regimes of interest for SU(3) Yang-Mills theory: we assume u is large and close to the positive axis: $u = \lambda - i\epsilon\lambda$ with λ real and very large and $0 < \epsilon \ll 1$. Note that in this regime

$$s_{\pm}(u, v) = \sqrt[3]{\frac{v}{2} \pm i \sqrt{\frac{u^3}{27} - \frac{v^2}{4}}}. \quad (\text{C.6})$$

Furthermore, $s_+(u, v) s_-(u, v) = u/3$ and $s_-(u, -v) = e^{-\pi i/3} s_+(u, v) = -\alpha s_+(u, v)$ hold. For $v = 0$, we have $s_+(u, 0) = e^{\pi i/6} \sqrt{u/3}$ and $s_-(u, 0) = e^{-\pi i/6} \sqrt{u/3}$, and thus

$$\begin{aligned} \xi_1(u, 0) &= \sqrt{u}, \\ \xi_2(u, 0) &= -\sqrt{u}, \\ \xi_3(u, 0) &= 0. \end{aligned} \quad (\text{C.7})$$

This demonstrates that the solutions to (3.3) for (a_1, a_2) are given by

$$(\xi_1, -\xi_2), (\xi_1, -\xi_3), (\xi_2, -\xi_1), (\xi_2, -\xi_3), (\xi_3, -\xi_1), (\xi_3, -\xi_2). \quad (\text{C.8})$$

C.2 Picard-Fuchs system for large u

To express a_I and $a_{D,I}$ in terms of u and v , we will start by working in the patch with large u and small v , and use the variables $x = \frac{27v^2}{4u^3}$ and $y = \frac{27\Lambda^6}{4u^3}$. In [95] the authors use the notation P_3 for this patch and, similarly, P_2 for the patch where v is large and u is small and we will adopt this notation in the following. We have four solutions [95, Eq. (6.1)] to the Picard-Fuchs system [95, Eq. (5.11)] for $SU(3)$,

$$\begin{aligned}\omega_1^{P_3} &= \sqrt{3} 2^{\frac{2}{3}} \Lambda y^{-\frac{1}{6}} F_4\left(-\frac{1}{6}, \frac{1}{6}, \frac{1}{2}, 1; x, y\right), \\ \omega_2^{P_3} &= \frac{2^{\frac{2}{3}} \Lambda}{3} \sqrt{x} y^{-\frac{1}{6}} F_4\left(\frac{1}{3}, \frac{2}{3}, \frac{3}{2}, 1; x, y\right), \\ \Omega_1^{P_3} &= 36\pi e^{-\pi i/6} 2^{2/3} \Lambda \frac{\Gamma(\frac{1}{3})}{\Gamma(\frac{1}{6})^2} F_4\left(-\frac{1}{6}, -\frac{1}{6}, \frac{1}{2}, \frac{2}{3}; \frac{x}{y}, \frac{1}{y}\right) + \beta_1^{P_3} \omega_1^{P_3}, \\ \Omega_2^{P_3} &= -e^{\frac{\pi i}{3}} \frac{2^{\frac{2}{3}} \Lambda}{\sqrt{3} 2\pi} \Gamma(\frac{1}{3})^3 \sqrt{\frac{x}{y}} F_4\left(\frac{1}{3}, \frac{1}{3}, \frac{3}{2}, \frac{2}{3}; \frac{x}{y}, \frac{1}{y}\right) + \beta_2^{P_3} \omega_2^{P_3},\end{aligned}\tag{C.9}$$

where $\beta_1^{P_3} = (i - \sqrt{3})\pi + 4\log(2) + 3\log(3) - 5$ and $\beta_2^{P_3} = 1 + (i + \frac{1}{\sqrt{3}})\pi + 3\log(3)$. The a_I and $a_{D,I}$ are linear combinations of these periods found by comparing the expansions of these solutions with the classical and semi-classical solutions in the previous section for large u . Using the classical solutions $(a_1, a_2) = (\xi_1, -\xi_2)$ one finds [95, Eq. 6.4],

$$\begin{aligned}a_{D,1}(u, v) &= -\frac{i}{4\pi} (\Omega_1^{P_3} + 3\Omega_2^{P_3}) - \frac{1}{\pi} (\alpha_1 \omega_1^{P_3} - \alpha_2 \omega_2^{P_3}) \\ &= -\frac{i}{2\pi} \left(\sqrt{u} + \frac{3v}{2u} \right) \log\left(\frac{27\Lambda^6}{4u^3}\right) - \frac{1}{\pi} \left(\frac{i}{2} + 2\alpha_1 \right) \sqrt{u} + O(u^{-1}), \\ a_{D,2}(u, v) &= -\frac{i}{4\pi} (\Omega_1^{P_3} - 3\Omega_2^{P_3}) - \frac{1}{\pi} (\alpha_1 \omega_1^{P_3} + \alpha_2 \omega_2^{P_3}) = a_{D,1}(u, -v) \\ a_1(u, v) &= \frac{1}{2} (\omega_1^{P_3} + \omega_2^{P_3}) \sim \sqrt{u} + \frac{1}{2} \frac{v}{u} + \dots, \\ a_2(u, v) &= \frac{1}{2} (\omega_1^{P_3} - \omega_2^{P_3}) \sim \sqrt{u} - \frac{1}{2} \frac{v}{u} + \dots,\end{aligned}\tag{C.10}$$

with $\alpha_1 = \frac{5i}{4} - i\log(2) - \frac{3i}{4}\log(3)$ and $\alpha_2 = \frac{3i}{4} + \frac{9i}{4}\log(3)$. The chain rule then allows to compute the coupling matrix,

$$\Omega(u, v) = \begin{pmatrix} \partial_u a_1 & \partial_u a_2 \\ \partial_v a_1 & \partial_v a_2 \end{pmatrix}^{-1} \begin{pmatrix} \partial_u a_{D,1} & \partial_u a_{D,2} \\ \partial_v a_{D,1} & \partial_v a_{D,2} \end{pmatrix}.\tag{C.11}$$

C.3 Picard-Fuchs system for large v

We can run a similar analysis as in the previous section for the patch P_2 , i.e., for large v and small u . This is not done explicitly in [95] but the authors hint at how it should be done. Here, we use the variables $x = \frac{4u^3}{27v^2}$ and $y = \frac{\Lambda^6}{v^2}$ to express the solutions of the

Picard-Fuchs equations as ($\alpha = e^{2\pi i/3}$)

$$\begin{aligned}
\omega_1^{P_2} &= 2y^{-1/6} F_4 \left(-\frac{1}{6}, \frac{1}{3}, \frac{2}{3}, 1; x, y \right), \\
\omega_2^{P_2} &= 2^{1/3} x^{1/3} y^{-1/6} F_4 \left(\frac{1}{6}, \frac{2}{3}, \frac{4}{3}, 1; x, y \right), \\
\Omega_1^{P_2} &= -\frac{\alpha^2}{2} \pi^{-3/2} \Gamma \left(-\frac{1}{6} \right) \Gamma \left(\frac{2}{3} \right) F_4 \left(-\frac{1}{6}, -\frac{1}{6}, \frac{2}{3}, \frac{1}{2}; \frac{x}{y}, \frac{1}{y} \right) + \beta_1^{P_2} \omega_1^{P_2}, \\
\Omega_2^{P_2} &= -\frac{\alpha}{3} \pi^{-3/2} \sqrt[3]{\frac{x}{y}} \Gamma \left(-\frac{2}{3} \right) \Gamma \left(\frac{1}{6} \right) F_4 \left(\frac{1}{6}, \frac{1}{6}, \frac{4}{3}, \frac{1}{2}; \frac{x}{y}, \frac{1}{y} \right) + \beta_2^{P_2} \omega_2^{P_2},
\end{aligned} \tag{C.12}$$

with

$$\begin{aligned}
\beta_1^{P_2} &= -\frac{i}{4\pi} \left(2 \log 2 + 3 \log 3 - 6 + \pi(i - 2/\sqrt{3}) \right), \\
\beta_2^{P_2} &= -\frac{i}{24/3\pi} \left(2 \log 2 + 3 \log 3 + \pi(i + 2/\sqrt{3}) \right).
\end{aligned} \tag{C.13}$$

Comparing the expansions of these solutions with the asymptotic expansions of $a_{(D),I}$ for the semi-classical contributions fixes the coefficients. For this, one needs to match the F_4 expansions with the leading coefficients of the (differentiated) prepotential [93]

$$\mathcal{F} = \frac{\tau_0}{6} \sum_{i=1}^3 Z_i^2 + \mathcal{F}_{1\text{-loop}} + \mathcal{F}_{inst.}, \tag{C.14}$$

where

$$\tau_0 = \frac{9 - \log 4}{2\pi i}. \tag{C.15}$$

From this, one finds

$$\begin{aligned}
a_{D,1} &= -i\sqrt{3}\alpha \left(\Omega_1^{P_2} - 2^{-2/3}\alpha\Omega_2^{P_2} \right) + \left(\alpha c_1 - \frac{i\sqrt{3}}{2} \right) \omega_1^{P_2} + \left(\alpha^2 c_2 + \frac{i\sqrt{3}}{2} \right) \omega_2^{P_2}, \\
a_{D,2} &= -i\sqrt{3} \left(\Omega_1^{P_2} - 2^{-2/3}\Omega_2^{P_2} \right) + \left(c_1 + \frac{i\sqrt{3}}{2} \right) \omega_1^{P_2} + \left(c_2 - \frac{i\sqrt{3}}{2} \right) \omega_2^{P_2}, \\
a_1 &= \frac{1}{2} \left(\omega_1^{P_2} + \omega_2^{P_2} \right), \\
a_2 &= -\frac{\alpha}{2} \left(\omega_1^{P_2} + \alpha\omega_2^{P_2} \right),
\end{aligned} \tag{C.16}$$

where $c_1 = \frac{\sqrt{3}}{4\pi} \left(2 \log 2 + 3 \log 3 + \frac{\pi}{\sqrt{3}} - 6 \right)$ and $c_2 = -\frac{\sqrt{3}}{4\pi} \left(2 \log 2 + 3 \log 3 - \frac{\pi}{\sqrt{3}} \right)$. We note that for $u = 0$, we find $a_2 = -\alpha a_1$.

C.4 The \mathbb{Z}_2 vacua and massless states

In deriving the above results for the large v regime we have used a different symplectic basis than what is used in for example [95, 19]. In this subsection we briefly comment on how the two bases relate. The basis chosen in [95, 19] is more natural to use when comparing such quantities as the strong coupling periods for the two different loci, and in this basis we also compute the periods for all the points of interest. The change of basis is done by interchanging the roots $\xi_2 \leftrightarrow \xi_3$ as given in (C.5). Quantum mechanically,

the singular branch of the classical theory splits into two branches separated by the scale Λ . Therefore, we must also interchange $r_2 \leftrightarrow r_3$ and $r_5 \leftrightarrow r_6$. One finds that this symplectic change of basis is given by the semi-classical version of the second Weyl reflection of the A_2 root lattice,

$$\mathcal{R}_2 = \begin{pmatrix} 1 & 1 & 0 & 0 \\ 0 & -1 & 0 & 0 \\ 0 & 0 & 1 & 0 \\ 0 & 0 & 1 & -1 \end{pmatrix} \in \mathrm{Sp}(4, \mathbb{Z}). \quad (\text{C.17})$$

This merely changes some prefactors of the solution (C.16). The change of roots modifies the cross-ratios in a trivial way, and they agree asymptotically with the theta quotients (3.17) computed from the new periods, as expected. One can show that the algebraic relations (3.66) for $u = 0$ take the same form. However, on this locus we now find

$$\tau_{12} = \frac{1 - \tau_{11}}{2}, \quad \tau_{22} = \tau_{11} - 2, \quad (\text{C.18})$$

from which it follows that

$$\begin{aligned} 2i\sqrt{27}v &= -\alpha^2 q^{-\frac{1}{6}} + 33\alpha q^{\frac{1}{6}} + 153q^{\frac{1}{2}} + 713\alpha^2 q^{\frac{5}{6}} + \mathcal{O}(q^{\frac{7}{6}}) \\ &= m\left(-\alpha q^{\frac{1}{6}}\right) = m\left(\frac{\tau}{6} - \frac{1}{6}\right), \end{aligned} \quad (\text{C.19})$$

which is identical to (3.71) up to phases.

We can use the new solution to analyse the \mathbb{Z}_3 symmetry $u \mapsto \alpha u$. This leads to the matrix

$$\tilde{\sigma}_v = \alpha^2 \begin{pmatrix} 0 & 1 & -1 & 2 \\ -1 & -1 & 2 & -1 \\ 0 & 0 & -1 & 1 \\ 0 & 0 & -1 & 0 \end{pmatrix}. \quad (\text{C.20})$$

It can also be obtained from the previous result (3.102) by conjugation with \mathcal{R}_2 . It satisfies $\tilde{\sigma}_v^3 = \mathbb{1}$ and we can use it to generate the charges of the states that become massless at the \mathbb{Z}_2 points. To this end, we introduce the purely integral matrix $U = \alpha^2 \tilde{\sigma}_v^{-1} \in \mathrm{Sp}(4, \mathbb{Z})$, which is the matrix used in [95, 19], and act with this on the monopole basis,

$$\begin{aligned} \tilde{\nu}_1 &= (1, 0, 0, 0), & \tilde{\nu}_2 &= (0, 1, 0, 0), \\ \tilde{\nu}_3 &= \tilde{\nu}_1 U = (-1, -1, 1, -2), & \tilde{\nu}_4 &= \tilde{\nu}_2 U = (1, 0, -2, 1), \\ \tilde{\nu}_5 &= \tilde{\nu}_1 U^{-1} = (0, 1, -1, 2), & \tilde{\nu}_6 &= \tilde{\nu}_2 U^{-1} = (-1, -1, 2, -1). \end{aligned} \quad (\text{C.21})$$

Using the periods from Table C.1 we can confirm that $\tilde{\nu}_{\{1,3,5\}}$ become massless at the AD point $(0, 1)$ and $\tilde{\nu}_{\{2,3,6\}}$ at the AD point $(0, -1)$. Furthermore, the charges in row

(\underline{u}, v)	$\pi(\underline{u}, v)$	normalisation
$(0, 1)$	$(0, -\sqrt{3}i, 1, -\alpha^2)$	$\Gamma\left(\frac{1}{3}\right)\Gamma\left(\frac{7}{6}\right)/2^{1/3}\sqrt{\pi}$
$(0, -1)$	$(-\sqrt{3}i, 0, -\alpha, 1)$	
$(1, 0)$	$(0, 0, 1, 1)$	$\sqrt[3]{2}\pi/3\sqrt{3}$
$(\alpha, 0)$	$(\alpha^2, \alpha^2, 0, -\alpha^2)$	
$(\alpha^2, 0)$	$(-\alpha, -\alpha, -\alpha, 0)$	
$(0, 0)$	$(-i, -i, -\omega^5, \omega)$	$2\sqrt{\frac{\pi}{3}}\Gamma\left(\frac{7}{6}\right)/\Gamma\left(\frac{2}{3}\right)$

Table C.1 Periods at the \mathbb{Z}_3 , \mathbb{Z}_2 points and the origin, computed from the analytic continuation of the large v PF solution and appropriately normalized.

$k + 1$ in (C.21) become massless at the \mathbb{Z}_2 point $(\underline{u}, v) = (\alpha^k, 0)$. It can be checked that the charges in each row are mutually local with respect to the symplectic inner product induced by J , given in (B.36). The charges in both columns however are mutually non-local. This is a crucial observation that lead to the discovery of new superconformal theories [9, 70].

The matrix (C.20) conjugates the strong coupling matrices [95] as well as the semi-classical matrices according to

$$\tilde{\sigma}_v^{-1} M^{(r_1)} \tilde{\sigma}_v = M^{(r_2)}, \quad \tilde{\sigma}_v^{-1} M^{(r_2)} \tilde{\sigma}_v = M^{(r_3)}, \quad \tilde{\sigma}_v^{-1} M^{(r_3)} \tilde{\sigma}_v = M^{(r_1)}. \quad (\text{C.22})$$

The same equations hold for the \mathbb{Z}_2 symmetry

$$\tilde{\rho}_v = \begin{pmatrix} 1 & 1 & -2 & 1 \\ -1 & 0 & 4 & -2 \\ 0 & 0 & 0 & 1 \\ 0 & 0 & -1 & 1 \end{pmatrix}, \quad (\text{C.23})$$

as is also the case for large u . As a consistency check, the pair $(\tilde{\sigma}_v, \tilde{\rho}_v)$ again satisfies the relation (3.101), and $\tilde{\rho}_v^2$ is a non-trivial monodromy. The matrix $\tilde{\rho}_v$ maps $\{\tilde{\nu}_2, \tilde{\nu}_4, \tilde{\nu}_6\}$ to $\{-\tilde{\nu}_1, -\tilde{\nu}_3, -\tilde{\nu}_5\}$ and therefore exchanges the AD points $v = \pm 1$.

The periods in Table C.1 obtain different values depending on the direction from which the various points are approached.¹ On the locus \mathcal{E}_u , where $v = 0$, we have three singularities located at $\underline{u} = 1, \alpha, \alpha^2$. Reference [73] argues that one finds consistent values if the points are approached from the negative real axis. In this way we can go from weak to strong coupling without crossing walls of the second kind.² On \mathcal{E}_v , with

¹This is not only a problem involving monodromies. By computing coupling matrices at the origin from different directions we find that they generally do not lie in the Siegel upper half-plane \mathbb{H}_2 , even though it is a regular point of the curve. One cannot place them back in \mathbb{H}_2 by acting on them with monodromy matrices in $\text{Sp}(4, \mathbb{Z})$.

²Walls of the second kind are generally defined as hypersurfaces where a fixed quiver QM description of the BPS spectrum breaks down, and one needs to mutate the quiver to find the spectrum on the other side of the wall [73].

$u = 0$, we instead have two singularities on the real line at $v = \pm 1$, analogous to the u -plane in the pure $SU(2)$ theory. There, we find a consistent picture by taking the limits from the lower half-plane in order to avoid the singular points (see discussion in [35]).

The two patches with large u and large v (from this subsection) respectively are connected by a simple change of basis. It is given by

$$\mathcal{M} = \mathcal{M}_{\tilde{\nu}_2} = \begin{pmatrix} 1 & 0 & 0 & 0 \\ 0 & 1 & 0 & 0 \\ 0 & 0 & 1 & 0 \\ 0 & -1 & 0 & 1 \end{pmatrix}. \quad (\text{C.24})$$

This matrix is the strong coupling monodromy (3.106) associated with the magnetic monopole $\tilde{\nu}_2 = (0, 1, 0, 0)$ [95].

References

- [1] Johannes Aspman, Elias Furrer, and Jan Manschot. Elliptic Loci of $SU(3)$ Vacua. *Annales Henri Poincare*, 22(8):2775–2830, 2021.
- [2] Johannes Aspman, Elias Furrer, and Jan Manschot. Cutting and gluing with running couplings in $N=2$ QCD. *Phys. Rev. D*, 105(2):025021, 2022.
- [3] Johannes Aspman, Elias Furrer, and Jan Manschot. Four flavors, triality, and bimodular forms. *Phys. Rev. D*, 105(2):025017, 2022.
- [4] Johannes Aspman, Elias Furrer, Georgios Korpas, Zhi-Cong Ong, and Meng-Chwan Tan. The u -plane integral, mock modularity and enumerative geometry. *Lett. Math. Phys.*, 112:30, 2022.
- [5] Johannes Aspman, Elias Furrer, and Jan Manschot. Topological twists of massive SQCD, Part I, June 2022. arXiv: 2206.08943.
- [6] Christos Aravanis, Johannes Aspman, Georgios Korpas, and Jakub Marecek. Polynomial matrix inequalities within tame geometry, June 2022. arXiv: 2206.03941.
- [7] Nathan Seiberg and Edward Witten. Electric - magnetic duality, monopole condensation, and confinement in $N=2$ supersymmetric Yang-Mills theory. *Nucl. Phys.*, B426:19–52, 1994. [Erratum: *Nucl. Phys.*B430,485(1994)].
- [8] Nathan Seiberg and Edward Witten. Monopoles, duality and chiral symmetry breaking in $N=2$ supersymmetric QCD. *Nucl. Phys.*, B431:484–550, 1994.
- [9] Philip C. Argyres and Michael R. Douglas. New phenomena in $SU(3)$ supersymmetric gauge theory. *Nucl. Phys.*, B448:93–126, 1995.
- [10] Sheldon H. Katz, Albrecht Klemm, and Cumrun Vafa. Geometric engineering of quantum field theories. *Nucl. Phys. B*, 497:173–195, 1997.
- [11] Davide Gaiotto. $N=2$ dualities. *JHEP*, 08:034, 2012.
- [12] Claus Montonen and David I. Olive. Magnetic Monopoles as Gauge Particles? *Phys. Lett. B*, 72:117–120, 1977.
- [13] Luis Alvarez-Gaume and S. F. Hassan. Introduction to S duality in $N=2$ supersymmetric gauge theories: A Pedagogical review of the work of Seiberg and Witten. *Fortsch. Phys.*, 45:159–236, 1997.
- [14] Jeffrey A. Harvey. Magnetic monopoles, duality and supersymmetry. In *ICTP Summer School in High-energy Physics and Cosmology*, 3 1996.
- [15] Wolfgang Lerche. Introduction to Seiberg-Witten theory and its stringy origin. *Nucl. Phys. Proc. Suppl.*, 55B:83–117, 1997. [Fortsch. Phys.45,293(1997)].

- [16] Jose Labastida and Marcos Marino. *Topological quantum field theory and four manifolds*. Springer, Dordrecht, 2005.
- [17] Yuji Tachikawa. *N=2 supersymmetric dynamics for dummies*. Dec 2013. Lect. Notes Phys., Volume 890.
- [18] Albrecht Klemm, Wolfgang Lerche, Peter Mayr, Cumrun Vafa, and Nicholas P. Warner. Selfdual strings and N=2 supersymmetric field theory. *Nucl. Phys. B*, 477:746–766, 1996.
- [19] Marcos Marino and Gregory W. Moore. The Donaldson-Witten function for gauge groups of rank larger than one. *Commun. Math. Phys.*, 199:25–69, 1998.
- [20] Werner Nahm. On the Seiberg-Witten approach to electric - magnetic duality. Aug. 1996. arXiv: hep-th/9608121.
- [21] Hiroaki Kanno and Yūji Ohta. Picard-fuchs equation and prepotential of five-dimensional susy gauge theory compactified on a circle. *Nuclear Physics B*, 530(1-2):73–98, Oct 1998.
- [22] Kenneth A. Intriligator and Nathan Seiberg. Lectures on supersymmetric gauge theories and electric-magnetic duality. *Nucl. Phys. B Proc. Suppl.*, 45BC:1–28, 1996.
- [23] Marcos Mariño. *Instantons and Large N: An Introduction to Non-Perturbative Methods in Quantum Field Theory*. Cambridge University Press, 2015.
- [24] Nathan Seiberg. Supersymmetry and Nonperturbative beta Functions. *Phys. Lett. B*, 206:75–80, 1988.
- [25] Yuji Ohta. Prepotential of N=2 SU(2) Yang-Mills gauge theory coupled with a massive matter multiplet. *J. Math. Phys.*, 37:6074–6085, 1996.
- [26] Yuji Ohta. Prepotentials of N=2 SU(2) Yang-Mills theories coupled with massive matter multiplets. *Journal of Mathematical Physics*, 38(2):682–696, Feb 1997.
- [27] Eric D’Hoker, Igor M. Krichever, and Duong H. Phong. The effective prepotential of N = 2 supersymmetric SU(Nc) gauge theories. *Nuclear Physics B*, 489(1-2):179–210, Mar 1997.
- [28] Nikita A. Nekrasov. Seiberg-Witten prepotential from instanton counting. *Adv. Theor. Math. Phys.*, 7(5):831–864, 2003.
- [29] Cumrun Vafa and Edward Witten. A Strong coupling test of S-duality. *Nucl. Phys.*, B431:3–77, 1994.
- [30] Evgeny B Bogomol’nyi. The stability of classical solutions. *Sov. J. Nucl. Phys. (Engl. Transl.); (United States)*, 24:4, Oct. 1976.
- [31] M. K. Prasad and Charles M. Sommerfield. An Exact Classical Solution for the ’t Hooft Monopole and the Julia-Zee Dyon. *Phys. Rev. Lett.*, 35:760–762, 1975.
- [32] Edward Witten. Dyons of charge $e\theta/2\pi$. *Phys. Lett. B*, 86:283–287, 1979.
- [33] Albrecht Klemm, Wolfgang Lerche, Shimon Yankielowicz, and Stefan Theisen. On the monodromies of N=2 supersymmetric Yang-Mills theory. In *Joint U.S.-Polish Workshop on Physics from Planck Scale to Electro-Weak Scale (SUSY 94)*, 8 1994.

- [34] Ulf H. Danielsson and Bo Sundborg. The Moduli space and monodromies of $N=2$ supersymmetric $SO(2r+1)$ Yang-Mills theory. *Phys. Lett.*, B358:273–280, 1995.
- [35] Frank Ferrari and Adel Bilal. The Strong coupling spectrum of the Seiberg-Witten theory. *Nucl. Phys.*, B469:387–402, 1996.
- [36] Charles R. Ferenbaugh. The genus-zero problem for $n|h$ -type groups. *Duke Math. J.*, 72(1):31–63, 10 1993.
- [37] Edward Witten. Topological Quantum Field Theory. *Commun. Math. Phys.*, 117:353, 1988.
- [38] Anton Kapustin and Edward Witten. Electric-Magnetic Duality And The Geometric Langlands Program. *Commun. Num. Theor. Phys.*, 1:1–236, 2007.
- [39] Jan Manschot and Gregory W. Moore. Topological correlators of $SU(2)$, $N = 2^*$ SYM on four-manifolds. Apr 2021. arXiv: 2104.06492.
- [40] Gregory W. Moore and Edward Witten. Integration over the u plane in Donaldson theory. *Adv. Theor. Math. Phys.*, 1:298–387, 1997.
- [41] Edward Witten. Monopoles and four manifolds. *Math. Res. Lett.*, 1:769–796, 1994.
- [42] Edward Witten. On S duality in Abelian gauge theory. *Selecta Math.*, 1:383, 1995.
- [43] Georgios Korpas and Jan Manschot. Donaldson-Witten theory and indefinite theta functions. *JHEP*, 11:083, 2017.
- [44] Gregory W. Moore and Iurii Nidaiev. The Partition Function Of Argyres-Douglas Theory On A Four-Manifold. 2017. arXiv: 1711.09257.
- [45] Georgios Korpas, Jan Manschot, Gregory Moore, and Iurii Nidaiev. Renormalization and BRST Symmetry in Donaldson–Witten Theory. *Annales Henri Poincare*, 20(10):3229–3264, 2019.
- [46] Georgios Korpas, Jan Manschot, Gregory Moore, and Iurii Nidaiev. Mocking the u -plane integral. *Research in the Mathematical Sciences*, 8, 09 2021.
- [47] Georgios Korpas. Mock modularity and surface defects in topological $\mathcal{N} = 2$ super Yang-Mills theory. *Phys. Rev. D*, 105(2):026025, 2022.
- [48] Min-xin Huang and Albrecht Klemm. Holomorphicity and Modularity in Seiberg-Witten Theories with Matter. *JHEP*, 07:083, 2010.
- [49] Andreas Malmendier. The Signature of the Seiberg-Witten surface. *Surveys Diff. Geom.*, 15:255–278, 2010.
- [50] Tetsuji Shioda. On elliptic modular surfaces. *J. Math. Soc. Japan*, 24(1):20–59, 01 1972.
- [51] Matthias Schuett and Tetsuji Shioda. Elliptic surfaces, 2009. arXiv: 0907.0298.
- [52] Robert S. Maier. On Rationally Parametrized Modular Equations. *arXiv Mathematics e-prints*, page math/0611041, November 2006.
- [53] Rick Miranda. An overview of algebraic surfaces. *Lecture Notes in Pure and Appl. Math.*, pages 157–217, 1997.

- [54] Tohru Eguchi. *Seiberg-Witten Theory and S-Duality*, pages 103–120. Springer Netherlands, Dordrecht, 1999.
- [55] Goro Shimura. *Introduction to the Arithmetic Theory of Automorphic Functions*. Kanô memorial lectures. Princeton University Press, 1971.
- [56] Katsushi Ito and Sung-Kil Yang. Prepotentials in N=2 SU(2) supersymmetric Yang-Mills theory with massless hypermultiplets. *Phys. Lett. B*, 366:165–173, 1996.
- [57] Hiroaki Kanno and Sung-Kil Yang. Donaldson-Witten functions of massless N=2 supersymmetric QCD. *Nucl. Phys. B*, 535:512–530, 1998.
- [58] Askold Khovanskii. *Galois Theory, Coverings, and Riemann Surfaces*. Springer Berlin Heidelberg, 2013.
- [59] Chan Y. Park. Ramification Points of Seiberg-Witten Curves. *JHEP*, 07:068, 2011.
- [60] Dan Schultz. Notes on modular forms. URL: <https://faculty.math.illinois.edu/~schult25/ModFormNotes.pdf>.
- [61] Cyril Closset and Horia Magureanu. The U -plane of rank-one 4d $\mathcal{N} = 2$ KK theories. *SciPost Phys.*, 12(2):065, 2022.
- [62] Horia Magureanu. Seiberg-Witten geometry, modular rational elliptic surfaces and BPS quivers. *JHEP*, 05:163, 2022.
- [63] Antoine Bourget and Jan Troost. Permutations of Massive Vacua. *JHEP*, 05:042, 2017.
- [64] Frank Ferrari. On the Geometry of Super Yang-Mills Theories: Phases and Irreducible Polynomials. *JHEP*, 01:026, 2009.
- [65] Frank Ferrari. Galois symmetries in Super Yang-Mills Theories. *JHEP*, 03:128, 2009.
- [66] Yang-Hui He and James Read. Hecke Groups, Dessins d’Enfants and the Archimedean Solids. *Front. in Phys.*, 3:91, 2015.
- [67] Sujay K. Ashok, Freddy Cachazo, and Eleonora Dell’Aquila. Children’s drawings from Seiberg-Witten curves. *Commun. Num. Theor. Phys.*, 1:237–305, 2007.
- [68] Sujay K. Ashok, Freddy Cachazo, and Eleonora Dell’Aquila. Strebel differentials with integral lengths and Argyres-Douglas singularities. 10 2006. arXiv: hep-th/0610080.
- [69] Yang-Hui He and John McKay. N=2 Gauge Theories: Congruence Subgroups, Coset Graphs and Modular Surfaces. *J. Math. Phys.*, 54:012301, 2013.
- [70] Philip C. Argyres, M. Ronen Plesser, Nathan Seiberg, and Edward Witten. New N=2 superconformal field theories in four-dimensions. *Nucl. Phys.*, B461:71–84, 1996.
- [71] Jihye Seo and Keshav Dasgupta. Argyres-Douglas Loci, Singularity Structures and Wall-Crossings in Pure N=2 Gauge Theories with Classical Gauge Groups. *JHEP*, 05:072, 2012.

- [72] Daniel Zwanziger. Quantum field theory of particles with both electric and magnetic charges. *Phys. Rev.*, 176:1489–1495, Dec 1968.
- [73] Murad Alim, Sergio Cecotti, Clay Cordova, Sam Espahbodi, Ashwin Rastogi, and Cumrun Vafa. $\mathcal{N} = 2$ quantum field theories and their BPS quivers. *Adv. Theor. Math. Phys.*, 18(1):27–127, 2014.
- [74] Marco Matone. Instantons and recursion relations in $N=2$ SUSY gauge theory. *Phys. Lett.*, B357:342–348, 1995.
- [75] Marco Matone. Koebe $1/4$ theorem and inequalities in $n=2$ supersymmetric qcd. *Phys. Rev. D*, 53:7354–7358, Jun 1996.
- [76] Jacob Sonnenschein, Stefan Theisen, and Shimon Yankielowicz. On the relation between the holomorphic prepotential and the quantum moduli in susy gauge theories. *Physics Letters B*, 367(1-4):145–150, Jan 1996.
- [77] Tohru Eguchi and Sung-Kil Yang. Prepotentials of $N=2$ supersymmetric gauge theories and soliton equations. *Mod. Phys. Lett.*, A11:131–138, 1996.
- [78] R Flume, F Fucito, J. F Morales, and R Poghossian. Matone’s relation in the presence of gravitational couplings. *Journal of High Energy Physics*, 2004(04):008–008, Apr 2004.
- [79] Fred Diamond and Jerry Shurman. *A First Course in Modular Forms*, volume 228 of *Graduate Texts in Mathematics*. Springer-Verlag New York, 1 edition, 2005.
- [80] Andreas Brandhuber and Stephan Stieberger. Periods, coupling constants and modular functions in $N=2$ $SU(2)$ SYM with massive matter. *Int. J. Mod. Phys. A*, 13:1329–1344, 1998.
- [81] Tohru Eguchi and Hiroaki Kanno. Five-dimensional gauge theories and local mirror symmetry. *Nucl. Phys. B*, 586:331–345, 2000.
- [82] Tohru Eguchi, Kentaro Hori, Katsushi Ito, and Sung-Kil Yang. Study of $N=2$ superconformal field theories in four-dimensions. *Nucl. Phys. B*, 471:430–444, 1996.
- [83] Min-xin Huang, Amir-Kian Kashani-Poor, and Albrecht Klemm. The Ω deformed B-model for rigid $\mathcal{N} = 2$ theories. *Annales Henri Poincare*, 14:425–497, 2013.
- [84] Adel Bilal and Frank Ferrari. The BPS spectra and superconformal points in massive $N=2$ supersymmetric QCD. *Nucl. Phys. B*, 516:175–228, 1998.
- [85] Theodore Gamelin. *Complex Analysis*. Undergraduate Texts in Mathematics. Springer New York, 2003.
- [86] D. Alexander, C. Cummins, J. McKay, and C. Simons. "Completely replicable functions" in Groups, Combinatorics, and Geometry, Durham Symposium, 1990, *London Math. Soc. Lecture Note Ser.* **165**, Cambridge Univ. Press, Cambridge, 1992.
- [87] David Ford, John McKay, and Simon Norton. More on replicable functions. *Communications in Algebra*, 22(13):5175–5193, 1994.
- [88] J Frank Adams. *Lectures on exceptional lie groups*. Chicago lectures in mathematics. Chicago Univ. Press, Chicago, IL, 1996.

- [89] William Fulton and Joe Harris. *Representation Theory*. Springer New York, 2004.
- [90] Marcos Marino and Frederic Zamora. Duality symmetry in softly broken $N=2$ gauge theories. *Nucl. Phys. B*, 533:373–405, 1998.
- [91] Ta-Sheng Tai. Triality in $SU(2)$ Seiberg-Witten theory and Gauss hypergeometric function. *Phys. Rev. D*, 82:105007, 2010.
- [92] Albrecht Klemm, Bong H. Lian, Shi-Shyr Roan, and Shing-Tung Yau. A Note on ODEs from mirror symmetry. July 1994. arXiv: hep-th/9407192.
- [93] Albrecht Klemm, Wolfgang Lerche, Shimon Yankielowicz, and Stefan Theisen. Simple singularities and $N=2$ supersymmetric Yang-Mills theory. *Phys. Lett.*, B344:169–175, 1995.
- [94] Philip C. Argyres and Alon E. Faraggi. The vacuum structure and spectrum of $N=2$ supersymmetric $SU(n)$ gauge theory. *Phys. Rev. Lett.*, 74:3931–3934, 1995.
- [95] Albrecht Klemm, Wolfgang Lerche, and Stefan Theisen. Nonperturbative effective actions of $N=2$ supersymmetric gauge theories. *Int. J. Mod. Phys.*, A11:1929–1974, 1996.
- [96] Georg Rosenhain. Abhandlung über die functionen zweier variablen mit vier perioden welche die inversion sind der ultra-elliptische integrale erster klasse (1851). Translation to German from Latin manuscript published in: *Klassiker der Exacten Wissenschaften*, 65:1 – 96, 1895.
- [97] Jun ichi Igusa. Modular forms and projective invariants. *American Journal of Mathematics*, 89(3):817–855, 1967.
- [98] Jun-Ichi Igusa. On siegel modular forms of genus two. *American Journal of Mathematics*, 84(1):175–200, 1962.
- [99] Albrecht Klemm, Maximilian Poretschkin, Thorsten Schimannek, and Martin Westerholt-Raum. Direct Integration for Mirror Curves of Genus Two and an Almost Meromorphic Siegel Modular Form. Feb 2015. arXiv: 1502.00557.
- [100] Andreas Malmendier and Tony Shaska. A universal genus-two curve from siegel modular forms. *Symmetry, Integrability and Geometry: Methods and Applications*, Nov 2017.
- [101] Andreas Malmendier and Tony Shaska. The Satake sextic in F-theory. *J. Geom. Phys.*, 120:290–305, 2017.
- [102] Jun-Ichi Igusa. On the ring of modular forms of degree two over z . *American Journal of Mathematics*, 101(1):149–183, 1979.
- [103] John H. Conway and Simon P. Norton. Monstrous Moonshine. *Bull. London Math. Soc.*, 11(3):308–339, 1979.
- [104] Michael R. Douglas and Stephen H. Shenker. Dynamics of $SU(N)$ supersymmetric gauge theory. *Nucl. Phys.*, B447:271–296, 1995.
- [105] Keno Eilers. Rosenhain-Thomae formulae for higher genera hyperelliptic curves. *Journal of Nonlinear Mathematical Physics*, 25, 07 2017.
- [106] Bong H. Lian and Shing-Tung Yau. Mirror maps, modular relations and hypergeometric series 1. July 1995. arXiv: hep-th/9507151.

- [107] Murad Alim, Emanuel Scheidegger, Shing-Tung Yau, and Jie Zhou. Special Polynomial Rings, Quasi Modular Forms and Duality of Topological Strings. *Adv. Theor. Math. Phys.*, 18(2):401–467, 2014.
- [108] Basil Gordon. *Multiplicative properties of eta-products*, volume 143 of *Contemp. Math.* Amer. Math. Soc., 1993.
- [109] Ken Ono. *The Web of Modularity: Arithmetic of the Coefficients of Modular Forms and q -series*, volume 102. American Mathematical Society, CBMS Regional Conference Series in Mathematics edition, 2004.
- [110] Philip Argyres, Matteo Lotito, Yongchao Lü, and Mario Martone. Geometric constraints on the space of $\mathcal{N} = 2$ SCFTs. Part I: physical constraints on relevant deformations. *JHEP*, 02:001, 2018.
- [111] Jun-Ichi Igusa. Arithmetic variety of moduli for genus two. *Annals of Mathematics*, 72(3):612–649, 1960.
- [112] Tony Shaska and Helmut Voelklein. Elliptic subfields and automorphisms of genus 2 function fields. *arXiv Mathematics e-prints*, page math/0107142, July 2001.
- [113] Tony Shaska. Determining the automorphism group of a hyperelliptic curve. *arXiv Mathematics e-prints*, page math/0312284, December 2003.
- [114] Tony Shaska and Sujeeva Wijesiri. Theta functions and algebraic curves with automorphisms. *NATO Science for Peace and Security Series D: Information and Communication Security*, 24:193–237, 06 2009.
- [115] Wu-yen Chuang, Duiliu-Emanuel Diaconescu, Jan Manschot, Gregory W. Moore, and Yan Soibelman. Geometric engineering of (framed) BPS states. *Adv. Theor. Math. Phys.*, 18(5):1063–1231, 2014.
- [116] Dmitry Galakhov, Pietro Longhi, Tom Mainiero, Gregory W. Moore, and Andrew Neitzke. Wild Wall Crossing and BPS Giants. *JHEP*, 11:046, 2013.
- [117] Johannes Aspman, Elias Furrer, and Jan Manschot. Topological twists of massive SQCD, Part II. In preparation.
- [118] Yuji Ohta. Non-perturbative solutions to $N=2$ supersymmetric Yang-Mills theories -progress and perspective-, 1999. arXiv: hep-th/9903182.
- [119] Nikita Nekrasov and Andrei Okounkov. Seiberg-Witten theory and random partitions. *Prog. Math.*, 244:525–596, 2006.
- [120] Simon K. Donaldson and Peter B. Kronheimer. *The geometry of four-manifolds / S.K. Donaldson and P.B. Kronheimer*. Clarendon Press ; Oxford University Press Oxford : New York, 1990.
- [121] Seungjoon Hyun, Jaemo Park, and Jae-Suk Park. Spin-c Topological QCD. *Nucl. Phys.*, B453:199–224, 1995.
- [122] Jose M. F. Labastida and Marcos Marino. NonAbelian monopoles on four manifolds. *Nucl. Phys. B*, 448:373–398, 1995.
- [123] Alexei L. Gorodentsev and Maxim I. Leenson. How to calculate the correlation function in twisted SYM $N=2$, $N_f = 4$ QFT on projective plane. 4 1996.

- [124] J.A. Bryan and R. Wentworth. The multi-monopole equations for Kähler surfaces. *Turkish J. Math.*, 20:119–128, 1996.
- [125] Gregory W. Moore, Nikita Nekrasov, and Samson Shatashvili. Integrating over Higgs branches. *Commun. Math. Phys.*, 209:97–121, 2000.
- [126] Mykola Dedushenko, Sergei Gukov, and Pavel Putrov. Vertex algebras and 4-manifold invariants. In *Nigel Hitchin’s 70th Birthday Conference*, volume 1, pages 249–318, 5 2017.
- [127] Marcos Marino, Gregory W. Moore, and Grigor Peradze. Four manifold geography and superconformal symmetry. Dec 1998. arXiv: math/9812042.
- [128] Seungjoon Hyun, Jaemo Park, and Jae-Suk Park. N=2 supersymmetric QCD and four manifolds: 1. The Donaldson and Seiberg-Witten invariants. Aug 1995. arXiv: hep-th/9508162.
- [129] Paul M. N. Feehan and Thomas G. Leness. SO(3) monopoles, level one Seiberg-Witten moduli spaces, and Witten’s conjecture in low degrees. *Topology Appl.*, 124:221–326, 2002.
- [130] Andrei Losev, Nikita Nekrasov, and Samson L. Shatashvili. Issues in topological gauge theory. *Nucl. Phys.*, B534:549–611, 1998.
- [131] Varghese Mathai and Daniel G. Quillen. Superconnections, Thom classes and equivariant differential forms. *Topology*, 25:85–110, 1986.
- [132] Michael F. Atiyah and Lisa Jeffrey. Topological Lagrangians and cohomology. *J. Geom. Phys.*, 7:119–136, 1990.
- [133] Andrei Losev, Nikita Nekrasov, and Samson Shatashvili. Testing seiberg-witten solution, 1998. arXiv: hep-th/9801061.
- [134] Stefan Cordes, Gregory W. Moore, and Sanjaye Ramgoolam. Lectures on 2-d Yang-Mills theory, equivariant cohomology and topological field theories. *Nucl. Phys. B Proc. Suppl.*, 41:184–244, 1995.
- [135] Marcos Mariño, Gregory Moore, and Grigor Peradze. Superconformal invariance and the geography of four-manifolds. *Communications in Mathematical Physics*, 205(3):691–735, 1999.
- [136] Alfred D. Shapere and Yuji Tachikawa. Central charges of N=2 superconformal field theories in four dimensions. *JHEP*, 09:109, 2008.
- [137] Ann E. Nelson and Nathan Seiberg. R symmetry breaking versus supersymmetry breaking. *Nucl. Phys. B*, 416:46–62, 1994.
- [138] Clay Córdova and Thomas T. Dumitrescu. Candidate Phases for SU(2) Adjoint QCD₄ with Two Flavors from $\mathcal{N} = 2$ Supersymmetric Yang-Mills Theory. 6 2018.
- [139] Jan Manschot, Gregory W. Moore, and Xinyu Zhang. Effective gravitational couplings of four-dimensional $\mathcal{N} = 2$ supersymmetric gauge theories. Dec 2019. arXiv: 1912.04091.
- [140] Edward Witten. Supersymmetric Yang-Mills theory on a four manifold. *J. Math. Phys.*, 35:5101–5135, 1994.

- [141] Marcos Marino and Gregory Moore. Integrating over the Coulomb branch in $\mathcal{N} = 2$ gauge theory. *Nuclear Physics B - Proceedings Supplements*, 68(1):336–347, 1998. Strings '97.
- [142] Marcos Mariño. The Uses of Whitham Hierarchies. *Progress of Theoretical Physics Supplement*, 135:29–52, 1999.
- [143] Jose M. F. Labastida and Carlos Lozano. Duality in twisted $N=4$ supersymmetric gauge theories in four-dimensions. *Nucl. Phys.*, B537:203–242, 1999.
- [144] Kanehisa Takasaki. Integrable hierarchies and contact terms in u-plane integrals of topologically twisted supersymmetric gauge theories. *International Journal of Modern Physics A*, 14(07):1001–1013, Mar 1999.
- [145] Richard Borcherds. Automorphic forms with singularities on Grassmannians. *Invent. Math.* **132** (1998) 491 doi:10.1007/s002220050232, 1998.
- [146] Kathrin Bringmann, Nikolaos Diamantis, and Stephan Ehlen. Regularized inner products and errors of modularity. *International Mathematics Research Notices*, 2017(24):7420–7458, 2017.
- [147] Jan Hendrik Bruinier and Jens Funke. On two geometric theta lifts. *Duke Mathematical Journal*, 125(1):45–90, 2004.
- [148] Wolfgang Lerche, A. N. Schellekens, and Nicholas P. Warner. Lattices and Strings. *Phys. Rept.*, 177:1, 1989.
- [149] Lance J. Dixon, Vadim Kaplunovsky, and Jan Louis. Moduli dependence of string loop corrections to gauge coupling constants. *Nucl. Phys.*, B355:649–688, 1991.
- [150] Jeffrey A. Harvey and Gregory W. Moore. Algebras, BPS states, and strings. *Nucl. Phys.*, B463:315–368, 1996.
- [151] Jan Hendrik Bruinier, Gerard van der Geer, Gunter Harder, and Don Zagier. *The 1-2-3 of Modular Forms*. Springer-Verlag Berlin Heidelberg, 2008.
- [152] H. Petersson. Konstruktion der Modulformen und der zu gewissen Grenzkreisgruppen gehörigen automorphen Formen von positiver reeller Dimension und die vollständige Bestimmung ihrer Fourierkoeffizienten. *S.-B. Heidelberger Akad. Wiss. Math.-Nat. Kl.*, pages 417–494, 1950.
- [153] Andreas Malmendier and Ken Ono. $SO(3)$ -Donaldson invariants of \mathbb{P}^2 and Mock Theta Functions. *Geom. Topol.*, 16:1767–1833, 2012.
- [154] Vicente Muñoz. Wall-crossing formulae for algebraic surfaces with $q > 0$. *arXiv e-prints*, September 1997.
- [155] Marcos Marino and Gregory W. Moore. Donaldson invariants for nonsimply connected manifolds. *Commun. Math. Phys.*, 203:249, 1999.
- [156] Carlos Lozano and Marcos Marino. Donaldson invariants of product ruled surfaces and two-dimensional gauge theories. *Commun. Math. Phys.*, 220:231–261, 2001.
- [157] Michael Bershadsky, Andrei Johansen, Vladimir Sadov, and Cumrun Vafa. Topological reduction of 4d sym to 2d σ -models. *Nuclear Physics B*, 448(1-2):166–186, 1995.
- [158] Sander Pieter Zwegers. *Mock Theta Functions*. PhD thesis, 2008.

- [159] Jorge G. Russo. Properties of the partition function of $\mathcal{N} = 2$ supersymmetric QCD with massive matter. *JHEP*, 07:125, 2019.
- [160] Davide Gaiotto, Gregory W Moore, and Andrew Neitzke. Wall-crossing, hitchin systems, and the wkb approximation. *Advances in Mathematics*, 234:239–403, 2013.
- [161] Bong H. Lian and Shing-Tung Yau. Arithmetic properties of mirror map and quantum coupling. *Commun. Math. Phys.*, 176:163–192, 1996.
- [162] Babak Haghighat. Mirror Symmetry and Modularity. Dec 2017. arXiv:1712.00601.
- [163] Daniel Kläwer. Modular curves and the refined distance conjecture. *JHEP*, 12:088, 2021.
- [164] Joseph Silverman; John Tate. *Rational Points on Elliptic Curves*. Number 2 in Undergraduate Texts in Mathematics. Springer International Publishing, 2015.
- [165] Dale Husemöller. *Elliptic Curves*, volume 111 of *Graduate Texts in Mathematics*. Springer-Verlag New York, 2 edition, 2004.
- [166] Roelof W. Bruggeman. *Families of Automorphic Forms*. Birkhäuser Basel, 1994.
- [167] Keith Conrad. $SL(2, \mathbb{Z})$. URL: [https://kconrad.math.uconn.edu/blurbs/grouptheory/SL\(2,Z\).pdf](https://kconrad.math.uconn.edu/blurbs/grouptheory/SL(2,Z).pdf).
- [168] Robert A. Rankin. *Modular Forms and Functions*. Cambridge University Press, 1977.
- [169] Abdellah Sebbar. Classification of torsion-free genus zero congruence groups. *Proceedings of the American Mathematical Society*, 129(9):2517–2527, 2001.
- [170] Kunihiko Kodaira. On Compact Analytic Surfaces: II. *Annals of Mathematics*, 77(3):563–626, 1963.
- [171] Kunihiko Kodaira. On Compact Analytic Surfaces, III. *Annals of Mathematics*, 78(1):1–40, 1963.
- [172] Don Zagier. *Introduction to modular forms; From Number Theory to Physics*. Springer, Berlin (1992), pp. 238-291, 1992.
- [173] Neal Koblitz. *Introduction to Elliptic Curves and Modular Forms*. Graduate Texts in Mathematics. Springer New York, 1993.
- [174] Marie-France Vignéras. Séries thêta des formes quadratiques indéfinies. *Springer Lecture Notes*, 627:227 – 239, 1977.
- [175] Jan Stienstra and Don Zagier. Bimodular forms and holomorphic anomaly equation. Workshop on Modular Forms and String Duality, Banff International Research Centre, 2006, report: <https://www.birs.ca/workshops/2006/06w5041/report06w5041.pdf>.
- [176] Yifan Yang, Noriko Yui, et al. Differential equations satisfied by modular forms and $k3$ surfaces. *Illinois Journal of Mathematics*, 51(2):667–696, 2007.
- [177] Liuquan Wang and Yifan Yang. Ramanujan-type $1/\pi$ -series from bimodular forms. page arXiv:2003.02572, March 2020.

-
- [178] Eberhard Freitag. *Siegelsche Modulfunktionen*, volume 254 of *Grundlehren der mathematischen Wissenschaften*. Springer-Verlag Berlin Heidelberg, 1 edition, 1983.
- [179] Emma Previato, Tony Shaska, and G. S. Wijesiri. Thetanulls of cyclic curves of small genus. *arXiv e-prints*, page arXiv:1301.4595, Jan 2013.
- [180] Milton Abramowitz and Irene A. Stegun. *Handbook of Mathematical Functions with Formulas, Graphs, and Mathematical Tables*. Dover, New York, ninth dover printing, tenth gpo printing edition, 1964.