

# The use of in-situ site investigation techniques for the axial design of offshore piles

D.J.P. Igoe

University College Dublin

K.G. Gavin

University College Dublin

B.C. O'Kelly

Trinity College Dublin

B. Byrne

Carlow Institute of Technology

**KEYWORDS:** Offshore, Piles, Sand, CPT,

**ABSTRACT:**

Offshore wind turbines are typically founded on driven steel pipe piles, using either a single large monopile or multiple piles anchoring a tripod or jacket-type structure. Recent design methods for offshore driven piles have been developed based on the results of field tests using instrumented closed-ended model piles that allowed the measurement of the radial effective stress at a number of locations along the pile shaft. These measured radial stresses were then directly related to *in-situ* soil properties such as CPT cone resistance. This paper investigates the use of *in-situ* site investigation techniques, in particular the CPT, for the design of open-ended piles. A recent CPT-based design method, the UCD-11 (Igoe et al. 2011), which is based on field tests using an instrumented open-ended model pile, is applied in the present study to predict the axial tension capacity of two open-ended piles driven into a medium dense sand deposit. The accuracy of this recent method is compared with both traditional earth-pressure and other CPT based methods in order to assess its predictive performance.

## 1 INTRODUCTION

In an offshore environment, open-ended steel tubular (pipe) piles are widely used to support tripod and jacket-type structures. Because of their relatively low base resistance, open-ended piles can be driven to deep penetrations in order to mobilize sufficient resistance to tension loading. Due to the high cost of performing static load tests on offshore piles, industry remains reliant on static axial design methods (Schneider, 2006) many of which have been calibrated using results from relatively small-scale on-shore pile tests (See Gavin et al. 2011). This paper investigates the use of *in-situ* site investigation techniques such as the CPT for the design of offshore piles.

## 2 BACKGROUND

Design methods for estimating the shaft friction developed on pipe piles have been developed largely by the offshore industry and are summarized in the latest edition of the American Petroleum Institute API-RP2A (2007) design guidelines. The API method has traditionally been based on the earth pressure

approach which relates the local unit shaft friction,  $\tau_f$ , to the vertical effective stress,  $\sigma'_{v0}$ , using an empirical factor  $\beta$ :

$$\tau_f = \beta \cdot \sigma'_{v0} \quad (1)$$

where  $\beta$  ranges from 0.29 to 0.56 for medium-dense and very dense sand deposits respectively. Several studies (including Chow 1996, Lehane et al. 2005) have shown that the API method has poor reliability, typically underestimating the shaft resistance of piles in dense sand while overestimating the resistance in loose sand. In more recent API editions, the method is precluded from use in loose sands since the pile lengths obtained from the calculations were noted to be unconservative (API-2007).

Simple design methods that relate the local unit shaft friction to an *in-situ* test parameter such as the Standard Penetration Test (SPT) N-value or the Cone Penetration Test (CPT) end resistance  $q_c$  through scalar coefficients, are also widely used in practice:

$$\tau_f = \alpha \cdot q_c \quad (2a)$$

$$\tau_f = \lambda \cdot N \quad (2b)$$

where  $\alpha$  and  $\lambda$  are empirical factors. There are large variations in recommended  $\alpha$  values reported in literature depending on the pile type and soil conditions. For example, Meyerhof (1956) suggested  $\alpha = 0.005$  and  $\lambda = 2$  for closed-ended piles with  $\alpha = 0.0025$  and  $\lambda = 1$  for low-displacement piles. Eslami and Fellenius (1997) suggested  $\alpha$  values of between 0.004 and 0.010, depending on the sand type, and did not differentiate between pipe piles, concrete piles and H-piles. Based on experience from offshore piling, De Ruiter and Beringen (1979) developed an approach where  $\alpha = 0.003$ . More recently, Foye et al. (2009) suggested that  $\alpha$  increased from 0.002 for open-ended piles to 0.005 for closed-ended piles.

Dennis and Olson (1983), Lehane et al. (1994) and others have shown that the local radial effective stress at failure,  $\sigma'_{rf}$ , which controls  $\tau_f$  can be described using the Coulomb failure criterion:

$$\tau_f = \sigma'_{rf} \cdot \tan \delta_f \quad (3)$$

where  $\delta_f$  is the interface friction angle at failure.

Tests performed in sand by Lehane (1992) and Chow (1996) using the closed-ended Imperial College Pile (ICP), which allowed continuous measurement of radial effective stress, shear stress and unit end-bearing resistance ( $q_b$ ) profiles during installation and load testing, resulted in significant insights into the mechanisms governing the mobilization of radial effective stress on closed-ended piles. These tests showed that  $\sigma'_{rf}$  comprised of two discrete components, namely the radial effective stress after pile installation and equalization,  $\sigma'_{rc}$ , and the increase in stress due to dilation during loading,  $\Delta\sigma'_{rd}$ :

$$\sigma'_{rf} = \sigma'_{rc} + \Delta\sigma'_{rd} \quad (4)$$

Jardine et al. (2005) proposed a direct correlation between  $\sigma'_{rc}$  and  $q_c$ , known as the ICP-05 method. The effects of friction fatigue are considered through a geometric term,  $h/R$  (where  $h$  is the distance from the pile toe to the point under consideration and  $R$  is the pile radius):

$$\sigma'_{rc} = 0.029 \cdot q_c \cdot \left[ \max \left( \frac{h}{R}, 8 \right) \right]^{-0.38} \left( \frac{\sigma'_{v0}}{p_{ref}} \right)^{0.13} \quad (5)$$

where  $p_{ref} = 100$  kPa. Lehane et al. (2005) suggested an alternative expression for  $\sigma'_{rc}$  that is known as the UWA-05 method:

$$\sigma'_{rc} = 0.03 \cdot q_c \cdot \left[ \min \left( \frac{h}{D}, 2 \right) \right]^{-0.5} \quad (6)$$

where  $D$  is the outer pile diameter. Reduction factors are included in both the ICP and UWA methods to account for radial stress reductions that occurred during tension load tests performed using the ICP. Both the ICP-05 and UWA-05 methods include expressions to predict the stress increase caused by dilation,  $\Delta\sigma'_{rd}$ , based on the work of Lehane et al.

(1994), with  $\Delta\sigma'_{rd}$  inversely proportional to the pile diameter:

$$\Delta\sigma'_{rd} = \left( \frac{4G}{D} \right) \Delta y \quad (7)$$

where  $G$  is the operational shear modulus of the soil (which can be correlated with CPT  $q_c$ ) and  $\Delta y$  is the radial displacement occurring during pile loading ( $\approx 0.02$  mm for lightly-rusted steel piles).

Whilst Equations 5 and 6 were derived from statistical analyses of radial effective stress data obtained using the closed-ended ICP, no comparable measurements of the radial effective stress mobilized for open-ended piles were available. Any scientific consideration of the behavior of pipe piles in sand must consider the soil core development during pile installation. During driving, internal shear stresses develop as soil enters the pile bore. If these stresses become large enough, they can restrict further soil intrusion, thereby causing plugging. The development of the soil plug during installation can be described by the incremental filling ratio (IFR) or the effective area ratio ( $A_{r,eff}$ ):

$$IFR = \frac{\Delta L_{plug}}{\Delta L} \quad (8a)$$

$$A_{r,eff} = 1 - IFR \left( \frac{D_i}{D} \right)^2 \quad (8b)$$

where  $\Delta L_{plug}$  is the change in the plug length for a given penetration increment  $\Delta L$  and  $D_i$  is the internal pile diameter. Thus when a pile is fully coring IFR = 1 and when the pile is fully plugged IFR = 0.  $A_{r,eff}$  is the ratio of the volume of soil displaced to the gross pile volume and is equal to unity for a closed-ended or fully plugged pile (IFR = 0), reducing to values of typically 0.1–0.2 for fully coring piles.

Since most field-scale offshore piles are close to fully coring during driving, Jardine et al. (2005) suggested that the pile radius term in Equation 5 should be modified in order to account for the lower degree of soil displacement caused by pipe-pile installation (assuming fully coring conditions) and was adopted in ICP-05 design method as follows:

$$R^* = \sqrt{D^2 - D_i^2} \quad (9)$$

Gavin and Lehane (2003) reported experimental data which showed that the shaft resistance developed by open-ended piles jacked into loose sand increased as IFR reduced and they suggested an alternative form of Equation 5 in which the  $R$  term remained unchanged. Furthermore,  $q_c$  was replaced by the unit end-bearing resistance developed by an open-ended pile. White et al. (2005) presented cavity expansion analyses which suggested a weaker dependence on IFR from which an effective area correction factor ( $A_{r,eff}$ ) was subsequently adopted in the UWA-05 method:

$$\sigma'_{rc} = 0.03 \cdot q_c \cdot \left[ \max\left(\frac{h}{D}, 2\right) \right]^{-0.5} A_{r,eff}^{0.3} \quad (10)$$

An alternative CPT based approach known as NGI-05 was suggested by Clausen et al. (2005):

$$\tau_f = \frac{z}{L} \cdot p_{ref} \cdot F_{Dr} \cdot F_{sig} \cdot F_{tip} \cdot F_{load} \cdot F_{mat} \geq \tau_{min} \quad (11a)$$

$$F_{Dr} = 2.1 (D_r - 0.1)^{1.7} \quad (11b)$$

$$D_r = 0.4 \ln(q_{c1N}/22) \quad (11c)$$

$$q_{c1N} = (q_c/p_a) / \left( \sigma'_{v0}/p_a \right)^{0.5} \quad (11d)$$

where:

$$F_{sig} = (\sigma'_{v0}/p_{ref})^{-0.25}$$

$F_{tip}$  = 1.0 and 1.6 for driven open- and closed-ended piles respectively;

$F_{load}$  = 1.0 and 1.3 for tension and compression loading respectively;

$F_{mat}$  = 1.0 and 1.2 for steel and concrete piles respectively;

$$\tau_{min} = 0.1 \sigma'_{v0}$$

In the NGI-05 method, the CPT  $q_c$  value is incorporated through a correlation with nominal relative density. Friction fatigue is considered using a sliding triangle distribution of  $\tau_f$  against normalized pile penetration (See Toolan et al. 1990) as opposed to diameter dependant terms such as  $h/D$  or  $h/R^*$ . The pile end condition is accounted for using a fixed reduction factor for open-ended piles. It is noted that both the ICP-05 and UWA-05 methods allow the designer to input the interface friction angle  $\delta_f$  and also provide guidelines on the choice of this parameter value based on the mean particle size. However, the  $\delta_f$  parameter is included implicitly in the formulation for the NGI-05 method.

To illustrate the differences between the shear stress profiles predicted using the ICP-05, UWA-05 and NGI-05 methods, the shear stress profiles predicted for a 1.0 m diameter pipe pile, driven to a depth of 20 m into a saturated over-consolidated sand are shown in Figure 1. For simplicity, the sand of 18 kN/m<sup>3</sup> saturated unit weight was assumed to have a uniform  $q_c$  value of 10 MPa over this depth, be fully coring throughout installation and thus have an effective area ratio  $A_{r,eff} = 0.2$ . The groundwater table was assumed to be located at the ground surface. The average shaft resistance ( $\tau_{av} = \int \tau_f / \text{Area of the pile shaft}$ ) predicted for a closed-ended pile were 55, 75 and 66 kPa using the ICP-05, NGI-05 and UWA-05 methods respectively. For an open-ended pile, the  $\tau_{av}$  values were 35, 47 and 42 kPa using the

ICP-05, NGI-05 and UWA-05 methods respectively.

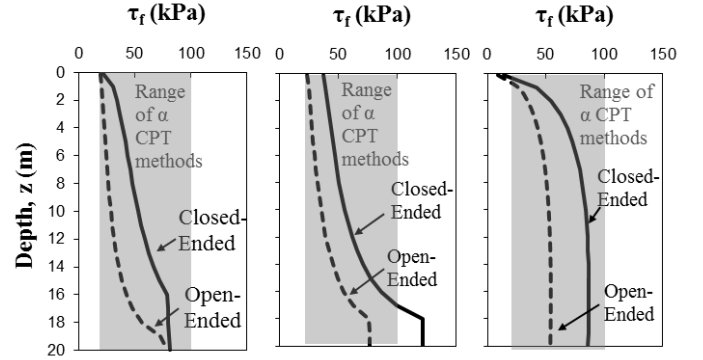

Figure 1: Shaft friction profile for a typical offshore pile using (a) ICP-05 (b) UWA-05 and (c) NGI-05 methods.

The ICP-05, NGI-05 and UWA-05 methods for open-ended pile design are fundamentally based on the results of instrumented closed-ended model piles and which have subsequently been adapted and calibrated against databases of field scale open-ended piles. Igoe et al. (2011) presented field measurements of radial effective stress mobilized during the installation and load testing of instrumented open-ended model piles. The instrumentation of the UCD open-ended model pile, which allows independent measurements of the mobilized shaft and base resistance, has been described by Igoe et al. (2008, 2010). It was found that for driven and jacked installations, the equalized radial effective stress mobilized near the pile toe was strongly dependent on the degree of plugging that had occurred during installation (quantified in terms of the IFR or  $A_{r,eff}$ ). However, it was also found that further away from the pile toe, little or no dependence existed between radial effective stress and IFR. Cyclic loading was shown to cause a reduction in the equalized radial effective stress toward a minimum threshold value, beyond which further cycling caused no further reduction to occur. It was suggested that driven piles would typically experience a large number of blows (shearing cycles) during installation and hence the end-of-driving radial stresses would be at or close to this minimum threshold value. From this research, Igoe et al. (2011) proposed a new design method, referred to as UCD-11, in order to predict  $\sigma'_{rc}$  for the end of driving condition:

$$\sigma'_{rc} = q_c \left[ 0.025 - 0.0025 \left( \frac{h}{D} \right) \right] A_{r,eff} > \sigma'_{rc,min} \quad (12a)$$

$$\sigma'_{rc,min} = \gamma q_c \quad (12b)$$

where  $\gamma$  accounts for the minimum threshold value which depends on the sand state. Tentative values of  $\gamma = 0.003$  and  $0.006$  were proposed for loose and dense sand, respectively, with higher values possible in very dense over-consolidated deposits. Figure 2 shows a comparison of the equalized radial effective stresses determined using the UCD-11 and UWA-05 design methods for a pile in dense sand. For fully

coring open-ended piles ( $A_{r,eff} \leq 0.2$ ), the UCD-11 method suggests a constant shear stress profile relative to the CPT  $q_c$ , similar to the simple ‘alpha’ CPT methods (Equation 2a). The UCD-11 tends to be more conservative than the UWA-05 for short piles (i.e.  $L/D < 15$ ) but also predicts larger capacities for slender piles (i.e.  $L/D > 40$ ).

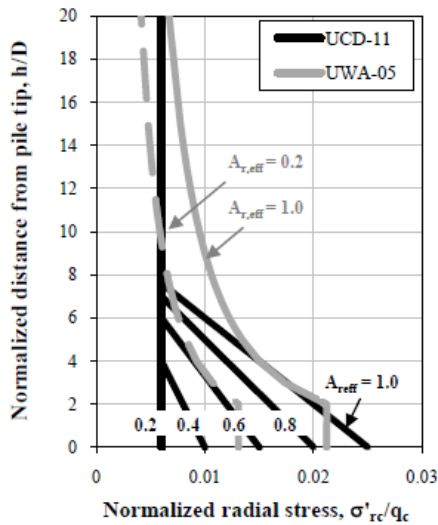

Figure 2 Comparison of the UCD-11 and UWA-05 methods for dense sand.

### 3 EXPERIMENTAL INVESTIGATION

#### 3.1 Test Site

Details of the soil stratigraphy at the Mortarstown test site (County Carlow, Ireland) were provided by a 12-m deep cable percussion borehole that was drilled approximately 2 m remote from the piling area. Standard penetration tests (SPT) N-values and grading analysis performed on the recovered borehole samples indicated a gravelly clayey silt layer to 1.2-m depth overlying a layer of medium dense sand (mean particle size,  $D_{50} = 0.22$  mm) extending to 12-m below ground level (bgl). The sand layer was inter-bedded by medium dense gravel from 6.2 to 7.2 mbgl and 11 to 12 mbgl. The ground water table is located approximately 6 mbgl. A 300-mm thick gravel hard standing was formed above ground level in order to accommodate the operation of the piling rig. Shearbox tests performed on undisturbed specimens taken from depths of 2.0 and 4.0 mbgl indicated peak friction angles,  $\phi_p$ , of  $30^\circ$  and  $35^\circ$  respectively. A second borehole installed approximately 10 m remote from the piling location indicated a sandy gravelly clay layer to 2.3 mbgl overlying gravel to 10 mbgl, illustrating the variability of the ground conditions across the test site.

*In-situ* tests performed at the site included SPTs, three CPT which provided cone end resistance ( $q_c$ ) and sleeve friction ( $f_s$ ) profiles, and Multiple Analysis of Surface Waves (MASW) which provided the small-strain shear stiffness ( $G_0$ ) profile with

depth (Figure 3). The CPTs 1, 2 and 3 were performed about 4, 2 and 10 m remote from the piling location respectively. The SPT N-values were typically between 15 and 20 (Figure 3d) with occasional high N values indicative in Irish glacial deposits of the presence of cobbles. The CPT  $q_c$  and  $f_s$  values were highly variable in the gravelly clayey silt layer to 1.2 mbgl, below which the CPT1  $q_c$  values remained consistent at  $\approx 8$  MPa, before increasing to 12–20 MPa at depths greater than 5 mbgl. The MASW  $G_0$  values ranged from 120 to 190 MPa between 1.2 and 5.5 mbgl, below which  $G_0$  increased sharply to greater than 300 MPa.

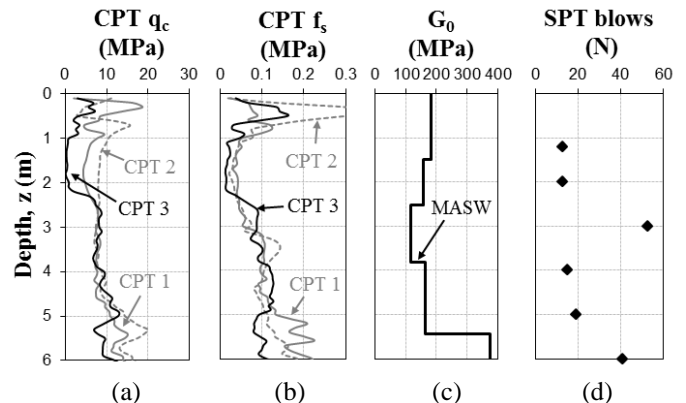

Figure 3 (a) CPT cone resistance (b) CPT sleeve friction (c) MASW shear stiffness  $G_0$  and (d) SPT Blow Count at the Mortarstown test site.

#### 3.2 Test Programme

Two identical steel open-ended piles (4.0 m in overall length, 200-mm in external diameter and 10-mm in wall thickness) were driven using a Junntan PM16 drop-hammer piling rig. The rig had a 3000 kg ram weight, a 0.8m stroke and had a maximum driving energy of 24 kNm. Driving was paused periodically in order to allow measurements of the soil plug length until the target penetration depth of 3.3 mbgl had been reached.

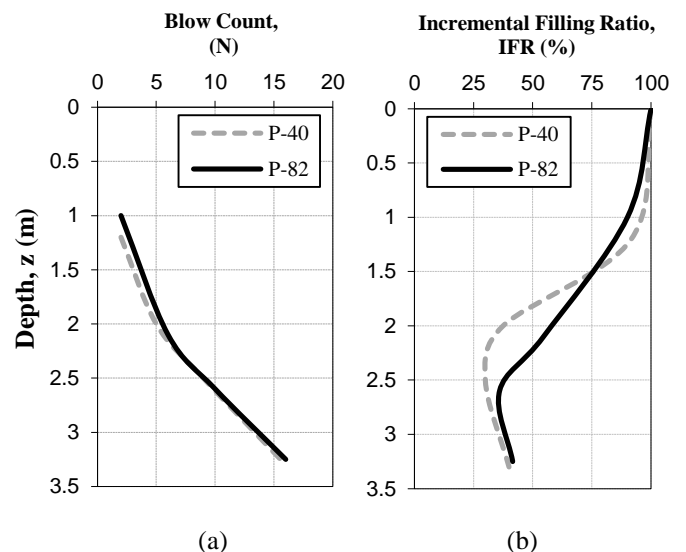

Figure 4 (a) Blow count during driving; (b) IFR response.

The blow count measurements during pile driving are shown in Figure 4a. The initial few blows produced large displacements of both piles (only two blows to reach 1.0 m penetration depth) after which the penetration per blow reduced, with a total of 18 blows imparted to reach the penetration depth of 3.3 mbgl. The IFR data were similar for both piles with full coring (IFR  $\approx$  100%) occurring to about 1.0 mbgl (onset of partial plugging) and partial plugging occurring until the end of driving at 3.3 mbgl (Figure 4b).

### 3.3 Pile Load Testing

The two piles were subjected to maintained load tests (MLTs) in tension after 40 and 82 days following installation (pile designations P-40 and P-82 respectively). The piles were loaded using a frame which spread the reaction onto ground beams that were spaced at 1.5m from the piles (Figure 5). A horizontal steel plate with a central hole was welded onto the top of the pile. A nut was welded onto the underside of this plate to accommodate a threaded bar which was used to secure the pile head to the loading hanger, thereby facilitating the application of tension forces to the pile.

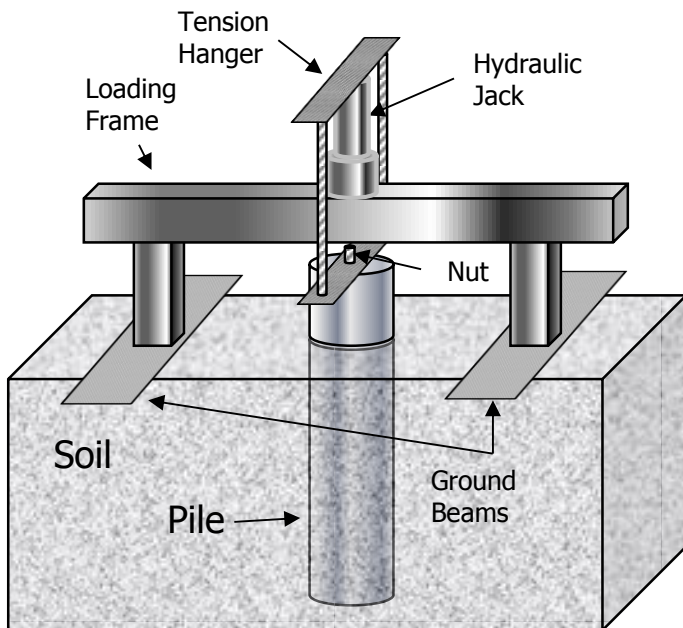

Figure 5 Setup for tension load tests.

The load-displacement curves for the two piles are shown in Figure 6. Excessive bending of the tension hanger during loading of pile P-40 resulted in the tension load test being terminated after 2.4 mm pile-head displacement without mobilizing the tension capacity. Hence, it is possible that pile P-40 was influenced by some bending/uneven loading for applied loads greater than 70 kN. The tension hanger was reinforced for the testing of pile P-82 which was subjected to a maintained-load static tension test until a displacement of 20mm (i.e. 10% of pile di-

ameter) was achieved. Pile P-82 had a slightly higher initial stiffness than P-40 but this was found to reduce sharply after  $\approx$ 1 mm of displacement (Figure 6). For pile P-82, the mobilized tension resistance continued to increase, reaching a peak capacity of 110 kN at a displacement of 20 mm.

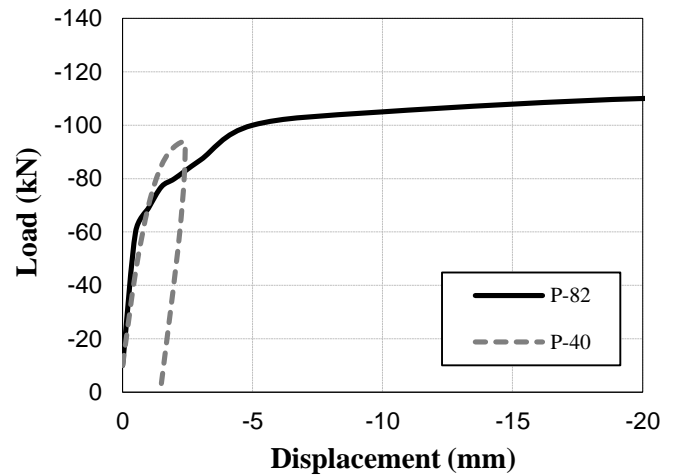

Figure 6 Load-displacement curves for instrumented tension piles at the Mortarstown site

## 4 DISCUSSION

Figure 7 shows the predictions of the tension capacity for P-82 determined using the different pile design methods presented earlier in this paper. For the purpose of calculations, the soil was assumed to have a bulk unit weight of 19 kN/m<sup>3</sup> and the tubular steel pile an interface friction angle of 32°. For the API-2007 and UCD-11 methods, the relative density,  $D_r$ , was calculated based on the correlation with CPT  $q_c$  proposed by Lunne and Christoffersen (1983):

$$D_r = 1/2.91 \ln\{q_c/[60(\sigma'_{vo})^{0.7}]\} \quad (13)$$

For all methods considered, the shear stress was calculated at intervals of 0.1 m along the pile shaft.

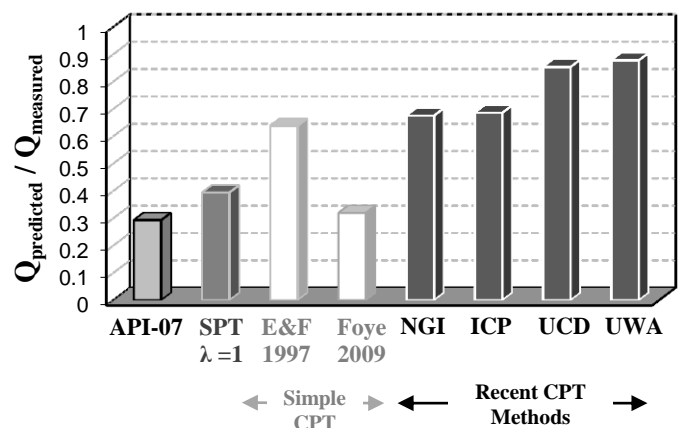

Figure 7 Comparison of design methods for pile P-82.

From Figure 7, it is evident that all of the methods considered were found to under-predict the pile



capacity in tension. The recent CPT-based methods were found to provide better estimates, with the UWA-05 and UCD-11 methods performing best for the Mortarstown tests. However, the API-07 method and the SPT-based method (after Meyerhoff, 1956) were found to grossly under-estimate the pile capacity. The simple ‘alpha’ CPT-based methods after Eslami and Fellenius (1997) and Foye et al. (2009) were also found to be less accurate to different degrees compared with the more recent CPT methods (Figure 7).

The shear stress profiles predicted by the ICP-05, UWA-05 and UCD-11 methods are compared with the traditional earth pressure based API-07 method in Figure 8. The UCD-11 method predicts higher shear stresses near the top of the pile. The UCD-11 and UWA-05 methods, both of which account for the degree of plugging during installation, also predict higher shear stresses near the pile toe than the ICP-05 method: the latter assumes that the pile is fully coring. Overall, the three CPT-based methods predicted significantly higher shear stresses along the entire pile length compared with the API-07.

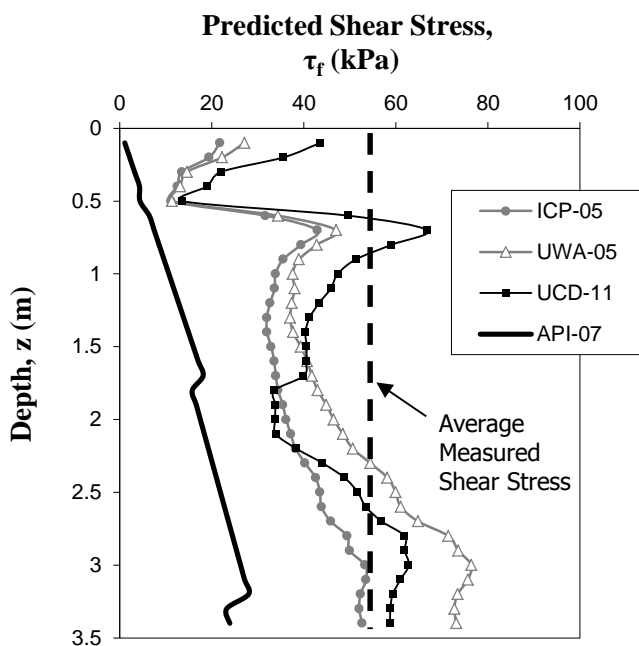

Figure 8 Comparison of predicted shear stresses for pile P-82 using earth pressure and CPT design methods.

## 5 CONCLUSIONS

The use of various *in-situ* site investigation techniques, such as the CPT and SPT, for the axial design of offshore piles was discussed. A range of design methods, based on these techniques, were used to predict the tension capacity of a driven open-ended steel pile in a medium dense sand deposit. Traditional earth pressure and SPT-based methods were found to provide the worst predictions for the particular ground conditions encountered at the Mortarstown test site, with simple ‘alpha’ CPT methods

providing marginally improved predictions. The best predictions were provided by the recent CPT based methods of NGI-05, ICP-05, UWA-05 and UCD-11 which were derived from instrumented pile tests and fundamentally capture the mechanisms controlling pile behavior. The UWA-05 and UCD-11 methods were found to provide the best predictions for the test site, which may be due, at least in part, to their ability to account for partial plugging during pile installation.

## ACKNOWLEDGMENTS

The authors would like to thank the following:

- Eddie Horkan and Terradrive piling for their help in driving the piles.
- Dave McAuley and Martin Carney in performing the CPT tests at the Carlow site;
- The Department of Civil, Structural and Environmental Engineering, Trinity College Dublin, for the use of the TCD CPT truck.
- Carlow County Council for use of the test site.
- The first author was partly funded by an RPS-MCOS Scholarship and was a recipient of post-doctoral research grants from Science Foundation Ireland (SFI) and Enterprise Ireland.

## REFERENCES

- API, 2007. Recommended Practice for Planning, Designing and Constructing Fixed Offshore Platforms – Working Stress Design. *API RP2A*. Washington, D.C., American Petroleum Institute.
- Chow, F. C., 1996. Investigations into Behaviour of Displacement Piles for Offshore Structures. PhD thesis, University of London (Imperial College).
- Clausen, C. J. F., Aas, P. M. & Karlsrud, K., 2005. Bearing capacity of driven piles in sand, the NGI approach. *Frontiers in Offshore Engineering, ISFOG*. Perth. 677–681.
- Dennis, N. D. & Olson, R. E., 1983. Axial capacity of steel pipe piles in sand. *Geotechnical Practice in Offshore Engineering*. 389–402.
- De Ruiter, J. & Beringen, F. L., 1979. Pile foundation for large North Sea structures. *Marine Geotechnology*, 3(3): 267–314.
- Eslami, A. & Fellenius, B. H., 1997. Pile capacity by direct CPT and CPTu methods applied to 102 case histories. *Canadian Geotechnical Journal*, 34(6): 886–904.
- Foye, K., Abou-Jaoude, G., Prezzi, M. & Salgado, R., 2009. Resistance factors for use in load and resistance factor design of driven pipe piles in sands. *Journal of Geotechnical and Geoenvironmental Engineering*, 135(1): 1–13.
- Gavin, K. G. & Lehane, B. M., 2003. The shaft capacity of pipe piles in sand. *Canadian Geotechnical Journal*, 40, 36–45.
- Gavin, K. G., Igoe, D. & Doherty, P., 2011. Use of open-ended piles to support offshore wind turbines: a state of the art review. *Proceedings of the Institution of Civil Engineers: Geotechnical Engineering*, 164(GE4): 245–256.

- Igoe, D., Gavin, K. G. & O'Kelly, B. C., 2011. The shaft capacity of open-ended piles in sand. *Journal of Geotechnical and Geoenvironmental Engineering*, 137(10):
- Igoe, D., Gavin, K. G. & O'Kelly, B. C., 2010. Field tests using an instrumented model pipe pile in sand. *Seventh International Conference on Physical Modelling in Geotechnics*, Zurich, Switzerland, 775–780.
- Igoe, D. J. P., Gavin, K. G. & O'Kelly, B. C., 2008. Field measurements of the base resistance of pipe piles in medium dense sand. *Second International Conference on Foundations*, Dundee, Scotland, 1, 149–158.
- Jardine, R. J., Chow, F. C., Overy, R. F. & Standing, J., 2005. ICP Design Methods for Driven Piles in Sands and Clays. Thomas Telford, London, University of London (Imperial College).
- Lehane, B. M. 1992. Experimental Investigations of Pile Behaviour using Instrumented Field Piles. PhD thesis, University of London (Imperial College).
- Lehane, B. M. & Jardine, R. J., 1994. Shaft capacity of driven piles in sand: a new design approach. *Conference on the Behaviour of Offshore Structures*. Boston, Mass. 23–36.
- Lehane, B. M., Schneider, J. A. & Xu, X., 2005. The UWA-05 method for prediction of axial capacity of driven piles in sand. *Frontiers in Offshore Geotechnics: ISFOG*. Perth. 683–689.
- Lunne, T. & Christofferson, H. P., 1983. Interpretation of cone penetrometer data for offshore sands. *Offshore Technology Conference, OTC4464*. Houston, Texas. 181–192.
- Meyerhoff, G. G., 1956. Penetration tests and bearing capacity of cohesionless soils. *Journal of the Soil Mechanics and the Foundations Division*, 82(SM1): Paper 886, 819.
- Paik, K. H. & Lee, S. R., 1993. Behaviour of soil plugs in open-ended model piles driven into sands. *Marine Georesources and Geotechnology*, 11, 353–373.
- Schneider, J. A., 2006. Impact of offshore site investigation practice on reliability of axial pile design in siliceous sands. *31st Annual Conference on Deep Foundations*. 623–638.
- Toolan, F. E., Lings, M. L. & Mirza, U. A., 1990. An appraisal of API RP2A recommendations for determining skin friction of piles in sand. *22nd Offshore Technol. Conf.* Houston, Tex. 33–42.
- White, D. J., Schneider, J. A. & Lehane, B. M., 2005. The influence of effective area ratio on shaft friction of displacement piles in sand. *Frontiers in Offshore Geotechnics, ISFOG*. University of Western Australia, Perth.