



## **Terms and Conditions of Use of Digitised Theses from Trinity College Library Dublin**

### **Copyright statement**

All material supplied by Trinity College Library is protected by copyright (under the Copyright and Related Rights Act, 2000 as amended) and other relevant Intellectual Property Rights. By accessing and using a Digitised Thesis from Trinity College Library you acknowledge that all Intellectual Property Rights in any Works supplied are the sole and exclusive property of the copyright and/or other IPR holder. Specific copyright holders may not be explicitly identified. Use of materials from other sources within a thesis should not be construed as a claim over them.

A non-exclusive, non-transferable licence is hereby granted to those using or reproducing, in whole or in part, the material for valid purposes, providing the copyright owners are acknowledged using the normal conventions. Where specific permission to use material is required, this is identified and such permission must be sought from the copyright holder or agency cited.

### **Liability statement**

By using a Digitised Thesis, I accept that Trinity College Dublin bears no legal responsibility for the accuracy, legality or comprehensiveness of materials contained within the thesis, and that Trinity College Dublin accepts no liability for indirect, consequential, or incidental, damages or losses arising from use of the thesis for whatever reason. Information located in a thesis may be subject to specific use constraints, details of which may not be explicitly described. It is the responsibility of potential and actual users to be aware of such constraints and to abide by them. By making use of material from a digitised thesis, you accept these copyright and disclaimer provisions. Where it is brought to the attention of Trinity College Library that there may be a breach of copyright or other restraint, it is the policy to withdraw or take down access to a thesis while the issue is being resolved.

### **Access Agreement**

By using a Digitised Thesis from Trinity College Library you are bound by the following Terms & Conditions. Please read them carefully.

I have read and I understand the following statement: All material supplied via a Digitised Thesis from Trinity College Library is protected by copyright and other intellectual property rights, and duplication or sale of all or part of any of a thesis is not permitted, except that material may be duplicated by you for your research use or for educational purposes in electronic or print form providing the copyright owners are acknowledged using the normal conventions. You must obtain permission for any other use. Electronic or print copies may not be offered, whether for sale or otherwise to anyone. This copy has been supplied on the understanding that it is copyright material and that no quotation from the thesis may be published without proper acknowledgement.



# Elements of an Operator Calculus

Arthur Hughes

University of Dublin,  
Trinity College, Dublin, Ireland

June 1, 2001

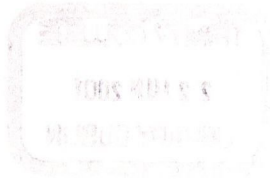

This thesis is submitted for the Ph.D. in Computer Science at the University of Dublin, Trinity College, Department of Computer Science, wherein the research was conducted.

## Declarations

I, the undersigned, declare that this thesis has not been submitted to this or any other university.

I declare that all of the material contained in this thesis, unless otherwise stated, is entirely my own work.

I declare my consent to the library of Trinity College, Dublin, that I agree that the library may lend or copy this thesis upon request.

Signature Arthur Hughes Date 6 / 6 / 01

## Dedication

This thesis is dedicated to my family:

my mother, *Valerie*,

my father, *Brendan*,

and my brother, *Paul*,

who have constantly supported me.



## Summary

The operational calculus developed by the Irish School of the Vienna Development Method (VDM) has a life of its own independent of its applications. This thesis is interested in the operational calculus that arose from the modelling of information systems. One was not overly interested in the models themselves but in the operational calculus itself. The time one has invested in the analyses and development of the operational calculus has had the following results:

- (i) Refined and improved the operational calculus of the Irish School of the VDM.
- (ii) Altered the philosophy of the Irish School of the VDM by encouraging a shift away from a pure constructive approach that allowed the embracing of the totality of mathematics.
- (iii) Categorical semantics for partial map override in terms of topos theory.
- (iv) Refined the algebraic foundations of the operational calculus of the Irish School of the VDM with the result that operator identities that were not classified originally are now classified.

The Irish School of the VDM has developed down many roads over the past seven years and one believes that one has contributed significantly to developing the operational calculus.

## Acknowledgements

I am deeply indebted to my supervisor, Dr. Mícheál Mac an Airchinnigh, who has acted not only as an insightful supervisor, but also as an inspiring academic mentor. I am grateful for the abundance of time that he has invested in me. The times that we have spent in numerous discussions, on mathematics and the role of an academic within a university have been invaluable to my development. Throughout these discussions he has instilled in me a love for mathematical reasoning and a respect for the idea of a university as a place which allows free critical thinking and teaching. His flamboyant presentation style is captivating and enables him to discuss many interrelated topics with surprising clarity. He teaches mathematics as a subject which is alive and continually growing. Indeed, his lectures, long ago, reawakened my interest in mathematics. His generosity and charm towards others is encouraging. This has been highlighted in our companionship over the last six years. His enjoyment of life is refreshing and is responsible for developing my taste in fine wines and good food. In short,

**‘Thanks Mícheál for shouting!’**

I would like to thank Dr. Andrew Butterfield for introducing me to the Irish School of the VDM and for his support and friendship throughout the past six years. Additionally, I would like to acknowledge Alexis Donnelly for starting me on the road to publications by coauthoring a number of joint papers. Indeed, I would look forward to continuing this fruitful relationship. I would like to thank the past and present members of the Foundations and Methods research group in the department of Computer Science for listening to and commenting on many preliminary ideas.

Professor David J. Simms and the School of Mathematics also receives my thanks for allowing me to participate in their undergraduate curriculum. This has enabled me to fulfill a lifelong desire to comprehend mathematics and has given me the mathematical maturity required to write this thesis.

Thanks must be given to Glenn Strong for his invaluable help with my teaching responsibilities which has given me the time required to finish this thesis. Additionally, I would like to thank John McKeown and Benjamin Jung for their teaching support.

Professor John G. Byrne must be thanked for his understanding and his belief in me as an academic.

I would like to acknowledge that Professor F. William Lawvere's writings and perspectives on topos theory has inspired aspects of this thesis.

Finally, I would like to thank my brother, Paul Hughes, for helping me express my thoughts on paper. You will never be "just another brick in the wall" (Pink Floyd).



# Contents

<b>1</b>	<b>Introduction</b>	<b>1</b>
1.1	Origin of the Irish School of the VDM . . . . .	4
1.2	Development of the Irish School of the VDM . . . . .	8
1.2.1	Modelling Advances . . . . .	9
1.2.2	Extensions to Operator Calculus . . . . .	11
1.2.3	Duality of Algebra & Geometry . . . . .	12
1.2.4	Categorical and Topos Theoretical Foundations . . . . .	14
1.3	Chapter Overview . . . . .	17
1.3.1	Indexed Operations & Operators . . . . .	18
1.3.2	Categorical Definition of Override . . . . .	19
1.3.3	Algebraic Foundations Reconsidered . . . . .	20
<b>2</b>	<b>Indexed Operations &amp; Operators</b>	<b>22</b>
2.1	Seeds of Indexed Operations . . . . .	24
2.2	Indexed Monoid Theorem . . . . .	30
2.3	Indexed Operators . . . . .	34
2.4	Indexed Operator Theorem . . . . .	38
2.5	Free Operators & Indexed Towers . . . . .	42

2.6	Dáil Model . . . . .	44
2.7	Two Types of Indexed Monoids Identified . . . . .	46
2.8	Two Types of Indexed Monoids Verified . . . . .	48
2.8.1	Indexed Structures Without Units . . . . .	50
2.8.2	Indexed Structures with Units . . . . .	55
2.9	Summary . . . . .	71
<b>3</b>	<b>Categorical Definition of Override</b>	<b>73</b>
3.1	Determination and Choice Problems . . . . .	76
3.2	Override depends on Shape . . . . .	77
3.3	Overriding Continuous Partial Maps . . . . .	80
3.4	Elementary Definition of Operators . . . . .	87
3.4.1	Partial Maps . . . . .	88
3.4.2	Extension . . . . .	88
3.4.3	Restriction . . . . .	90
3.4.4	Removal . . . . .	91
3.4.5	Override . . . . .	93
3.5	Topos of Endomaps of Sets . . . . .	93
3.6	Topos of Mappings between Sets . . . . .	112
3.7	Summary . . . . .	131
<b>4</b>	<b>Algebraic Foundations Reconsidered</b>	<b>132</b>
4.1	Algebraic Foundations Reconsidered . . . . .	133
4.1.1	Inner Laws . . . . .	135
4.1.2	Inner Law Morphisms . . . . .	138
4.1.3	Inner Law Endomorphisms . . . . .	146

4.1.4	Outer Laws . . . . .	151
4.1.5	Outer Law Morphisms . . . . .	152
4.1.6	Monoids . . . . .	167
4.1.7	Monoid Morphisms . . . . .	168
4.1.8	Monoid Endomorphisms . . . . .	176
4.1.9	Outer Law Monoids . . . . .	179
4.2	Summary . . . . .	182
<b>5</b>	<b>Conclusion</b>	<b>183</b>
5.1	Achievements . . . . .	184
5.2	Directions for Future Research . . . . .	187
<b>A</b>	<b>Partial Maps &amp; Operators</b>	<b>190</b>
A.1	Partial Maps . . . . .	191
A.2	Partial Map Operators . . . . .	191
A.2.1	Domain . . . . .	191
A.2.2	Codomain . . . . .	192
A.2.3	Application . . . . .	192
A.2.4	Range or Image . . . . .	192
A.2.5	Extension . . . . .	192
A.2.6	Removal . . . . .	193
A.2.7	Restriction . . . . .	194
A.2.8	Glueing . . . . .	194
A.2.9	Intersection . . . . .	195
A.2.10	Override . . . . .	195
A.2.11	Inverse Image . . . . .	196



A.2.12	Direct or Existential Image . . . . .	197
A.2.13	Universal Image . . . . .	197
A.2.14	Range Removal . . . . .	198
A.2.15	Range Restriction . . . . .	199
A.2.16	Partial Map Composition . . . . .	200
A.3	The phom Functor . . . . .	201
<b>B</b>	<b>Category &amp; Topos Theory</b>	<b>207</b>
B.1	Possible Map Properties . . . . .	208
B.1.1	Isomorphism . . . . .	208
B.1.2	Section and Choice Problem . . . . .	208
B.1.3	Epimorphism . . . . .	209
B.1.4	Retraction and Determination Problem . . . . .	209
B.1.5	Inclusion or Monomorphism . . . . .	210
B.1.6	Idempotent . . . . .	210
B.2	Universal Mapping Properties . . . . .	211
B.2.1	Terminals . . . . .	211
B.2.2	Initials . . . . .	211
B.2.3	Products . . . . .	212
B.2.4	Pullbacks or Fibered Products . . . . .	212
B.2.5	Sums . . . . .	214
B.2.6	Equalizers . . . . .	215
B.2.7	Coequalizers . . . . .	216
B.2.8	Map Objects . . . . .	216
B.2.9	Truth-Value Object or Subobject Classifier . . . . .	217

B.3 Parts of an Object: Toposes . . . . . 219

B.3.1 Categories  $\mathcal{C}/X$  and  $\mathcal{P}(X)$  . . . . . 219

B.3.2 Toposes and Logic . . . . . 220

# Chapter 1

## Introduction

“[T]he Irish School of the [Vienna Development Method (VDM)] may be considered to be a branch of constructive mathematics that is of interest in its own right. Thus, just as practical scientific problems led to the formulation of partial differential equations the solution of which, in turn, “created the need for mathematical developments in the theory of functions, the calculus of variations, series expansions, ordinary differential equations, algebra, and differential geometry” (Kline 1972, 19), so the application of the Irish School of the VDM is opening up a whole new branch of constructive mathematics. In other words, there is a perspective of the School that has *overtly* nothing to do with the specification, design and implementation of systems.” (Mac an Airchinnigh 1991, 142)

The constructive mathematics developed by the Irish School of the VDM has a life of its own independent of its applications. This is similar to developments in mathematics when attempts to solve partial differential equations led to the



creation of new independent branches of mathematics. This thesis is interested in the mathematics that arose from the modelling of information systems. One is not overly interested in the models themselves but the mathematics itself.

In order to place the mathematics, discussed in this thesis, in context one will compare, here, the modelling of physical systems using differential and integral equations (classical engineering) to the modelling of information systems using partial maps and operators on partial maps (Irish VDM engineering) [see appendix A for a summary of partial map operators]. This proposed comparison is summarized in Figure 1.1.

Just as the differential or integral equation of a given model of a physical system can be reused to model other physical systems, so can a model of a given information system, expressed in terms of partial maps and operators, be reused to model other information systems.

Physical systems in general are continuous whereas information systems are discrete. Hence the mathematics used to model each will differ. The language used to express models of physical systems consists of differential and integral equations, whereas the language used to express models of information systems consists of partial maps and partial map operators.

In order to understand the behavior of a physical system one must solve the differential or integral equations which are representing the physical system. In analogy to this one must analyse the partial maps and partial map operators which represent an information system to verify that they express the correct behavior of the information system. In each case an operator calculus will assist each process.

An operator calculus allows:

- (i) freedom from returning to foundational aspects,
- (ii) one is freed from always having to think about what one is doing, and
- (iii) allows reuse and cataloguing of properties in the solving of different though related problems.

Heaviside was successful in developing an operator calculus to solve differential and integral equations [see Courant (1962) for a summary of Heaviside's method of operators]. Corresponding, the Irish School of the VDM developed an operator calculus that allows one to reason about partial maps and operators [see chapter 4 for a comprehensive guide to the Irish School's operator calculus for partial map operators]. Specifically, the operator calculus of the Irish School of the VDM:

- (i) assists the formal refinement of an abstract model down to a concrete executable model, and
- (ii) assists in verification that the operators on models, at a given refinement level, are property preserving.

The Heaviside operator calculus allows the user to solve the differential or integral equations using simple algebra, where as, the operator calculus of the Irish School of the VDM uses the algebra of monoids and morphisms to analyse the behavior of partial maps and partial map operators.

A *monoid*, denoted  $(S, *, v)$ , is a non-empty set  $S$  provided with a binary operator  $*$  which is everywhere defined, associative and which has an identity element  $v$ .



A *monoid morphism*  $m$  from the monoid  $(R, *, u)$  to the monoid  $(S, *, v)$ , denoted  $(R, *, u) \xrightarrow{m} (S, *, v)$ , is a map  $R \xrightarrow{m} S$  which preserves the monoid structure, that is, for all  $r_1, r_2 \in R$ ,

$$\begin{aligned}m(r_1 * r_2) &= m(r_1) * m(r_2), \\m(u) &= v.\end{aligned}\tag{1.1}$$

The Heaviside operator calculus is given a concrete foundation using complex analysis. Heaviside's operator calculus is subsumed, today, in modern functional analysis. Similarly, can the operator calculus of the Irish School of the VDM be given a foundation in an appropriate mathematical world?

Elements of this operator calculus, from the Irish School of the VDM are considered, expanded and challenged in this thesis.

## 1.1 Origin of the Irish School of the VDM

The Vienna Development Method (VDM) is used to systematically develop software systems. The origins of the VDM come from the problem of trying to systematically develop a compiler for the PL/1 programming language. The scientific decisions taken in the design of the VDM are discussed by Jones (1999).

There is an agreement as to what constitutes the VDM. However, there are different views held on the following:

- (i) notation,
- (ii) the style of use and development, and
- (iii) the mathematical philosophy.

	<i>Classical Engineering</i>	<i>Irish VDM Engineering</i>
<i>Models</i>	physical systems	information systems
<i>Expressed</i>	differential and integral equations	partial maps and operators
<i>Solved</i>	Heaviside's operator calculus	Irish VDM operator calculus
<i>Algebra</i>	simple algebra	monoids and morphisms
<i>Foundations</i>	complex analysis	category and topos theory

Figure 1.1: Comparison between classical engineering and Irish VDM engineering.

These differing views have led to the formation of four Schools of the VDM:

- (i) the Danish School, named after Dines Bjørner,
- (ii) the English School, named after Cliff Jones (1986, 1987),
- (iii) the Polish School, named after Andrzej Blikle (1987, 1988, 1990), and
- (iv) the Irish School, named after Mícheál Mac an Airchinnigh (1987, 1990, 1991).

Each of the Schools refer to a person rather than national regions.

If one were to pin down the essential distinction between the Schools, then the Irish School would be distinguished by its philosophy. To understand the founding



philosophy of the Irish School the following quotation is noteworthy:

“[The mathematical language of the VDM] is to be used, not for solving algorithmic problems (on a computer), but for specifying, in an implementation-independent way, the architecture (or models) of software. Instead of using informal English mixed with technical jargon, we offer you a very-high-level ‘programming’ language. We do not offer an interpreter or compiler for this [mathematical language]. And we have absolutely no intention of ever wasting our time trying to mechanize this [mathematical language]. We wish, as we have done in the past, and as we intend to continue doing in the future, to further develop the notation and to express notions in ways for which no mechanical interpreter system can ever be provided.” (Bjørner and Jones 1978, 33)

The mathematical language of the VDM was not intended for solving algorithmic problems, it was intended to be used to express models of software in an implementation-independent form. In addition, there was no intention to mechanize this mathematical language. Finally, the mathematical language should be extended by notations and notions which assist in the design of models of software.

The above principles formed the founding philosophy of the Irish School of the VDM except it was also demonstrated that the mathematical language of the VDM was suitable for the expression of algorithmic problems. This allows algorithms to be expressed in a machine independent form, similar to the form of modern functional programming languages.



An additional principle of the Irish School of the VDM was to ensure that it was accessible to engineers in teaching and in usage. This principle influenced the development of the operator calculus of the Irish School to assist proof and reasoning. Seeking an operator calculus led the Irish School to algebraic relationships and not logical relationships — logic was down played and algebraic structure was embraced. If logic was to be used it must be constructive logic.

Seeking an operator calculus required the School to find algebraic structure and relationships with the result that the modelling operators were found to have monoid structure and were related to each other by monoid morphisms, including endomorphism and admissible morphisms [see Mac an Airchinnigh (1990, 104, 128) or Papy (1964, 93, 160) for the definition of an endomorphism and for the definition of an admissible morphism]. Thus, monoids and morphisms give the semantics to the modelling operators. Therefore, modelling structures and modelling operators have their expected classical mathematical meaning. Hence, the syntax and semantics of the School are the same. This has the benefit of allowing the School to continually develop in notions and concepts as classical mathematics is easily extendable, whereas, if the School had a formal semantics, then each new notion or concept would require a meaning within the formal semantics.

The School sought to find an algebra of operators without requiring operator evaluation at a point. The School strives to conduct proofs using a point free style which will in turn extend the operator calculus of the School.

As engineers are familiar with maps as opposed to relations the Irish School relied on partial maps for modelling and not relations. If relations were required they were represented as set-valued partial maps. Furthermore, engineers are familiar with equational reasoning — the substitution of one equal expression with

another equal expression — this approach to reasoning was adopted by the Irish School.

The School sought to find standard models which continually reappear in information systems. Awareness of these standard models allows an engineer to have a collection of existing models which may be altered or reused when examining a new model of an information system.

The School embraced a terse mathematical notational style. This supports the identification of theorems, assists proofs, and eases the identification of general standard models in widely varying systems.

A minimum amount of category theory was chosen as again it was believed that for engineers it would be too complex in its entirety. Specifically, category theory was used to:

- (i) express the domain equations of models and their associated maps that ‘iterate’ over the domain,
- (ii) to express the notion of refinement using a commuting diagram, and
- (iii) an adjoint relationship underlies the notion of currying which encouraged the creation of the operator calculus of the School, and
- (iv) an adjoint relationship underlies the notion of free monoid which is used by the School to express recursive functions over lists.

## 1.2 Development of the Irish School of the VDM

The historical and conceptual developments of the Irish School, after Mac an Airchinnigh’s doctoral dissertation, can be divided into four categories:



- (i) modelling advances,
- (ii) extensions to the operator calculus,
- (iii) the duality of algebra and geometry within the Irish School, and finally
- (iv) the categorical and topos theoretical foundations.

### 1.2.1 Modelling Advances

Modelling developments within the Irish School can be divided into four categories:

- (i) standard development steps,
- (ii) modelling world systems,
- (iii) reexamination of existing models, and
- (iv) developing new models.

Mac an Airchinnigh (1991) developed four ways to elaborate a model. These standard development steps are as follows:

- (i) partitioning or subdividing,
- (ii) splitting,
- (iii) parameterizing, and
- (iv) joining.



These standard development steps are mathematical transformations to elaborate a model. The elaborate model will yield insights into the original model. Additionally, these standard development steps in hindsight are intimately related to the categorical and topos theoretical foundations of the School. This view is supported by Lawvere (1976, 123–4).

O'Regan (1997) definitively demonstrated within his doctoral dissertation, that the Irish School, and indeed formal methods in general, may be used to model world systems — which are not intended to be developed into a computer system. This viewpoint is the most significant development within the School's modelling philosophy. O'Regan formally encodes social rules which up until this point have been informal. In addition to O'Regan's work on formalizing social rules for world systems, Mac an Airchinnigh (1995, 1998) included this theme within a number of final year undergraduate B.A. (Mod.) Computer Science 4BA1 Part II examination papers at the University of Dublin, Trinity College.

The School naturally continues to reexamine existing models, which it has developed, in order to simplify them. All of these reexamined models arose within Mac an Airchinnigh (1990). These reexaminations include:

- (i) the Bill of Materials by Mac an Airchinnigh (1991), O'Regan (1995) and Farrell (1997),
- (ii) the File System by O'Regan (1997), and
- (iii) the Hash Table by Hughes (1997a).

In addition the School creates new models, not only of world systems but also of standard computer systems. Butterfield (1993) gives an example of a new model of fault-tolerant hardware system using the Irish School of the VDM.

## 1.2.2 Extensions to Operator Calculus

One's own work has mostly focused on extending the operator calculus and securing the algebraic foundations of the operator calculus. The operator calculus was significantly extended by the development of indexed operations and operators [see chapter 2 for the historical and conceptual development of this indexed algebra].

In addition the operator calculus was extended when one considered the interactions of operations and operators on partial maps. This in turn led one to refine the algebraic foundations of the School, from monoids and monoid morphisms to inner laws and inner law morphisms, and outer laws and outer law morphisms [see chapter 4 for the reconsidered algebraic foundations].

Throughout the recent history of the School specific steps have helped to extend the operator calculus, including the following:

- (i) The Indexed Monoid Theorem identified by Mac an Airchinnigh (1993).
- (ii) The interaction of the inverse map operator and the partial map override operation identified by Mac an Airchinnigh (1993).
- (iii) The outer laws for Indexed Monoids identified by Hughes (1994).
- (iv) The monoid of inverse partial maps identified by Hughes (1997b).
- (v) The additional removal and restriction algebra identified by Hughes (1997a).
- (vi) The interaction of the partial map override operation and the partial map composition operation identified by Hughes and Donnelly (1997).



(vii) The reconsidered algebraic foundations for partial map operators by Hughes (2000a).

Mac an Airchinnigh (1990) within his doctoral dissertation considered the interaction of the domain operator and the removal operator, and additionally the interaction of the domain operator and the restriction operator. However Mac an Airchinnigh did not identify the interaction of the range operator with both the removal operator and restriction operator. One was asked to consider this interaction in 1995. This question was to be answered indirectly.

In 1996 one was striving to understand the categorical concept of adjunction. After reading Pierce (1988) and Barr and Wells (1995) one was exposed to the operators  $\forall_f S$  and  $\exists_f S$  [using Mac Lane and Moerdijk's (1992, 58) notation for these operators]. These operators were the key in 1998 to discovering how the range operator interacts with both the removal operator and restriction operator [see chapter 4 for the expressions of these interactions].

### 1.2.3 Duality of Algebra & Geometry

“I would dearly like to exhibit a ‘geometry’ of formal specifications;  
this has eluded me so far.” (Mac an Airchinnigh 1990, 91)

Mac an Airchinnigh was aware of Descartes' cartesian duality, and hence sought to find the geometry corresponding to the algebra within a formal specification. A geometrical perspective on a formal specification may yield additional insights, as one may be able to see connections between properties of the formal specification, connections which are apparent geometrically yet obfuscated algebraically.

Some progress has been made in the direction of seeking a geometry corresponding to the algebra within a formal specification. One can categorize the key steps in the following way:

- (i) introduction to the bundle conceptual view of a map,
- (ii) remodelling of the Hash Table as a trivial fiber bundle, and
- (iii) formal specification viewed as variable sets.

Each step is an abstraction of the previous step.

The introduction of the bundle conceptual view of a map was brought to the School's attention by Goldblatt (1984, 88–96). This was to give the School another perspective on a map in addition to the sampling perspective. The bundle perspective and the sampling perspective of a map each have an associated diagrammatic representation. One notes that Lawvere and Schanuel (1997, 81–3) also highlight these two perspectives of a map: the bundle perspective which is called sorting or stacking, and the sampling perspective which is called naming or parameterizing.

The bundle conceptual view of a map captures the notion of partition, and as many formal specifications of information systems contain partition constraints, the bundle conceptual view of a map gives a geometric perspective to the partition constraints within formal specifications. As a tool for reasoning about the behavior of operators on partial maps the bundle perspective was extremely useful for the School.

Mac an Airchinnigh (1990, 386–97) developed a model of a Hash Table and in 1996 the School reconsidered this model. One remodelled the Hash Table from an



algebraic perspective (Hughes 1997a), which in turn inspired Mac an Airchinnigh to find a geometric model. This is an example of how one's own work has been inspirational to further development of the School. The model which he produced had a geometric basis, that of, a trivial fiber bundle (Mac an Airchinnigh and Hughes 1997). An open question which remains within the School is to find a formal specification which corresponds to a non-trivial fiber bundle.

In 1999 one remodelled, using the bundle perspective of a map and the categorical concept of fibered product, a number of models which involved partition constraints. The resulting models were fibered spaces. One achieved a fibering of the state space of each of the models, this corresponded to Casti's (1997, 32–4) view on fibering of a state space. One noted that these fibered spaces were particular examples of Lawvere's (1976) concept of a *variable set*. One believes that the geometry, which corresponds to a formal specification, is a type of variable set. One demonstrated that the fibered spaces, which are a type of variable set, match the formal specifications of partitioned systems. Goguen (1992) models systems as sheaves. As sheaves are a type of variable set, this supports the direction the School has moved towards.

Above, one has described the seeking of geometry corresponding to formal specifications. Butterfield (1998) also seeks a geometry. However he seeks a geometry corresponding to algorithms.

#### 1.2.4 Categorical and Topos Theoretical Foundations

A minimum amount of category theory was initially used within the Irish School of the VDM. However, this was to be reconsidered in 1995 when Mac an Airchin-

nigh examined a Habilitationsschrift by Schewe (1995). This event was to have immense impact on the School. In order for Mac an Airchinnigh to examine this Habilitationsschrift he had to re-familiarize himself with category theory and more importantly to comprehend topos theory. This in turn exposed the School to Goldblatt (1984) and Johnstone (1977). In 1995 Mac an Airchinnigh was led to ask the question:

**“Can one give a categorical definition of override?”**

One accepted this research direction and in 1997 one presented two papers which in hindsight were the beginnings of considering override in other worlds. Both papers dealt with specialized overrides:

- (i) alias preserving overrides (Hughes and Donnelly 1997), and
- (ii) override in a world of connected dynamically evolving agents (Hughes and Pahl 1997).

Considering a concept, such as override, in other worlds leads one to topos theory, as a topos is a mathematical universe in which a mathematical concept may be interpreted.

As override depends on removal and extension, the challenge was to define removal and extension categorically. To define extension categorically was not problematic. However, to define removal categorically was problematic. The key to solving this problem was through topos theory.

The next step in this research direction occurred in 1997 when the School read Lawvere’s (1976) paper on ‘Variable Quantities and Variable Structures in Topoi’. This paper proved to be highly influential to the School for the following reasons:



- (i) Lawvere's belief that topos theory provides an alternative foundation, than that of set theory, for mathematics. Hence, as the School's semantics are mathematical, topos theory must provide a foundation for the School.
- (ii) Models in the School are collections of internally developing partial maps. This is similar in concept to that of a set which internally develops, that is, Lawvere's concept of a *variable set*.
- (iii) Lawvere's modelling philosophy is similar to the School's modelling philosophy — that of asking questions and seeing if the questions can be answered in terms of the model. However, Lawvere highlighted the fact that the answers to the questions asked additionally depended upon topos theoretical properties. This again suggests that topos theory must underlie the School as it impacts upon the modelling philosophy.

One's own paper (Hughes 1998), entitled 'Towards an Override in Topoi', was the beginning of a topos theoretical definition of override. This in turn began to answer the above question posed by Mac an Airchinnigh in 1995. This paper considered the concept of partial map override in mathematical worlds other than the mathematical world of sets and maps [see chapter 3 for a refinement of this paper].

A topos has a natural logic, that of typed intuitionistic logic, which in turn is constructive logic. This is of interest to the School for two reasons:

- (i) it reinforces the constructive philosophy of the School, and
- (ii) it at once presents the School with the possibility of developing an intuitionistic logical foundation.

Lawvere and Schanuel's (1997) book, entitled 'Conceptual Mathematics', has considerably influenced the School. Specifically:

- (i) the diagrammatic style inspired and clarified one's reasoning in the above paper on a topos theoretical definition of override,
- (ii) the modelling philosophy was again similar to the School's modelling philosophy and in addition to the formal methods community in general. However, it was missing the key notion of override or update;
- (iii) finally from a pedagogical perspective one believes that Lawvere and Schanuel's presentation of categorical and topos theory concepts are accessible to Junior Freshmen engineering and computer science students.

The Irish School has now turned full circle and re-embraced category theory including topos theory. One realizes that Lawvere's work has much to add to the School and vice versa.

### 1.3 Chapter Overview

"It is only the algebra [for the purpose of classification, comparison, and combination of programming languages] that captures the essence of the concepts at an appropriately high level of abstraction. It is perhaps for the same reason that algebraic laws are also the most useful in practice for engineering calculation.

The primary role of algebraic laws is recognized in the most abstract of branches of algebra, namely category theory. Categories provide an



excellent source of elegant laws for programming. Its objects nicely represent the types of a programming language, and its basic operation of composition of arrows is a model for the combination of actions evoked by parts of a program.” (Hoare 1999, 25–6)

The developments which one has contributed to the Irish School of the VDM over the past six years are in line with the above opinion. Indeed one’s own work falls within the above two related views:

- (i) extensions to the operator calculus of the School; this is the defining of algebraic laws referred to within the first paragraph, and
- (ii) the topos theoretical foundations of the School; this is the striving for greater abstraction through category theory and topos theory, referred to within the second paragraph.

### 1.3.1 Indexed Operations & Operators

In chapter 2, entitled ‘Indexed Operations & Operators’, the operator calculus is extended and the constructive philosophy of the School is expanded by embracing classical mathematics. Specifically one:

- (i) Records the historical development of indexed operations and operators.
- (ii) Classifies operators on indexed monoids and identifies their algebra.
- (iii) States that there are two types of indexed monoids and records their origins.
- (iv) Proves, using a classical approach, the monoidal properties of each type of indexed monoid, where the second proof is inspired by Lawvere and

Schanuel (1997).

### 1.3.2 Categorical Definition of Override

In chapter 3, entitled ‘Categorical Definition of Override’, one presents a categorical definition of partial map override, terms of topos theory. This chapter presents the School with the possibility of developing a complete topos theoretical foundation.

By giving a topos theoretical definition of partial map override, one has introduced the concept of partial map override to topos theory, thus allowing the concept of partial map override to be interpreted within different mathematical worlds or topoi. Additionally, to form a topos theoretical definition one must consider what partial map override means and what it depends upon.

The School has always espoused a constructive philosophy. The fact that partial map override is definable in an elementary topos reinforces the School’s philosophy, because an elementary topos has a natural logic, typed intuitionistic logic, which in turn is constructive logic.

A great deal of inspiration and guidance for this chapter came from reading Lawvere’s work. Specifically, a move towards topos theory was considered after reading Lawvere (1976), and a diagrammatic approach was used after reading Lawvere and Schanuel (1997). This diagrammatic approach proved very useful in clarifying one’s reasoning.

Within this chapter one:

- (i) States that the operation of overriding one partial map  $X \xrightarrow{\alpha} Y$ , from an object  $X$  to an object  $Y$ , by another partial map  $X \xrightarrow{\beta} Y$ , from the object



- (i)  $X$  to the object  $Y$ , depends upon the *shape* of the object  $X$ , that is, on how the subobjects of  $X$  are related to each other and to the whole object  $X$ .
- (ii) Defines the removal operator within an elementary topos in such a way that when one subobject is removed from another subobject the result will be another subobject. This allows one to define partial map override within an elementary topos. This answers an outstanding question within the School.
- (iii) Interprets partial maps override's behavior in three explicit worlds.
- (iv) Presents the School with the possibility of developing an intuitionistic logical foundation.

### 1.3.3 Algebraic Foundations Reconsidered

In chapter 4, entitled 'Algebraic Foundations Reconsidered', the operator calculus is extended and the algebraic foundations of the operator calculus are improved upon. The operator calculus is extended by identifying opportunities in the original calculus introduced by Mac an Airchinnigh (1990). The algebraic foundations are reconsidered and improved upon by refining Mac an Airchinnigh's original foundations, with the result that operator expressions which were not originally classified become classified. This chapter is a testament to the quality of the opportunities which existed within Mac an Airchinnigh's doctoral dissertation. Specifically one:

- (i) Identifies how partial map override and partial map composition interact. This improves upon Mac an Airchinnigh (1990, 416).



- (ii) Introduces the universal image operator to the School which is the key operator to describe the interaction of the range operator and removal operator.
- (iii) Analyses the School's concept of a map which 'iterates' over a partial map, with the result that an oversight in the original definition is corrected. Additionally, one verifies its functorial properties.
- (iv) Verifies a selection of operator relationships using the operator calculus. This demonstrates the usefulness of the operator calculus.
- (v) Identifies the boundary between the algebraic foundations and the categorical foundations of the School. One finds that the validity of algebraic relationships depend upon the categorical interpretations of the operators involved.

## Chapter 2

# Indexed Operations & Operators

Indexed operations or operators, combine or act on, partial maps, and their behavior is determined by the algebra on the codomain of the partial maps. The indexed operations and operators are applicable to system modelling. Models of systems may be built using indexed structures. Indexed operations will build indexed structures and indexed operators will reduce indexed structures.

One divides the historical development of indexed operations and operators within the Irish School into the following steps:

- (i) The development of indexed monoids began by identifying a similarity in the definition of two monoidal operations. This similarity was the seed for indexed operations in general.
- (ii) The Indexed Monoid Theorem was stated which clarified the algebra associated with an indexed operation from a monoid. This theorem may be repeatedly applied to a monoid forming an indexed tower.
- (iii) Indexed operations were found to build indexed structures. The School de-



- (iii) defined indexed operators which reduced indexed structures. These indexed operators were defined in one of two ways, which were in turn different from the way one indexes an operation from a monoid.
- (iv) The Indexed Operator Theorem was stated which clarified the algebra associated with an indexed operator.
- (v) A collection of free operators on indexed monoids were identified and their impact on an indexed tower was identified.
- (vi) The application of indexed operations and indexed operators were illustrated in the development of a model of the Irish Parliament.
- (vii) Two different types of indexed monoids were identified. One verified the monoidal properties of each type of indexed monoid. The approach taken was algebraic, where one linked each type of indexed monoid with an algebraic structure involving the  $X$ -direct power of a monoid.

One may begin this historical account by asking the following question: How may two partial maps be combined? Partial maps may be combined using one of the following techniques:

- (i) if the partial maps have disjoint domains, then one may use partial map extension,
- (ii) if the partial maps agree on the common intersection of their domains, then one may use partial map gluing,
- (iii) if the partial maps disagree on the common intersection of their domains, one may use partial map override, and



- (iv) if the partial maps disagree on the common intersection of their domains, and there is an algebra defined on their codomain, then one may use the algebra to reconcile the disagreement on the common intersection.

This final way of combining partial maps is the intuition behind indexed operations.

## 2.1 Seeds of Indexed Operations

“Properties of this operator [relational union] are inherited directly from those of set union, just as the bag [addition] operation inherited properties from addition of natural numbers. There is now enough evidence to suggest that operations, which are specified in terms of guarded [partial] map extend and [partial] map override, are themselves operators of some importance.” (Mac an Airchinnigh 1990, 228)

Mac an Airchinnigh (1990, 99; 228) noted that the algebraic properties of two operations depended on the algebraic properties of two other operations:

- (i) the operation of bag addition, denoted  $\oplus$ , depended on the operation of addition of natural numbers, denoted  $+$ , and
- (ii) the operation of relational union, denoted  $\cup$ , depended on the operation of subset union, denoted  $\cup$ .

Specifically, the operations of bag addition and relational union are associative, commutative and have an identity element, because the operations of addition of

natural numbers and subset union are associative, commutative and have an identity element. Additionally, relational union is idempotent because subset union is idempotent.

Mac an Airchinnigh (1990, 210; 228) also noted the operations of partial map extension and partial map override are used in identical ways within the definitions of bag addition and relational union.

In the following definitions, the set of non-zero natural numbers is denoted by  $\mathbb{N}'$  and the set of non-empty subsets of the set  $Y$  is denoted by  $\mathcal{P}'Y$ . Additionally, partial map override is denoted by  $\dagger$  and partial map extension is denoted by  $\sqcup$  [see appendix A for definitions of these operations].

The bag addition of a bag  $\beta \in X \rightarrow \mathbb{N}'$  to an element  $x \in X$  with a multiplicity of  $n \in \mathbb{N}'$  is defined by,

$$\beta \oplus [x \mapsto n] = \begin{cases} \beta \dagger [x \mapsto \beta(x) + n] & \text{if } x \in \text{dom } \beta, \\ \beta \sqcup [x \mapsto n] & \text{otherwise.} \end{cases} \quad (2.1)$$

Mac an Airchinnigh (1990, 120; 5:5) represented a relation  $\rho$  from a set  $X$  to a set  $Y$  using a non-empty set valued partial mapping,  $\rho \in X \rightarrow \mathcal{P}'Y$ . This definition was adopted from Eilenberg (1976, 2:2). If this view of a relation was not used, Mac an Airchinnigh would have had difficulty in seeing the relationship between the definitions of the relational union operation and the bag addition operation.

The relational union of a relation  $\rho \in X \rightarrow \mathcal{P}'Y$  with an element  $x \in X$



related to a subset  $S \in \mathcal{P}Y$  is defined by,

$$\rho \cup [x \mapsto S] = \begin{cases} \rho \uparrow [x \mapsto \rho(x) \cup S] & \text{if } x \in \text{dom } \rho, \\ \rho \sqcup [x \mapsto S] & \text{otherwise.} \end{cases} \quad (2.2)$$

Notice that the only difference in the form of the above definitions is the use of natural number addition and set union.

Both bag addition and relational union operations are only partially defined. They may be completely defined recursively, in an identical way, using the above definitions.

Both of the above operations contain two distinct cases in their definition. Hence, two different behaviors of a system may be modelled using one of the above operations.

Originally Mac an Airchinnigh (1990) used the symbol  $\oplus$  to denote both bag addition and relational union. It was not until the statement of the Indexed Monoid Theorem, by Mac an Airchinnigh (1993, 29), that the above symbol changed to  $\oplus$  for the bag addition operation and  $\cup$  for the relational union operation. This change in notation emphasised the fact that the indexed operations — relational union and bag addition — inherited their algebraic properties from the operator contained within the symbol  $\cup$ .

Mac an Airchinnigh believed correctly that the bag addition operation would form a monoid of bags  $(X \rightarrow \mathbb{N}', \oplus, \theta)$  and that the relational union operation would form a monoid of relations  $(X \rightarrow \mathcal{P}Y, \cup, \theta)$ . Using the above definitions of the operations Mac an Airchinnigh tried unsuccessfully to verify his intuition. The School was to return to this problem in 1995.

Mac an Airchinnigh noted when looking at his definition of the put command



of the file system that one could turn this definition into an operator similar to bag addition and relational union:

“Looking back at the put command of the file system, I hypothesis that with a little more thought and analysis, it can probably be turned (2.4) into an [indexed] operator, a problem I will leave for future work.”

(Mac an Airchinnigh 1990, 228)

One will now follow this insight through, as Mac an Airchinnigh was to do at a later date in his lectures to final year students.

The first version of the file system model of Bjørner and Jones (1982, 353–77) which Mac an Airchinnigh (1990, 421–41) reconsidered involves associating file names ( $F_n$ ) with page names ( $P_n$ ) which are in turn associated with pages ( $PG$ ). The file system is modelled by the subspace,

$$\varphi \in FilSys = PrtCns^{-1}\{true\} \subset F_n \rightarrow (P_n \rightarrow PG), \quad (2.3)$$

identified by the partition constraint  $PrtCns$  which ensures that:

- (i) the pages within different file names are disjoint, and
- (ii) the collection of page names associated with each file name are disjoint,

$$PrtCns: (Fn \rightarrow (Pn \rightarrow PG)) \rightarrow \mathbb{B}$$

$$PrtCns(\varphi) =$$

$$\forall fn_1, fn_2 \in \text{dom } \varphi$$

$$fn_1 \neq fn_2 \Rightarrow ((\mathcal{I} \rightarrow \text{rng}) \varphi)(fn_1) \cap ((\mathcal{I} \rightarrow \text{rng}) \varphi)(fn_2) = \emptyset \quad (2.4)$$

$\wedge$

$$\forall fn_1, fn_2 \in \text{dom } \varphi$$

$$fn_1 \neq fn_2 \Rightarrow ((\mathcal{I} \rightarrow \text{dom}) \varphi)(fn_1) \cap ((\mathcal{I} \rightarrow \text{dom}) \varphi)(fn_2) = \emptyset.$$

The put command of the file system places a page  $pg \in PG$  which has the name  $pn \in Pn$  within a particular file named  $fn \in Fn$  and is defined by,

$$Put: Fn \times Pn \times PG \rightarrow (FilSys \rightarrow FilSys)$$

$$Put_{(fn,pn,pg)}\varphi =$$

$$fn \in \text{dom } \varphi$$

$$\rightarrow pn \in \text{dom } \varphi(fn) \quad (2.5)$$

$$\rightarrow \varphi \dagger [fn \mapsto \varphi(fn) \dagger [pn \mapsto pg]]$$

$$\rightarrow \varphi \dagger [fn \mapsto \varphi(fn) \sqcup [pn \mapsto pg]]$$

$$\rightarrow \perp,$$

where Mac an Airchinnigh used the symbol  $\perp$  to mean ‘let’s not decide yet’ what to do about this situation.

The put command is subject to the pre-condition which ensures that:

- (i) the page name  $pn \in Pn$  which is to be placed within the file named  $fn \in Fn$  does not exist in any file other than possibly the file named  $fn \in Fn$ ,  
and



- (ii) the page  $pg \in PG$  which is to be placed within the file named  $fn \in Fn$  does not exist in any file other than possibly the file named  $fn \in Fn$ ,

$$PrePut: Fn \times Pn \times PG \rightarrow (FilSys \rightarrow \mathbb{B})$$

$$PrePut_{(fn, pn, pg)}\varphi = \tag{2.6}$$

$$pn \notin \cup / \text{rng}((\mathcal{I} \rightarrow \text{dom}) \triangleleft_{\{fn\}} \varphi) \wedge pg \notin \cup / \text{rng}((\mathcal{I} \rightarrow \text{rng}) \triangleleft_{\{fn\}} \varphi)$$

Hidden in the above definition of the put command is another indexed operation — indexed partial map override. The indexed partial map override ( $\oplus$ ) of a catalog  $\kappa \in X \rightarrow (Y \rightarrow Z)$  by an element  $x \in X$  which maps to a partial map  $\mu \in Y \rightarrow Z$  is defined by,

$$\kappa \oplus [x \mapsto \mu] = \begin{cases} \kappa \dagger [x \mapsto \kappa(x) \dagger \mu] & \text{if } x \in \text{dom } \kappa, \\ \kappa \sqcup [x \mapsto \mu] & \text{otherwise.} \end{cases} \tag{2.7}$$

One notes that the form of this definition is identical to the forms of the definitions of the bag addition and relational union operations.

The put command can be remodelled using the indexed partial map override operator,

$$Put: Fn \times Pn \times PG \rightarrow (FilSys \rightarrow FilSys) \tag{2.8}$$

$$Put_{(fn, pn, pg)}\varphi := \varphi \oplus [fn \mapsto [pn \mapsto pg]].$$

This command will also model a create command, which will create a new file and simultaneously add a page with a given name to this file, thus dealing with the above ‘let’s not decide yet’ situation.

By 1990 Mac an Airchinnigh had identified the importance of indexed operations. He had yet to exploit the algebraic implications of indexed operations, that is, will all indexed operations form monoids like the bag addition and relational union operations?



## 2.2 Indexed Monoid Theorem

**Theorem 2.2.1** [Indexed Monoid] *Let  $(M, *, u)$  denote an arbitrary monoid, which we shall call the base monoid, with unit  $u$ , and  $(M', *)$  the corresponding semi-group, where,  $M' = \langle_{\{u\}} M$ . Then for a non-empty set  $X$ , the structure  $(X \rightarrow M', \otimes, \theta)$  is an indexed monoid which inherits its operation properties from  $(M, *, u)$ . For an indexed structure  $\mu \in X \rightarrow M'$  and for an element  $x \in X$  which maps to an element  $m \in M'$  define*

$$\mu \otimes [x \mapsto m] = \begin{cases} \mu \sqcup [x \mapsto m] & \text{if } x \notin \text{dom } \mu, \\ \mu \uparrow [x \mapsto \mu(x) * m] & \text{otherwise.} \end{cases} \quad (2.9)$$

For convenience, let us denote by  $X \circ (M, *, u)$  the construction of the indexed monoid  $(X \rightarrow M', \otimes, \theta)$  from the base monoid  $(M, *, u)$  by indexing with respect to the set  $X$ .

The Indexed Monoid Theorem, by Mac an Airchinnigh (1993, 29), states that given a monoid — called the base monoid — and a non-empty set, a new monoid can be formed — called an indexed monoid. The operation of this indexed monoid will be the operation of the base monoid indexed. Consider the following examples:

- (i) Indexing the monoid of natural numbers under addition, by a set  $X$ , forms the monoid of bags under bag addition,

$$X \circ (\mathbb{N}, +, 0) = (X \rightarrow \mathbb{N}', \oplus, \theta).$$

- (ii) Indexing the monoid of subsets of a set  $Y$  under subset union, by a set  $X$ ,

forms the monoid of relations under relational union,

$$X \circ (\mathcal{P}Y, \cup, \emptyset) = (X \rightarrow \mathcal{P}'Y, \cup, \emptyset).$$

(iii) Indexing the monoid of partial maps from the set  $Y$  to the set  $Z$  under partial map override, by the set  $X$ , forms the monoid of catalogs under indexed partial map override,

$$X \circ (Y \rightarrow Z, \dagger, \theta) = (X \rightarrow (Y \rightarrow Z)', \oplus, \theta).$$

The concept of priming a space was introduced at this time with the statement of the theorem. The priming of a space in general denotes the removal of a unit from the space.

What inspired Mac an Airchinnigh to remove the unit  $u$  of the base monoid from the space  $M$  to form the primed space  $M'$ ? The answer to this question depends on the fact that the Indexed Monoid Theorem was created by abstracting from the monoid of bags  $(X \rightarrow \mathbb{N}', \oplus, \theta)$ .

When the School modelled a bag, it represented the fact that an item was not contained in the bag by insuring that the item was not contained in the domain of the partial map modelling the bag. It was not represented by mapping the item to zero. If the School did this an empty bag would have had to be represented by mapping every item to zero as opposed to just using the empty map.

The philosophy of the School at the time was that the mathematics should always reflect the real world. At no time should the mathematics introduce a concept which did not have an interpretation in the real world. This philosophy was to hinder the development of the School, until one proved the Indexed Monoid Theorem in 1995 by a classical algebraic approach (Donnelly, Gallagher, and Hughes



1996, 14–23).

The removal of the unit in the Indexed Monoid Theorem introduced a problem which was identified and solved in 1995.

Does the unit have to be removed as stated by the theorem to form an indexed monoid? If the unit is not removed the structure which is formed  $(X \rightarrow M, \otimes, \theta)$  will still be a monoid. This was identified in 1995.

When Mac an Airchinnigh stated this theorem he was considering indexing operations from monoids alone. Later O'Regan (1997) was to consider indexing operations from other algebraic structures.

From a pedagogical perspective, the above theorem is extremely important. If one understands the theorem and some simple monoids, then one can create more complex monoids using the theorem.

The definition of the indexed operation is incomplete. Yet it is the key element in giving a complete recursive definition,

$$\begin{aligned}
 - \otimes -: (X \rightarrow M') \times (X \rightarrow M') &\rightarrow (X \rightarrow M') \\
 \mu \otimes \theta &= \mu \\
 \mu \otimes ([x \mapsto m] \sqcup \nu) &= \\
 x \notin \text{dom } \mu & \\
 \rightarrow (\mu \sqcup [x \mapsto m]) \otimes \nu & \\
 \rightarrow (\mu \dagger [x \mapsto \mu(x) * m]) \otimes \nu. &
 \end{aligned}
 \tag{2.10}$$

Although the above definition is constructive its recursive form did not assist in the proof of basic algebraic properties, such as for example, the associativity law of a monoid. This constructive definition ties in with the constructive philosophy of the School at the time. In 1995 one was to link an indexed monoid with a

classical algebraic structure and in doing so to remove the need for a recursive definition (Donnelly, Gallagher, and Hughes 1996, 14–23). This was to broaden the philosophy of the School.

An *indexed tower* is a collection of related indexed monoids created by repeated applications of the indexed monoid theorem to a monoid:

$$\begin{array}{c}
 \vdots \\
 X_3 \circlearrowleft \uparrow \\
 (X_2 \rightarrow (X_1 \rightarrow M'), \otimes^2, \theta) \\
 X_2 \circlearrowleft \uparrow \\
 (X_1 \rightarrow M', \otimes^1, \theta) \\
 X_1 \circlearrowleft \uparrow \\
 (M, *, u)
 \end{array}$$

where  $\otimes^1$  denotes singly indexed  $*$  and  $\otimes^2$  denotes doubly indexed  $*$ .

The indexed tower formed by repeatedly indexing the monoid of subsets of a set  $Y$  under subset union:

$$\begin{array}{ccc}
 \vdots & & \vdots \\
 (\mathcal{I} \rightarrow \triangleleft.) \rho_4 \uparrow \downarrow \mathbb{U}^3 / \text{rng} & & \\
 (X_3 \rightarrow (X_2 \rightarrow (X_1 \rightarrow \mathcal{P}Y)), \mathbb{U}^3, \theta) & \rho_4 \in X_4 \rightarrow \mathcal{P}X_3 & \\
 (\mathcal{I} \rightarrow \triangleleft.) \rho_3 \uparrow \downarrow \mathbb{U}^2 / \text{rng} & & \\
 (X_2 \rightarrow (X_1 \rightarrow \mathcal{P}Y), \mathbb{U}^2, \theta) & \rho_3 \in X_3 \rightarrow \mathcal{P}X_2 & \\
 (\mathcal{I} \rightarrow \triangleleft.) \rho_2 \uparrow \downarrow \mathbb{U}^1 / \text{rng} & & \\
 (X_1 \rightarrow \mathcal{P}Y, \mathbb{U}^1, \theta) & \rho_2 \in X_2 \rightarrow \mathcal{P}X_1 & \\
 (\mathcal{I} \rightarrow \triangleleft.) \rho_1 \uparrow \downarrow \cup / \text{rng} & & \\
 (\mathcal{P}Y, \cup, \emptyset) & \rho_1 \in X_1 \rightarrow \mathcal{P}Y &
 \end{array}$$

where the units are not removed, has inspired a theory of distributed sets which is currently under development within the School.



When one builds a model of a system one identifies a space to represent the system. Examination of this space from the perspective of an indexed tower allows one to identify the ‘natural operation’ on the space which will constructively build any element in the space. In most cases this ‘natural operation’ will be found to be an indexed operation or a repeatedly indexed operation. (2.11)

By 1993 Mac an Airchinnigh had stated the Indexed Monoid Theorem and noted the existence of indexed towers. Indexed operations, from indexed monoids, build indexed structures. Are there indexed operators which will reduce indexed structures? These operators will be outer laws of an indexed monoid. In most cases these outer laws will be endomorphisms of the indexed monoid. Resulting in an indexed monoid with operators.

## 2.3 Indexed Operators

The first examples of indexed operators which reduce indexed structures appeared in (Mac an Airchinnigh 1993, 41; 43). These operators were:

- (i) relational intersection, which reduces relations,
- (ii) bag diminution or bag subtraction, which reduces bags, and
- (iii) indexed removal, which reduces relations.

The definitions given for these operators were incorrect, in so far that a particular case of the definition was omitted. One corrected them in (Hughes 1994, 2–3) and in addition one defined a number of other operators which reduce indexed structures.

The bag subtraction ( $\ominus'$ ) of an element  $x \in X$  with a multiplicity of  $n \in \mathbb{N}'$  from a bag  $\beta \in X \rightarrow \mathbb{N}'$  is defined by,

$$\ominus'_{[x \mapsto n]} \beta = \begin{cases} \beta & \text{if } x \notin \text{dom } \beta, \\ \triangleleft_{\{x\}} \beta & \text{if } x \in \text{dom } \beta \wedge \beta(x) - n \leq 0, \\ \beta \dagger [x \mapsto \beta(x) - n] & \text{otherwise.} \end{cases} \quad (2.11)$$

This definition of bag subtraction does not allow the creation of elements with zero or negative multiplicity; one can not have a bag which contains elements with a zero or negative multiplicity.

The indexed removal ( $\ominus'$ ) of an element  $x \in X$  related to a subset  $S \in \mathcal{P}Y$  from a relation  $\rho \in X \rightarrow \mathcal{P}'Y$  is defined by,

$$\ominus'_{[x \mapsto S]} \rho = \begin{cases} \rho & \text{if } x \notin \text{dom } \rho, \\ \triangleleft_{\{x\}} \rho & \text{if } x \in \text{dom } \rho \wedge \triangleleft_S \rho(x) = \emptyset, \\ \rho \dagger [x \mapsto \triangleleft_S \rho(x)] & \text{otherwise.} \end{cases} \quad (2.12)$$

The indexed removal ( $\ominus'$ ) of an element  $x \in X$  which maps to a subset  $S \in \mathcal{P}Y$  from a catalog  $\kappa \in X \rightarrow (Y \rightarrow Z)'$  is defined by,

$$\ominus'_{[x \mapsto S]} \kappa = \begin{cases} \kappa & \text{if } x \notin \text{dom } \kappa, \\ \triangleleft_{\{x\}} \kappa & \text{if } x \in \text{dom } \kappa \wedge \triangleleft_S \kappa(x) = \theta, \\ \kappa \dagger [x \mapsto \triangleleft_S \kappa(x)] & \text{otherwise.} \end{cases} \quad (2.13)$$



The indexed restriction ( $\ominus'$ ) of a relation  $\rho \in X \rightarrow \mathcal{P}'Y$  by an element  $x \in X$  related to a subset  $S \in \mathcal{P}Y$  is defined by,

$$\ominus'_{[x \mapsto S]} \rho = \begin{cases} \theta & \text{if } x \notin \text{dom } \rho, \\ \theta & \text{if } x \in \text{dom } \rho \wedge \triangleleft_S \rho(x) = \emptyset, \\ [x \mapsto \triangleleft_S \rho(x)] & \text{otherwise.} \end{cases} \quad (2.14)$$

The indexed intersection elsewhere called relational intersection ( $\odot'$ ) of a relation  $\rho \in X \rightarrow \mathcal{P}'Y$  with an element  $x \in X$  related to a subset  $S \in \mathcal{P}Y$  is defined by,

$$\rho \odot' [x \mapsto S] = \begin{cases} \theta & \text{if } x \notin \text{dom } \rho, \\ \theta & \text{if } x \in \text{dom } \rho \wedge \rho(x) \cap S = \emptyset, \\ [x \mapsto \rho(x) \cap S] & \text{otherwise.} \end{cases} \quad (2.15)$$

The indexed restriction ( $\ominus'$ ) of a catalog  $\kappa \in X \rightarrow (Y \rightarrow Z)'$  by an element  $x \in X$  which maps to a subset  $S \in \mathcal{P}Y$  is defined by,

$$\ominus'_{[x \mapsto S]} \kappa = \begin{cases} \theta & \text{if } x \notin \text{dom } \kappa, \\ \theta & \text{if } x \in \text{dom } \kappa \wedge \triangleleft_S \kappa(x) = \theta, \\ [x \mapsto \triangleleft_S \kappa(x)] & \text{otherwise.} \end{cases} \quad (2.16)$$

The definitions of the first three operators are identical in form, except for the use of the operator which is being indexed. Similarly, the definitions of the last three operators are identical in form, except for the use of the operator which is being indexed. Yet the form of these definitions are different from the definition of an indexed operation in the indexed monoid theorem. Why are the three forms different? We are indexing two different types of operators:

- (i) inner laws, and
- (ii) outer laws, where there are two ways of indexing outer laws.

(It should be noted that subset intersection can be viewed as both an inner and outer law. Here one chooses to view subset intersection as an outer law.) Inner and outer laws are taken from Papy (1964, 1; 30) [see chapter 4 for the definition of an inner law and for the definition of an outer law]. O'Regan (1997, 188; 190) was also to identify the first method of indexing an outer law.

In the case of the indexed monoid theorem we are indexing operations from monoids, inner laws. Whereas in the case of the above six definitions we are indexing outer laws, to form outer laws on indexed monoids. Hence, we now know how to index both inner and outer laws.

Bag subtraction was originally denoted by  $\ominus$  and indexed removal was originally denoted by  $R'$ . As seen above bag subtraction became  $\ominus'$  and indexed removal became  $\otimes'$ . The concept of priming an operator was introduced at this time to denote the fact that the operator would remove units from an indexed structure. This was required as the indexed space in an indexed monoid does not include units and in general an indexed operator which reduces an indexed structure will introduce units in the indexed structure. One notes that in number theory a prime on a summation sign indicates not to include some term which obviously should not be included (van der Poorten 1996, 67–8; 73). The  $\circ$  is again used to denote the fact that we are dealing with an indexed operator. Yet as was noted above the definition of the indexed operator depends on whether one is indexing an inner or outer law.

By 1994 one had identified two ways of indexing operators on monoids.



## 2.4 Indexed Operator Theorem

One was to now consider the algebra of indexed outer laws. This was inspired by following the process which Mac an Airchinnigh used to develop the indexed monoid theorem. The process had three steps:

- (i) defining how to index inner laws,
- (ii) realizing the indexed inner laws had similar algebra, and
- (iii) stating a theorem based on the similar algebra.

However, Mac an Airchinnigh failed to apply this process to the indexed outer laws he defined in 1993. One was to use this process in (Hughes 1994, 4–5) to examine indexed outer laws and found that the indexed outer laws have a similar algebra. In most cases these indexed outer laws will be endomorphisms of indexed monoids, resulting in monoids with operators. O'Regan (1997, 188) was also to arrive at this conclusion for his indexed outer laws.

The concept of a monoid with operators was introduced by Mac an Airchinnigh (1990, 123) by abstracting from groups with operators found in (Papy 1964, 152).

For each set valued partial map  $\varsigma \in X \rightarrow \mathcal{P}Y$  the operator  $\mathfrak{O}'_{\varsigma}$  is an endomorphism of the monoid of relations, that is, for any two relations  $\rho_1, \rho_2 \in X \rightarrow \mathcal{P}Y$  we find that:

$$\begin{aligned}\mathfrak{O}'_{\varsigma}(\rho_1 \cup \rho_2) &= \mathfrak{O}'_{\varsigma} \rho_1 \cup \mathfrak{O}'_{\varsigma} \rho_2, \\ \mathfrak{O}'_{\varsigma} \theta &= \theta.\end{aligned}\tag{2.17}$$

Thus, the set  $X \rightarrow \mathcal{P}Y$  is a set of operators for the monoid of relations. Hence, a monoid with operators is formed, where the monoid is the monoid of relations

and the outer law is indexed removal. This monoid with operators is denoted by  $(X \rightarrow \mathcal{P}'Y, \cup, \theta) \circledast \mathcal{O}'_{X \rightarrow \mathcal{P}Y}$ .

For each set valued partial map  $\varsigma \in X \rightarrow \mathcal{P}Y$  the operator  $\mathcal{O}'_{\varsigma}$  is an endomorphism of the monoid of catalogs, that is, for any two catalogs  $\kappa_1, \kappa_2 \in X \rightarrow (Y \rightarrow Z)'$  we find that:

$$\begin{aligned} \mathcal{O}'_{\varsigma}(\kappa_1 \oplus \kappa_2) &= \mathcal{O}'_{\varsigma} \kappa_1 \oplus \mathcal{O}'_{\varsigma} \kappa_2, \\ \mathcal{O}'_{\varsigma} \theta &= \theta. \end{aligned} \tag{2.18}$$

Thus, the set  $X \rightarrow \mathcal{P}Y$  is a set of operators for the monoid of catalogs. Hence, a monoid with operators is formed, where the monoid is the monoid of catalogs and the outer law is indexed removal. This monoid with operators is denoted by  $(X \rightarrow (Y \rightarrow Z)', \oplus, \theta) \circledast \mathcal{O}'_{X \rightarrow \mathcal{P}Y}$ .

For each set valued partial map  $\varsigma \in X \rightarrow \mathcal{P}Y$  the operator  $\mathcal{O}'_{\varsigma}$  is an endomorphism of the monoid of relations, that is, for any two relations  $\rho_1, \rho_2 \in X \rightarrow \mathcal{P}'Y$  we find that:

$$\begin{aligned} \mathcal{O}'_{\varsigma}(\rho_1 \cup \rho_2) &= \mathcal{O}'_{\varsigma} \rho_1 \cup \mathcal{O}'_{\varsigma} \rho_2, \\ \mathcal{O}'_{\varsigma} \theta &= \theta. \end{aligned} \tag{2.19}$$

Thus, the set  $X \rightarrow \mathcal{P}Y$  is a set of operators for the monoid of relations. Hence, a monoid with operators is formed, where the monoid is the monoid of relations and the outer law is indexed restriction. This monoid with operators is denoted by  $(X \rightarrow \mathcal{P}'Y, \cup, \theta) \circledast \mathcal{O}'_{X \rightarrow \mathcal{P}Y}$ .

For each relation  $\rho \in X \rightarrow \mathcal{P}'Y$  the operator  $\rho \mathcal{O}'_{-}$  is an endomorphism of the monoid of relations, that is, for any two relations  $\rho_1, \rho_2 \in X \rightarrow \mathcal{P}'Y$  we find



that:

$$\begin{aligned}\rho \ominus' (\rho_1 \cup \rho_2) &= (\rho \ominus' \rho_1) \cup (\rho \ominus' \rho_2), \\ \rho \ominus' \theta &= \theta.\end{aligned}\tag{2.20}$$

Thus, the set  $X \rightarrow \mathcal{P}'Y$  is a set of operators for the monoid of relations. Hence, a monoid with operators is formed, where the monoid is the monoid of relations and the outer law is relational intersection. This monoid with operators is denoted by  $(X \rightarrow \mathcal{P}'Y, \cup, \theta)^{\ominus'_{X \rightarrow \mathcal{P}'Y}}$ .

For each set valued partial map  $\zeta \in X \rightarrow \mathcal{P}Y$  the operator  $\ominus'_\zeta$  is an endomorphism of the monoid of catalogs, that is, for any two catalogs  $\kappa_1, \kappa_2 \in X \rightarrow (Y \rightarrow Z)'$  we find that:

$$\begin{aligned}\ominus'_\zeta(\kappa_1 \oplus \kappa_2) &= \ominus'_\zeta \kappa_1 \oplus \ominus'_\zeta \kappa_2, \\ \ominus'_\zeta \theta &= \theta.\end{aligned}\tag{2.21}$$

Thus, the set  $X \rightarrow \mathcal{P}Y$  is a set of operators for the monoid of catalogs. Hence, a monoid with operators is formed, where the monoid is the monoid of catalogs and the outer law is indexed restriction. This monoid with operators is denoted by  $(X \rightarrow (Y \rightarrow Z)', \oplus, \theta)^{\ominus'_{X \rightarrow \mathcal{P}Y}}$ .

Yet the operator  $\ominus'_\beta$  for a bag  $\beta \in X \rightarrow \mathbb{N}'$  is not an endomorphism of the monoid of bags. Thus, the monoid of bags with the outer law of bag subtraction does not form a monoid with operators. This is due to the fact that subtraction is not an endomorphism of the monoid of natural numbers under addition of natural numbers, whereas removal and restriction is an endomorphism of both the monoid of subsets of a set under subset union and the monoid of partial maps under partial map override. Also, subset intersection is an endomorphism of the monoid of subsets of a set under subset union.

One completed the above process by formulating a theorem on indexed operators. One was to consider the question: If one has a monoid with operators and one indexes the monoid, to form an indexed monoid, and one indexes the operator, to form an indexed outer law, then is the indexed monoid with the indexed outer law a monoid with operators?

**Theorem 2.4.1** [Indexed Operator] *Let  $(M, *, u)^{\circlearrowleft \Omega}$  denote an arbitrary monoid with a set of operators  $\Omega$  and let  $M' = \triangleleft_{\{u\}} M$ . Then for a non-empty set  $X$ , the structure  $(X \rightarrow M', \otimes, \theta)^{\circlearrowleft X \rightarrow \Omega}$  is an indexed monoid with a set of indexed operators  $X \rightarrow \Omega$  which inherit their operator properties from  $\Omega$ . The behaviour of an indexed operator  $\varpi \in X \rightarrow \Omega$  on an indexed structure  $\mu \in X \rightarrow M'$  is recursively defined by*

$$\begin{aligned} \dots &: (X \rightarrow \Omega) \times (X \rightarrow M') \rightarrow (X \rightarrow M') \\ \theta \mu &= \mu \\ (\varpi \sqcup [x \mapsto \omega]) \mu &= \varpi([x \mapsto \omega] \mu), \end{aligned} \tag{2.22}$$

where the base case of this recursive definition is defined by

$$[x \mapsto \omega] \mu = \begin{cases} \mu & \text{if } x \notin \text{dom } \mu, \\ \triangleleft_{\{x\}} \mu & \text{if } x \in \text{dom } \mu \wedge \omega \mu(x) = u, \\ \mu \dagger [x \mapsto \omega \mu(x)] & \text{otherwise.} \end{cases} \tag{2.23}$$

An alternative base case for the above recursive definition may be defined by

$$[x \mapsto \omega] \mu = \begin{cases} \theta & \text{if } x \notin \text{dom } \mu, \\ \theta & \text{if } x \in \text{dom } \mu \wedge \omega \mu(x) = u, \\ [x \mapsto \omega \mu(x)] & \text{otherwise.} \end{cases} \tag{2.24}$$



For either definition the indexed operator  $\varpi \in X \rightarrow \Omega$  will be an endomorphism of the indexed monoid  $(X \rightarrow M', \otimes, \theta)$ , that is, for any two indexed structures  $\mu_1, \mu_2 \in X \rightarrow M'$ ,

$$\begin{aligned} \varpi(\mu_1 \otimes \mu_2) &= \varpi\mu_1 \otimes \varpi\mu_2, \\ \varpi\theta &= \theta. \end{aligned} \tag{2.25}$$

By 1994 one had stated the Indexed Operator Theorem.

## 2.5 Free Operators & Indexed Towers

The operators on an indexed monoid arise from one of two cases:

- (i) they are operators on the base monoid which are indexed as in the above theorem, or
- (ii) they are free operators.

Every indexed monoid has a collection of free operators, independent of whether the base monoid has an operator on it which may be indexed. These free operators are removal and its dual restriction. Thus, an indexed monoid will always form a monoid with operators, where the outer laws will be removal and restriction, denoted  $(X \rightarrow M', \otimes, \theta)^{\circlearrowleft \langle \mathcal{P}X, \langle \mathcal{P}X \rangle}$ .

Why are removal and restriction operators on an indexed monoid? An indexed operator from a monoid is defined in terms of partial map extension and partial map override. The extension operator is covered by the override operator. Thus, an indexed operator from a monoid is defined in terms of override. Removal and restriction are endomorphisms of the monoid of partial maps under override. Thus, removal and restriction are endomorphisms of an indexed monoid.

We can present this argument another way, which leads to a generalization. Removal and restriction depend on the domain of an indexed structure alone. Indexed operators from monoids preserve the domains of the indexed structures they combine. Thus, removal and restriction will be endomorphisms of an indexed monoid. Generalizing this, one notes that, operators which depend on the domain of an indexed structure alone will be endomorphisms of the indexed monoid and thus will form a monoid with operators with the indexed monoid.

Let us now consider how the operators on indexed monoids arise at different levels in an indexed tower. The indexed operator theorem may be repeatedly applied to a monoid with operators, just as the indexed monoid theorem can be repeatedly applied to a monoid. Each level of indexing is entitled to the free operators of removal and restriction. Also, the free operators from the level below may be indexed.

$$\begin{array}{c}
 \vdots \\
 \uparrow \\
 X_3 \circlearrowleft \\
 (X_2 \rightarrow (X_1 \rightarrow M')', \otimes^2, \theta) \circlearrowleft^{X_2 \rightarrow (X_1 \rightarrow \Omega), \otimes^1_{X_2 \rightarrow \mathcal{P}X_1}, \triangleleft \mathcal{P}X_2} \\
 \uparrow \\
 X_2 \circlearrowleft \\
 (X_1 \rightarrow M', \otimes^1, \theta) \circlearrowleft^{X_1 \rightarrow \Omega, \triangleleft \mathcal{P}X_1} \\
 \uparrow \\
 X_1 \circlearrowleft \\
 (M, *, u) \circlearrowleft^{\Omega}
 \end{array}$$

In the diagram above we begin with a monoid with operators  $\Omega$  at the base.

At the first level of indexing, by the set  $X_1$ , the operators arise from one of two cases:



- (i) the operators  $\Omega$  on the base indexed, resulting in the operators  $X_1 \rightarrow \Omega$ , and
- (ii) the free operators of removal and restriction on this level,  $\triangleleft_{\mathcal{P}X_1}$  and  $\triangleleft'_{\mathcal{P}X_1}$ , only one of which is shown in the diagram for clarity's sake.

At the second level of indexing, by the set  $X_2$ , the operators arise from one of three cases:

- (i) the operators  $X_1 \rightarrow \Omega$  on the level below indexed, resulting in the operators  $X_2 \rightarrow (X_1 \rightarrow \Omega)$ ,
- (ii) the free operators of removal and restriction from the level below indexed, resulting in the operators  $\triangleleft'_{X_2 \rightarrow \mathcal{P}X_1}$  and  $\triangleleft_{X_2 \rightarrow \mathcal{P}X_1}$  only one of which is shown above, and
- (iii) the free operators of removal and restriction on this level,  $\triangleleft_{\mathcal{P}X_2}$  and  $\triangleleft'_{\mathcal{P}X_2}$ , again only one of which is shown in the diagram.

Hence, an indexed monoid in general has many operators on it and the higher the indexed monoid is in an indexed tower the more operators it will have.

By 1994 one had noted the free operators on an indexed monoid.

## 2.6 Dáil Model

The first comprehensive application of an indexed monoid with operators, to be published, was a model of some aspects of the relationships between political parties, elected representatives and the Irish Parliament or Dáil (Hughes and Donnelly 1995). The mathematical content of this model originated in (Hughes 1994) and Alexis Donnelly suggested that this content could be used to model the Dáil.

A Dáil is composed of a collection of political parties. Each political party has a collection of associated T.D.s (*teachta dála* means member of parliament in the Gaelic language). Furthermore, these collections of T.D.s are mutually disjoint. In addition, each T.D. has a collection of financial interests.

The Dáil model involves associating non-empty political parties ( $PP$ ) with T.D.'s ( $TD$ ) which are in turn associated with non-empty collections of financial interests ( $FI$ ). The Dáil is modeled by the subspace,

$$\delta \in Dáil = PrtCns^{-1} \{true\} \subset PP \rightarrow (TD \rightarrow \mathcal{P}'FI)', \quad (2.26)$$

identified by the partition constraint  $PrtCns$  which ensures that the collection of T.D.'s of each political party are disjoint,

$$PrtCns: (PP \rightarrow (TD \rightarrow \mathcal{P}'FI)') \rightarrow \mathbb{B}$$

$$PrtCns(\delta) = \quad (2.27)$$

$$\forall pp_1, pp_2 \in \text{dom } \delta$$

$$pp_1 \neq pp_2 \Rightarrow ((\mathcal{I} \rightarrow \text{dom}) \delta)(pp_1) \cap ((\mathcal{I} \rightarrow \text{dom}) \delta)(pp_2) = \emptyset.$$

The enter command of the Dáil should place a T.D.  $td \in TD$  with a financial interest  $fi \in FI$  within a particular political party  $pp \in PP$  and is defined by,

$$Ent: PP \times TD \times FI \rightarrow (Dáil \rightarrow Dáil) \quad (2.28)$$

$$Ent_{(pp,td,fi)} \delta = \delta \cup^2 [pp \mapsto [td \mapsto \{fi\}]].$$

The enter command is subject to a pre-condition which ensures that the T.D.  $td \in TD$  which is to be entered is not a member of any other political party within the Dáil other than possibly the political party  $pp \in PP$  into which the T.D. is to be enter,

$$PreEnt: PP \times TD \times FI \rightarrow (Dáil \rightarrow \mathbb{B}) \quad (2.29)$$

$$PreEnt_{(pp,td,fi)} \delta = td \notin \cup / \text{rng}((\mathcal{I} \rightarrow \text{dom}) \llcorner_{\{pp\}} \delta).$$



The remove command of the Dáil should remove a financial interest  $fi \in FI$  from a T.D.  $td \in TD$  who is within a particular political party  $pp \in PP$  and is defined by,

$$\begin{aligned}
 Rem: PP \times TD \times FI &\rightarrow (Dáil \rightarrow Dáil) \\
 Rem_{(pp,td,fi)}\delta &= \otimes^2_{[pp \rightarrow [td \rightarrow \{fi\}]]} \delta.
 \end{aligned}
 \tag{2.30}$$

By 1995 one had jointly developed a comprehensive model using an indexed monoid with operators — Dáil model. The publication of the Dáil model was to inspire the School to reconsider the Indexed Monoid Theorem. This was to identify two types of indexed monoids.

## 2.7 Two Types of Indexed Monoids Identified

In 1995 two types of indexed monoids were identified:

- (i) an indexed monoid with the units removed where the indexed operator is primed,  $(X \rightarrow M', \otimes', \theta)$ , and
- (ii) an indexed monoid with units where the indexed operator is not primed,  $(X \rightarrow M, \otimes, \theta)$ .

Butterfield and O'Regan initiated this discovery by attempting to index a group,  $(G, *)$  with unit  $u$ , using the indexed monoid theorem. However, they identified that the theorem, when applied to a group, will not form an indexed group. This is because the indexed group operator will not be closed. If two indexed structures are combined, using the indexed group operator, the resulting indexed structure may include units, for example,

$$[x \mapsto g] \otimes [x \mapsto g^{-1}] = [x \mapsto g * g^{-1}] = [x \mapsto u] \notin X \rightarrow G'$$

The Indexed Monoid theorem states that an indexed structure with units is not included in the indexed space of the indexed group.

Butterfield and O'Regan (1997, 184–7) solved this problem by priming the indexed operator from the indexed monoid theorem, thus forming the first of the above indexed monoids — an indexed monoid with the units removed where the indexed operator is primed,  $(X \rightarrow M', \otimes', \theta)$ . One is reminded that the priming of an operator denotes the removal of units from an indexed structure, after application of the operator. This structure was proven to be a monoid in 1995 by the School. Two approaches were used:

- (i) structural induction, and
- (ii) identifying the indexed monoid with a classical algebraic structure, that of an  $X$ -direct power of a monoid [see section 2.8 for the definition of the  $X$ -direct power of a monoid and see section 2.8.1 for a discussion on this approach].

The first method aligned with the constructive philosophy of the School, whereas, the second method, which was one's own contribution, was to broaden this philosophy as was noted above. These proofs may be found in Donnelly, Gallagher, and Hughes (1996, 2–12; 14–23) and O'Regan (1997, 184–6).

The second of the above indexed monoids — an indexed monoid with units where the indexed operator is not primed,  $(X \rightarrow M, \otimes, \theta)$  — will also resolve the above problem of indexing a group. One notes that indexed operators on this indexed monoid will not require priming. This indexed monoid may be used to represent the concept of registration in a model. One proved that this second structure was also a monoid in 1999. Again, one identifies this indexed monoid



with another classical algebraic structure, which is also based on the  $X$ -direct power of a monoid [see section 2.8.2 for a discussion on this proof].

By 1995 the School had identified two types of indexed monoids. The first of which was proven both inductively and algebraically and the second of which had yet to be proven.

## 2.8 Two Types of Indexed Monoids Verified

In 1995 one was attending an abstract algebra course in the School of Mathematics where one encountered the Durbin (1992) text on modern algebra. Included in this text was an example where Durbin introduced an algebra, that of a ring, on a space of maps, using the algebra which existed on the codomains of the maps, also that of a ring. This is nothing more than map combination by point-wise evaluation, followed by a combination of the resulting points using the algebra on the codomain.

This example was to lead one to the key realization that an indexed monoid is just another incarnation of the above concept. Specifically, the indexed monoid is related to the concept of a monoid of monoid valued maps.

This proposal at the time received considerable opposition from the School. In hindsight one realizes that this was because it challenged and extended the constructive philosophy of the School.

One proceeded to demonstrate the above intuition. This was to result in a proof of the fact that the indexed structures without units form monoids and indexed structures with units form monoids.

In both cases the approach taken was to relate the indexed monoids with

a known classical algebraic structure, which involves the  $X$ -direct power of a monoid. One introduced the concept of the  $X$ -direct power of a monoid by abstracting from the  $X$ -direct power of a group found in (Jacobson 1974, 79).

**Theorem 2.8.1** [Direct Power Monoid] *Let  $(M, *, u)$  denote an arbitrary monoid, which we shall call the base monoid, with identity  $u$ . Then for an indexing space  $X$ , we construct the space of total maps from  $X$  to  $M$ , denoted by  $M^X$ . Let  $u^X$  denote the constant map  $x \mapsto u$  for all  $x \in X$ . Then the structure  $(M^X, *, u^X)$  is a direct power monoid where for  $f, g \in M^X$  define*

$$(f * g)(x) = f(x) * g(x). \quad (2.31)$$

One achieved this relationship by totalizing the indexed structures. Totalizing is a transformation from the School's constructive philosophy to that of classical mathematics. Thus, totalizing can be used to pinpoint when the School's philosophy was challenged and changed. Totalizing is achieved by overriding on the left by a suitably selected constant map,

$$\begin{aligned} t: (X \rightarrow M') &\rightarrow M^X \\ t: \mu &\mapsto u^X \dagger \mu, \end{aligned} \quad (2.32)$$

where  $u^X$  denotes the constant map from the set  $X$  to the unit of the monoid  $(M, *, u)$ . This totalization is similar to the one found in category theory (Johnstone 1977, 28) (Goldblatt 1984, 268) (McLarty 1992, 154).

This approach results in an alternative definition for indexed operators from monoids. This definition is not recursive and is complete. Each indexed operator is defined in terms of:

- (i) an operator, involving the operator from the  $X$ -direct power of a monoid,



(ii) a mapping, and

(iii) a section of this mapping.

This approach to operator definition is also used by Bird (1987, 15).

One believes that this approach is elegant for two reasons:

- (i) The approach relates indexed monoids with classical structures, thus leading to a unification of concepts. This is in spirit of the Langlands Program, which tries to unify seemingly disjoint mathematical concepts (Singh 1997, 213–4).
- (ii) The approach introduces an additional method of proof to the School for foundational properties. Until then the School's method of proof relied upon induction over finite structures, as opposed to seeking an algebraic structure which may be used to sample or probe another structure.

The proof style that one uses is classical, that is, one uses equational reasoning (Gries and Schneider 1994).

The success of the above approach has led to a link between constructive and classical mathematics.

### 2.8.1 Indexed Structures Without Units

One developed two proofs that indexed structures, without units, form indexed monoids, without units. The second approach was inspired by that of the first. Both approaches are recorded in (Donnelly, Gallagher, and Hughes 1996, 14–23) of which the second is the most enlightening.

The first approach involved two steps:

- (i) Proving an image monoid theorem which establishes the fact that a monoid exists on the image of a mapping, provided that, a monoid exists on the domain of the mapping and the kernel relation of the mapping is a congruence relation on the monoid on the domain of the mapping. This step was prompted by Holcombe (1982, 1:2) and Finkbeiner II (1966, A:10).
- (ii) Using the image monoid theorem to verify that indexed structures without units are image monoids of  $X$ -direct power monoids under a priming map,

$$\begin{aligned} p: M^X &\rightarrow (X \rightarrow M') \\ p: f &\mapsto f', \end{aligned} \tag{2.33}$$

where the prime again denotes the removal of all entries which map to the unit of the monoid  $(M, *, u)$ .

A key realization, that came from the first approach, was that the priming map is an inverse map for the totalizing:

$$\begin{array}{ccc} & M^X & \\ & \uparrow \downarrow p & \\ t & & \\ & X \rightarrow M' & \end{array} \quad t \circ p = 1_{M^X} \quad \text{and} \quad p \circ t = 1_{X \rightarrow M'} \tag{2.34}$$

where  $1_{M^X}$  and  $1_{X \rightarrow M'}$  denote identity maps.

One used this realization to formulate a second approach, which also involved two steps:

- (i) Defining the primed indexed operation  $(\otimes')$  directly in terms of: (i) the operation from the  $X$ -direct power monoid  $(M^X, *, u^X)$ , (ii) the priming map  $p$ , and (iii) the totalizing map  $t$ . For two indexed structures without units  $\mu, \nu \in X \rightarrow M'$  define

$$\mu \otimes' \nu = p(t\mu * t\nu). \tag{2.35}$$



(ii) One verifies the monoidal properties of the now defined primed indexed operation, using the monoidal properties of the operation from the  $X$ -direct power monoid and the fact that the priming map is an inverse map for the totalizing map.

Closure: If  $\mu, \nu \in X \rightarrow M'$ , then is  $\mu \otimes' \nu \in X \rightarrow M'$ ?

Associativity: If  $\mu, \nu, \xi \in X \rightarrow M'$ , then is  $\mu \otimes' (\nu \otimes' \xi) = (\mu \otimes' \nu) \otimes' \xi$ ?

Identity: If  $\mu \in X \rightarrow M'$ , then is  $\mu \otimes' \theta = \mu = \theta \otimes' \mu$ ?

These three properties are proven below:

Closure:

$$\mu, \nu \in X \rightarrow M'$$

$$\Rightarrow \quad \{\text{application of } t\}$$

$$t\mu, t\nu \in M^X$$

$$\Rightarrow \quad \{\text{closure of } *\}$$

$$t\mu * t\nu \in M^X$$

$$\Rightarrow \quad \{\text{application of } p\}$$

$$p(t\mu * t\nu) \in X \rightarrow M'$$

$$\equiv \quad \{\text{definition of } \otimes'\}$$

$$\mu \otimes' \nu \in X \rightarrow M'$$

Associativity:

$$\begin{aligned}
& \mu \otimes' (\nu \otimes' \xi) \\
= & \quad \{\text{definition of } \otimes'\} \\
& \mu \otimes' p(t\nu * t\xi) \\
= & \quad \{\text{definition of } \otimes'\} \\
& p(t\mu * tp(t\nu * t\xi)) \\
= & \quad \{t \text{ is the inverse of } p\} \\
& p(t\mu * 1_{M^X}(t\nu * t\xi)) \\
= & \quad \{\text{apply identity map}\} \\
& p(t\mu * (t\nu * t\xi)) \\
= & \quad \{\text{associativity of } *\} \\
& p((t\mu * t\nu) * t\xi) \\
= & \quad \{\text{apply identity map}\} \\
& p(1_{M^X}(t\mu * t\nu) * t\xi) \\
= & \quad \{t \text{ is the inverse of } p\} \\
& p(tp(t\mu * t\nu) * t\xi) \\
= & \quad \{\text{definition of } \otimes'\} \\
& p(t\mu * t\nu) \otimes' \xi \\
= & \quad \{\text{definition of } \otimes'\} \\
& (\mu \otimes' \nu) \otimes' \xi
\end{aligned}$$

Identity:

$$\begin{aligned}
& \mu \otimes' \theta \\
= & \quad \{\text{definition of } \otimes'\} \\
& p(t\mu * t\theta) \\
= & \quad \{\text{evaluation of } t \text{ at } \theta\} \\
& p(t\mu * u^X) \\
= & \quad \{u^X \text{ is the identity for } *\} \\
& p(t\mu) \\
= & \quad \{p \text{ is the inverse for } t\} \\
& 1_{X \rightarrow M'} \mu = \mu = 1_{X \rightarrow M'} \mu \\
= & \quad \{p \text{ is the inverse for } t\} \\
& p(t\mu) \\
= & \quad \{u^X \text{ is the identity for } *\} \\
& p(u^X * t\mu) \\
= & \quad \{\text{evaluation of } t \text{ at } \theta\} \\
& p(t\theta * t\mu) \\
= & \quad \{\text{definition of } \otimes'\} \\
& \theta \otimes' \mu
\end{aligned}$$

Thus, the primed indexed operation is closed, associative and has an iden-



tity element. Hence, the space indexed structures, without units, under the primed indexed operation forms a monoid — an indexed monoid, without units  $(X \rightarrow M', \otimes', \theta)$ .

The indexed monoid, without units, is isomorphic to the  $X$ -direct power monoid, where the isomorphisms are the priming and totalizing maps:

$$\begin{array}{ccc}
 t(\mu \otimes' \nu) = t\mu * t\nu & \begin{array}{c} (M^X, *, u^X) \\ \uparrow t \quad \downarrow p \\ (X \rightarrow M', \otimes', \theta) \end{array} & p(f * g) = pf \otimes' pg \\
 t(\theta) = u^X & & p(u^X) = \theta
 \end{array} \tag{2.36}$$

These morphisms are verified below:

$p$  is a morphism:

$t$  is a morphism:

$$\begin{array}{ll}
 p(f * g) & t(\mu \otimes' \nu) \\
 = \quad \{\text{introduce identity maps}\} & = \quad \{\text{definition of } \otimes'\} \\
 p(1_{M^X} f * 1_{M^X} g) & t(p(t\mu * t\nu)) \\
 = \quad \{t \text{ is the inverse of } p\} & = \quad \{t \text{ is the inverse of } p\} \\
 p(tpf * tpg) & 1_{M^X}(t\mu * t\nu) \\
 = \quad \{\text{definition of } \otimes'\} & = \quad \{\text{apply identity map}\} \\
 pf \otimes' pg & t\mu * t\nu
 \end{array}$$

$$\begin{array}{ll}
 p(u^X) & t(\theta) \\
 = \quad \{\text{definition of } p\} & = \quad \{\text{definition of } t\} \\
 (u^X)' & u^X \dagger \theta \\
 = \quad \{\text{remove units}\} & = \quad \{\theta \text{ is the identity for } \dagger\} \\
 \theta & u^X
 \end{array}$$

Hence, the indexed monoid, without units, is a constructive view of the  $X$ -direct power monoid. Dually, the  $X$ -direct power monoid is a classical view of the indexed monoid, without units.

## 2.8.2 Indexed Structures with Units

One proves here that indexed structures, with units, form indexed monoids, with units. The approach is similar to the second approach above but is slightly more challenging. The analysis that was used in this approach was influenced by Lawvere and Schanuel (1997). One presented this approach to a Summer School and Workshop on Algebraic and Coalgebraic Methods in the Mathematics of Program Construction in Lincoln College, Oxford (Hughes 2000b). The approach involves seven steps:

- (i) The space of indexed structures, with units, is explored using the direct product of the  $X$ -direct power of the set  $M$  with the collection of subsets of the set  $X$ , that is,  $M^X \times \mathcal{P}X$ . This space will be referred to as the direct product space in this section.

The direct product space is used to explore the space of indexed structures, with units, by projecting the direct product space onto the space of indexed structures, with units:

$$p: M^X \times \mathcal{P}X \rightarrow (X \rightarrow M) \tag{2.37}$$

$$p: \langle f, R \rangle \mapsto \triangleleft_R f$$

A section for this projection map is chosen which involves totalizing the in-



dexed structures, with units, and recording their domains prior to totalizing:

$$\begin{aligned} s: (X \rightarrow M) &\rightarrow M^X \times \mathcal{P}X \\ s: \mu &\mapsto \langle u^X \uparrow \mu, \text{dom } \mu \rangle \end{aligned} \tag{2.38}$$

where again  $u^X$  denotes the constant map from the set  $X$  to the unit of the monoid  $(M, *, u)$ .

One must verify that the map  $s$  is a section for the projection map  $p$ , that is,

$$\begin{array}{ccc} M^X \times \mathcal{P}X & & \\ s \uparrow \downarrow p & p \circ s = 1_{X \rightarrow M} & (2.39) \\ X \rightarrow M & & \end{array}$$

One may show this using an indexed structure, with units,  $\mu \in X \rightarrow M$  by

the following argument:

$$\begin{aligned}
 & (p \circ s)\mu \\
 = & \quad \{\text{composition, application}\} \\
 & p(s\mu) \\
 = & \quad \{\text{application of } s\} \\
 & p \langle u^X \dagger \mu, \text{dom } \mu \rangle \\
 = & \quad \{\text{application of } p\} \\
 & \triangleleft_{\text{dom } \mu} (u^X \dagger \mu) \\
 = & \quad \{\triangleleft_{\text{dom } \mu} \text{ is a monoid morphism}\} \\
 & \triangleleft_{\text{dom } \mu} u^X \dagger \triangleleft_{\text{dom } \mu} \mu \\
 = & \quad \{\text{restriction of a constant map}\} \\
 & u^{\triangleleft_{\text{dom } \mu} X} \dagger \mu \\
 = & \quad \{\text{dom } \mu \subset X\} \\
 & u^{\text{dom } \mu} \dagger \mu \\
 = & \quad \{\text{override, equal domains}\} \\
 & \mu
 \end{aligned}$$

Equating the first expression with the last expression we find:

$$\begin{aligned}
 & (p \circ s)\mu = \mu \\
 \equiv & \quad \{\text{evaluation at } \mu\} \\
 & p \circ s = 1_{X \rightarrow M}
 \end{aligned}$$

Thus, the map  $s$  is a section for the projection map  $p$ .



- (ii) The projection map  $p$  and the section map  $s$  can be used to define an endomap  $e$  of the direct product space,

$$e = s \circ p. \tag{2.40}$$

This endomap will be idempotent, that is,  $e \circ e = e$ , because it was defined using a projection and a section. The endomap's effect on a point of the direct product space is,

$$e: M^X \times \mathcal{P}X \rightarrow M^X \times \mathcal{P}X \tag{2.41}$$

$$e: \langle f, R \rangle \mapsto \langle u^X \uparrow \triangleleft_R f, R \rangle.$$

Hence, the direct product space and the space of indexed structures, with units, are related by a projection and section pair,  $p$  and  $s$ . Also, the direct product space has an idempotent endomap  $e$  defined on it:

$$\begin{array}{ccc}
 M^X \times \mathcal{P}X & \xrightarrow{e} & M^X \times \mathcal{P}X \\
 \begin{array}{c} \uparrow s \\ \downarrow p \end{array} & & \\
 X & \rightarrow & M
 \end{array}$$

- (iii) As the endomap  $e$  is idempotent it will have a collection of fixed points.

A *fixed point* of the endomap  $e$  is a point of the direct product space which is unchanged after the application of  $e$ , that is,  $e \langle f, R \rangle = \langle f, R \rangle$  for the point  $\langle f, R \rangle \in M^X \times \mathcal{P}X$ . What does this property mean for a point of the

direct product space?

$$\begin{aligned}
 & e \langle f, R \rangle = \langle f, R \rangle \\
 \equiv & \quad \{\text{application of } e\} \\
 & \langle u^X \dagger \triangleleft_R f, R \rangle = \langle f, R \rangle \\
 \equiv & \quad \{\text{equality of pairs}\} \\
 & u^X \dagger \triangleleft_R f = f \\
 \equiv & \quad \{\text{override in terms of removal and extension}\} \\
 & \triangleleft_{\text{dom } \triangleleft_R f} u^X \sqcup \triangleleft_R f = f \\
 \equiv & \quad \{R \subset \text{dom } f \Rightarrow \text{dom } \triangleleft_R f = R\} \\
 & \triangleleft_R u^X \sqcup \triangleleft_R f = f \\
 \equiv & \quad \{\text{removal from a constant map}\} \\
 & u^{\triangleleft_R X} \sqcup \triangleleft_R f = f \\
 \equiv & \quad \{\text{partition of } f \text{ by the subset } R\} \\
 & u^{\triangleleft_R X} \sqcup \triangleleft_R f = \triangleleft_R f \sqcup \triangleleft_R f \\
 \equiv & \quad \{(\mu \sqcup \alpha = \nu \sqcup \alpha) \Rightarrow \mu = \nu\} \\
 & u^{\triangleleft_R X} = \triangleleft_R f
 \end{aligned}$$

Thus, the collection of fixed points of the endomap  $e$  are,

$$\text{fix-pts } e = \{ \langle f, R \rangle \in M^X \times \mathcal{P}X \mid \triangleleft_R f = u^{\triangleleft_R X} \}. \quad (2.42)$$

One may easily verify the following equalities,

$$\text{rng } s = \text{rng } e = \text{fix-pts } e. \quad (2.43)$$



(iv) If the projection map  $p$  is restricted to the collection of fixed points of the endomap  $e$  it becomes an inverse map for the section map  $s$ ,

$$\begin{array}{ccc} & \text{fix-pts } e & \\ p|_{\text{fix-pts } e} \downarrow & & \uparrow s \\ X & \rightarrow & M \end{array}$$

$$s \circ p|_{\text{fix-pts } e} = 1_{\text{fix-pts } e} \quad \text{and} \quad p|_{\text{fix-pts } e} \circ s = 1_{X \rightarrow M}. \quad (2.44)$$

Hence, we now have three spaces:

- (a) the direct product space,
- (b) the space of indexed structures, with units, and
- (c) the space of fixed points of the endomap  $e$ .

These three spaces are related as follows:

- (a) the direct product space has an endomap  $e$  defined upon it, the image of which, is the space of fixed points of the endomap  $e$  itself,
- (b) the space of fixed points is included into the direct product space,
- (c) the direct product space is projected, by  $p$ , onto the space of indexed structures, with units,
- (d) the space of indexed structures, with units, is mapped, by a section  $s$  of the projection  $p$ , onto the space of fixed points of the endomap  $e$ , and
- (e) the space of indexed structures, with units, is isomorphic to the space of fixed points of the endomap  $e$ , where the isomorphisms are given by the restricted projection map  $p|_{\text{fix-pts } e}$  and the section map  $s$ .

These relationships are summarized in the diagram below:

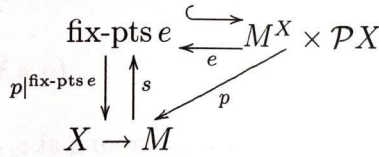

(v) The direct product space is a monoid as it is the direct product of the  $X$ -direct power of the monoid  $(M, *, u)$  with the monoid of subsets of the set  $X$  under subset union:

$$(M^X \times \mathcal{P}X, \cdot, \langle u^X, \emptyset \rangle) = (M^X, *, u^X) \times (\mathcal{P}X, \cup, \emptyset). \quad (2.45)$$

This monoid will be referred to as the direct product monoid in this section. Is the space of fixed points of the endomap  $e$  a submonoid of the direct product monoid?

Closure: If  $\langle f, R \rangle, \langle g, S \rangle \in \text{fix-pts } e$ , then is  $\langle f, R \rangle \cdot \langle g, S \rangle \in \text{fix-pts } e$ ? Or, since  $\langle f, R \rangle \cdot \langle g, S \rangle = \langle f * g, R \cup S \rangle$ , then is  $\triangleleft_{R \cup S} (f * g) = u^{\triangleleft_{R \cup S} X}$ ?

Identity: Is  $\langle u^X, \emptyset \rangle \in \text{fix-pts } e$ ? Or is  $\triangleleft_{\emptyset} u^X = u^{\triangleleft_{\emptyset} X}$ ?

These two properties are proven below:



Closure:

$$\begin{aligned}
 & \triangleleft_{R \cup S} (f * g) \\
 = & \quad \{ \triangleleft_{R \cup S} \text{ is a monoid endomorphism} \} \\
 & (\triangleleft_{R \cup S} f) * (\triangleleft_{R \cup S} g) \\
 = & \quad \{ \text{product of outer laws} \} \\
 & (\triangleleft_S \triangleleft_R f) * (\triangleleft_R \triangleleft_S g) \\
 = & \quad \{ \langle f, R \rangle, \langle g, S \rangle \in \text{fix-pts } e \} \\
 & (\triangleleft_S u^{\triangleleft_R X}) * (\triangleleft_R u^{\triangleleft_S X}) \\
 = & \quad \{ \text{removal of subsets from constant maps} \} \\
 & u^{\triangleleft_{R \cup S} X} * u^{\triangleleft_{R \cup S} X} \\
 = & \quad \{ \text{product of constant maps} \} \\
 & u^{\triangleleft_{R \cup S} X}
 \end{aligned}$$

Identity:

$$\begin{aligned}
 & \triangleleft_{\emptyset} u^X \\
 = & \quad \{ \text{removal of empty-set from constant map} \} \\
 & u^{\triangleleft_{\emptyset} X}
 \end{aligned}$$

Hence, the space of fixed points of the endomap  $e$  is a submonoid of the direct product monoid, denoted by  $(\text{fix-pts } e, \cdot, \langle u^X, \emptyset \rangle)$ .

(vi) The indexed operator ( $\otimes$ ) is defined in terms of:

(a) the operator from the submonoid of fixed points of the endomap  $(\text{fix-pts } e, \cdot, \langle u^X, \emptyset \rangle)$ ,

- (b) the projection map restricted to the collection of fixed points of the endomap  $p|_{\text{fix-pts } e}$ , and
- (c) the section map  $s$ .

For two indexed structures, with units,  $\mu, \nu \in X \rightarrow M$  define

$$\mu \otimes \nu = p|_{\text{fix-pts } e}(s\mu \cdot s\nu). \tag{2.46}$$

Figure 2.1 displays the definition of the indexed operator graphically in a style influenced by Darling (1994, 121;130).

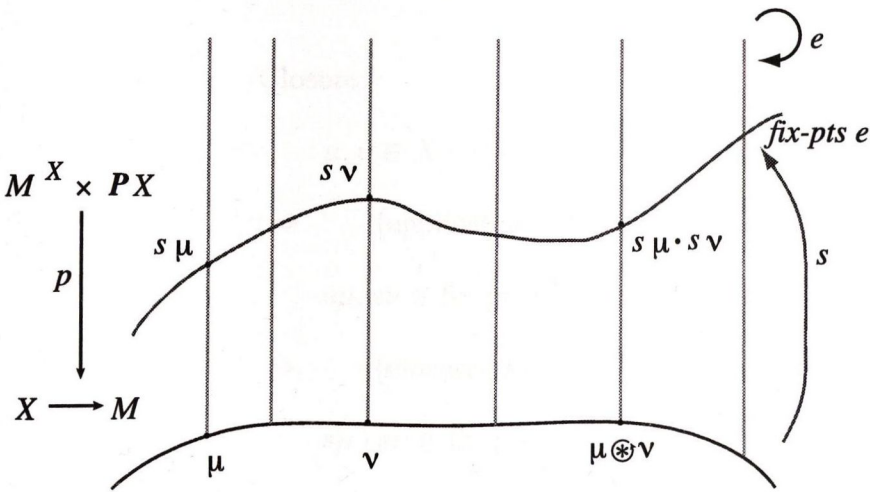

Figure 2.1: The indexed operator ( $\otimes$ ) is defined in terms of: (i) the operator from the submonoid of fixed points of the endomap  $(\text{fix-pts } e, \cdot, \langle u^X, \emptyset \rangle)$ , (ii) the projection map restricted to the collection of fixed points of the endomap  $p|_{\text{fix-pts } e}$ , and (iii) the section map  $s$ . For two indexed structures with units  $\mu, \nu \in X \rightarrow M$  define  $\mu \otimes \nu = p|_{\text{fix-pts } e}(s\mu \cdot s\nu)$ .



(vii) One verifies directly the monoidal properties of the now defined indexed operator, using the monoidal properties of the operator from the submonoid of fixed points of the endomap  $(\text{fix-pts } e, \cdot, \langle u^X, \emptyset \rangle)$  and the fact that the projection map, restricted to the collection of fixed points of the endomap, is an inverse map from the section map.

Closure: If  $\mu, \nu \in X \rightarrow M$ , then is  $\mu \otimes \nu \in X \rightarrow M$ ?

Associativity: If  $\mu, \nu, \xi \in X \rightarrow M$ , then is  $\mu \otimes (\nu \otimes \xi) = (\mu \otimes \nu) \otimes \xi$ ?

Identity: If  $\mu \in X \rightarrow M$ , then is  $\mu \otimes \theta = \mu = \theta \otimes \mu$ ?

These three properties are proven below:

Closure:

$$\mu, \nu \in X \rightarrow M$$

$$\Rightarrow \quad \{\text{application of } s\}$$

$$s\mu, s\nu \in \text{fix-pts } e$$

$$\Rightarrow \quad \{\text{closure of } \cdot\}$$

$$s\mu \cdot s\nu \in \text{fix-pts } e$$

$$\Rightarrow \quad \{\text{application of } p|_{\text{fix-pts } e}\}$$

$$p|_{\text{fix-pts } e}(s\mu \cdot s\nu) \in X \rightarrow M$$

$$\equiv \quad \{\text{definition of } \otimes\}$$

$$\mu \otimes \nu \in X \rightarrow M$$

Associativity:

$$\begin{aligned}
 & (\mu \otimes \nu) \otimes \xi \\
 = & \quad \{\text{definition of } \otimes\} \\
 & (p|_{\text{fix-pts } e}(s\mu \cdot s\nu)) \otimes \xi \\
 = & \quad \{\text{definition of } \otimes\} \\
 & p|_{\text{fix-pts } e}(sp|_{\text{fix-pts } e}(s\mu \cdot s\nu) \cdot s\xi) \\
 = & \quad \{s \text{ is the inverse of } p|_{\text{fix-pts } e}\} \\
 & p|_{\text{fix-pts } e}(1_{\text{fix-pts } e}(s\mu \cdot s\nu) \cdot s\xi) \\
 = & \quad \{\text{apply identity map}\} \\
 & p|_{\text{fix-pts } e}((s\mu \cdot s\nu) \cdot s\xi) \\
 = & \quad \{\text{associativity of } \cdot\} \\
 & p|_{\text{fix-pts } e}(s\mu \cdot (s\nu \cdot s\xi)) \\
 = & \quad \{\text{apply identity map}\} \\
 & p|_{\text{fix-pts } e}(s\mu \cdot 1_{\text{fix-pts } e}(s\nu \cdot s\xi)) \\
 = & \quad \{s \text{ is the inverse of } p|_{\text{fix-pts } e}\} \\
 & p|_{\text{fix-pts } e}(s\mu \cdot sp|_{\text{fix-pts } e}(s\nu \cdot s\xi)) \\
 = & \quad \{\text{definition of } \otimes\} \\
 & \mu \otimes p|_{\text{fix-pts } e}(s\nu \cdot s\xi) \\
 = & \quad \{\text{definition of } \otimes\} \\
 & \mu \otimes (\nu \otimes \xi)
 \end{aligned}$$

Identity:

$$\begin{aligned}
 & \mu \otimes \theta \\
 = & \quad \{\text{definition of } \otimes\} \\
 & p|_{\text{fix-pts } e}(s\mu \cdot s\theta) \\
 = & \quad \{\text{evaluation of } s \text{ at } \theta\} \\
 & p|_{\text{fix-pts } e}(s\mu \cdot \langle u^X, \emptyset \rangle) \\
 = & \quad \{\langle u^X, \emptyset \rangle \text{ is the} \\
 & \quad \text{identity for } \cdot\} \\
 & p|_{\text{fix-pts } e}(s\mu) \\
 = & \quad \{p|_{\text{fix-pts } e} \text{ is the inverse of } s\} \\
 & 1_{X \rightarrow M}\mu = \mu = 1_{X \rightarrow M}\mu \\
 = & \quad \{p|_{\text{fix-pts } e} \text{ is the inverse of } s\} \\
 & p|_{\text{fix-pts } e}(s\mu) \\
 = & \quad \{\langle u^X, \emptyset \rangle \text{ is the} \\
 & \quad \text{identity for } \cdot\} \\
 & p|_{\text{fix-pts } e}(\langle u^X, \emptyset \rangle \cdot s\mu) \\
 = & \quad \{\text{evaluation of } s \text{ at } \theta\} \\
 & p|_{\text{fix-pts } e}(s\theta \cdot s\mu) \\
 = & \quad \{\text{definition of } \otimes\} \\
 & \theta \otimes \mu
 \end{aligned}$$

Thus, the indexed operation is closed, associative and has an identity ele-



ment. Hence, the space indexed structures, with units, under the indexed operation forms a monoid — an indexed monoid, with units  $(X \rightarrow M, \otimes, \theta)$ .

The indexed monoid, with units, is isomorphic to the submonoid of fixed points of the endomap, where the isomorphisms are given by the restricted projection map and the section map:

$$\begin{array}{ccc}
 (\text{fix-pts } e, \cdot, \langle u^X, \emptyset \rangle) & & s(\mu \otimes \nu) = s\mu \cdot s\nu \\
 p|_{\text{fix-pts } e} \downarrow & \uparrow s & \\
 (X \rightarrow M, \otimes, \theta) & & s(\theta) = \langle u^X, \emptyset \rangle
 \end{array} \tag{2.47}$$

$$\begin{aligned}
 p|_{\text{fix-pts } e}(\langle f, R \rangle \cdot \langle g, R \rangle) &= p|_{\text{fix-pts } e} \langle f, R \rangle \otimes p|_{\text{fix-pts } e} \langle g, R \rangle \\
 p|_{\text{fix-pts } e}(\langle u^X, \emptyset \rangle) &= \theta
 \end{aligned} \tag{2.48}$$

These morphisms are verified below:

$p|_{\text{fix-pts } e}$  is a morphism:

$$\begin{aligned}
 & p|_{\text{fix-pts } e}(\langle f, R \rangle \cdot \langle g, R \rangle) \\
 = & \quad \{\text{apply identity map}\} \\
 & p|_{\text{fix-pts } e}(1_{\text{fix-pts } e} \langle f, R \rangle \\
 & \cdot 1_{\text{fix-pts } e} \langle g, R \rangle) \\
 = & \quad \{s \text{ is an inverse for } p|_{\text{fix-pts } e}\} \\
 & p|_{\text{fix-pts } e}(sp|_{\text{fix-pts } e} \langle f, R \rangle \\
 & \cdot sp|_{\text{fix-pts } e} \langle g, R \rangle) \\
 = & \quad \{\text{definition of } \otimes\} \\
 & p|_{\text{fix-pts } e} \langle f, R \rangle \otimes p|_{\text{fix-pts } e} \langle g, R \rangle
 \end{aligned}$$

$s$  is a morphism:

$$\begin{aligned}
 & s(\mu \otimes \nu) \\
 = & \quad \{\text{definition of } \otimes\} \\
 & sp|_{\text{fix-pts } e}(s\mu \cdot s\nu) \\
 = & \quad \{s \text{ is an inverse} \\
 & \text{for } p|_{\text{fix-pts } e}\} \\
 & 1_{\text{fix-pts } e}(s\mu \cdot s\nu) \\
 = & \quad \{\text{apply identity map}\} \\
 & s\mu \cdot s\nu
 \end{aligned}$$

$$\begin{aligned}
 & p|^{fix\text{-pts } e}(\langle u^X, \emptyset \rangle) && s(\theta) \\
 = & \{ \text{definition of } p|^{fix\text{-pts } e} \} && = \{ \text{definition of } s \} \\
 & \triangleleft_{\emptyset} u^X && \langle u^X \dagger \theta, \text{dom } \theta \rangle \\
 = & \{ \text{restriction by empty set} \} && = \{ \theta \text{ is identity for } \dagger, \\
 & \theta && \text{domain of } \theta \} \\
 & && \langle u^X, \emptyset \rangle
 \end{aligned}$$

Hence, the indexed monoid, with units, is a constructive view of the submonoid of fixed points of the endomap  $e$ . Dually, the submonoid of fixed points of the endomap  $e$  is a classical view of the indexed monoid, with units.

The projection map  $p$  becomes a morphism from the direct product space onto the indexed monoid, with units:

$$\begin{array}{ccc}
 (M^X \times \mathcal{P}X, \cdot, \langle u^X, \emptyset \rangle) & p(\langle f, R \rangle \cdot \langle g, S \rangle) = p \langle f, R \rangle \otimes p \langle g, S \rangle & (2.49) \\
 \downarrow p & & \\
 (X \rightarrow M, \otimes, \theta) & p(\langle u^X, \emptyset \rangle) = \theta &
 \end{array}$$

Before we verify this morphism consider Figure 2.2 which graphically displays the following property: the image, under the projection map  $p$ , of the product of any two points in the direct product monoid, is equal to the image, also under the projection map  $p$ , of the product of the images of the same two points of the direct product monoid, under the endomap  $e$ , that is, if  $\langle f, R \rangle, \langle g, S \rangle \in M^X \times \mathcal{P}X$ , then

$$p(\langle f, R \rangle \cdot \langle g, S \rangle) = p(e \langle f, R \rangle \cdot e \langle g, S \rangle). \tag{2.50}$$



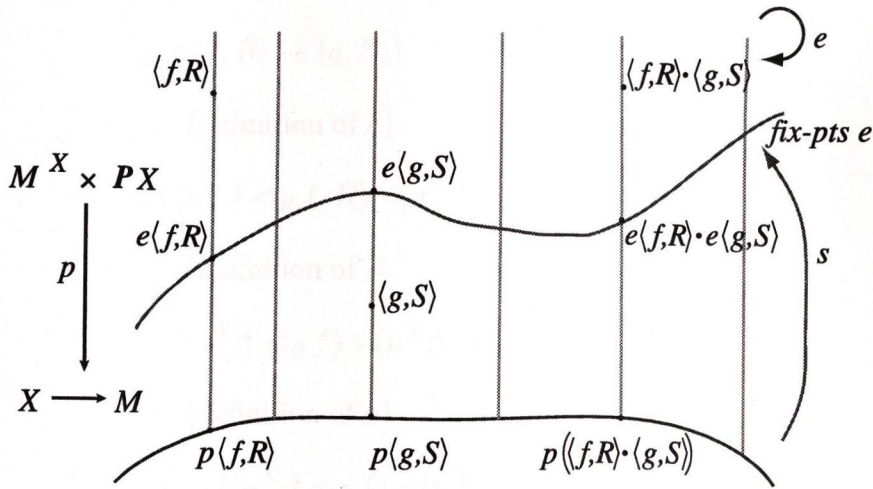

Figure 2.2: The image, under the projection map  $p$ , of the product of any two points in the direct product monoid, is equal to the image, also under the projection map  $p$ , of the product of the images of the same two points of the direct product monoid, under the endomap  $e$ , that is, if  $\langle f, R \rangle, \langle g, S \rangle \in M^X \times \mathcal{P}X$ , then  $p(\langle f, R \rangle \cdot \langle g, S \rangle) = p(e \langle f, R \rangle \cdot e \langle g, S \rangle)$ .

The image, under the endomap  $e$ , of a point of the direct product monoid is the fixed point associated with that point of the direct product monoid. Also, the image, under the projection map  $p$ , of a point of the direct product monoid is equal to the image, under the projection map  $p$ , of the fixed point associated with that point.

Hence, the above property can also be stated as: the image, under the projection map  $p$ , of the product of any two points of the direct product monoid is equal to the image, under the projection map  $p$ , of the product of their associated fixed

points. The following argument verifies this property:

$$\begin{aligned}
& p(e \langle f, R \rangle \cdot e \langle g, S \rangle) \\
= & \quad \{\text{definition of } e\} \\
& p(\langle u^X \dagger \triangleleft_R f, R \rangle \cdot \langle u^X \dagger \triangleleft_S g, S \rangle) \\
= & \quad \{\text{definition of } \cdot\} \\
& p(\langle (u^X \dagger \triangleleft_R f) * (u^X \dagger \triangleleft_S g), R \cup S \rangle) \\
= & \quad \{\text{definition of } p\} \\
& \triangleleft_{R \cup S}((u^X \dagger \triangleleft_R f) * (u^X \dagger \triangleleft_S g)) \\
= & \quad \{\triangleleft_{R \cup S} \text{ is a monoid endomorphism}\} \\
& \triangleleft_{R \cup S}(u^X \dagger \triangleleft_R f) * \triangleleft_{R \cup S}(u^X \dagger \triangleleft_S g) \\
= & \quad \{\triangleleft_{R \cup S} \text{ is a monoid endomorphism}\} \\
& (\triangleleft_{R \cup S} u^X \dagger \triangleleft_{R \cup S} \triangleleft_R f) * (\triangleleft_{R \cup S} u^X \dagger \triangleleft_{R \cup S} \triangleleft_S g) \\
= & \quad \{\text{restriction of a constant map,} \\
& \quad \text{product of outer laws}\} \\
& (u^{R \cup S} \dagger \triangleleft_{R \cup S \cup R} f) * (u^{R \cup S} \dagger \triangleleft_{R \cup S \cup S} g) \\
= & \quad \{\text{union is idempotent}\} \\
& (u^{R \cup S} \dagger \triangleleft_{R \cup S} f) * (u^{R \cup S} \dagger \triangleleft_{R \cup S} g) \\
= & \quad \{\text{override, equal domains}\} \\
& (\triangleleft_{R \cup S} f) * (\triangleleft_{R \cup S} g) \\
= & \quad \{\triangleleft_{R \cup S} \text{ is a monoid endomorphism}\} \\
& \triangleleft_{R \cup S}(f * g) \\
= & \quad \{\text{definition of } p\} \\
& p(\langle f * g, R \cup S \rangle) \\
= & \quad \{\text{definition of } \cdot\} \\
& p(\langle f, R \rangle \cdot \langle g, S \rangle)
\end{aligned}$$



Using this property we verify that the projection map  $p$  is a morphism from the direct product monoid to the indexed monoid, with units:

$p$  is a morphism:

$$\begin{aligned}
 & p(\langle f, R \rangle \cdot \langle g, S \rangle) \\
 = & \quad \{\text{images under } p \text{ of product of points and} \\
 & \quad \text{product of their associated fixed points agree}\} \\
 & p(e \langle f, R \rangle \cdot e \langle g, S \rangle) \\
 = & \quad \{p|_{\text{fix-pts } e} \text{ is a restriction of } p\} \\
 & p|_{\text{fix-pts } e}(e \langle f, R \rangle \cdot e \langle g, S \rangle) \\
 = & \quad \{p|_{\text{fix-pts } e} \text{ is a monoid morphism}\} \\
 & p|_{\text{fix-pts } e} e \langle f, R \rangle \otimes p|_{\text{fix-pts } e} e \langle g, S \rangle \\
 = & \quad \{p|_{\text{fix-pts } e} \text{ is a restriction of } p\} \\
 & pe \langle f, R \rangle \otimes pe \langle g, S \rangle \\
 = & \quad \{\text{image under } p \text{ of point and} \\
 & \quad \text{associated fixed point agree}\} \\
 & p \langle f, R \rangle \otimes p \langle g, S \rangle \\
 \\
 & p(\langle u^X, \emptyset \rangle) \\
 = & \quad \{\text{definition of } p\} \\
 & \triangleleft_{\emptyset} u^X \\
 = & \quad \{\text{restriction to empty set}\} \\
 & \theta
 \end{aligned}$$

The endomap  $e$  becomes an endomorphism of the direct produce space, the image of which is the submonoid of fixed points of the endomap  $e$ :

$$(\text{fix-pts } e, \cdot, \langle u^X, \emptyset \rangle) \begin{matrix} \hookrightarrow \\ \xleftarrow{e} \end{matrix} (M^X \times \mathcal{P}X, \cdot, \langle u^X, \emptyset \rangle)$$

$$\begin{aligned} e(\langle f, R \rangle \cdot \langle g, S \rangle) &= e \langle f, R \rangle \cdot e \langle g, S \rangle \\ e(\langle u^X, \emptyset \rangle) &= \langle u^X, \emptyset \rangle \end{aligned} \tag{2.51}$$

This is easily seen as the map  $e$  is by definition the composition of the section morphism  $s$  after the projection morphism  $p$ .

These morphisms are summarized in the diagram below:

$$\begin{array}{ccc} (\text{fix-pts } e, \cdot, \langle u^X, \emptyset \rangle) & \begin{matrix} \hookrightarrow \\ \xleftarrow{e} \end{matrix} & (M^X \times \mathcal{P}X, \cdot, \langle u^X, \emptyset \rangle) \\ p|_{\text{fix-pts } e} \downarrow & & \uparrow s \\ (X \rightarrow M, \otimes, \theta) & \xleftarrow{p} & \end{array}$$

By 1999 one had verified algebraically the monoidal properties of the two types of indexed monoids and in the process expanded the philosophy of the School.

## 2.9 Summary

This chapter has given a historical development of indexed operations and operators in the Irish School of the VDM. The key discussions and publications have been recorded and placed in context, thus capturing a significant portion of the School’s work over the past six years. This chapter has:

- (i) extended the operator calculus of the School by developing the algebra of indexed operations and operators, and



- (ii) altered the philosophy of the School by re-embracing classical mathematics.

## Chapter 3

### Categorical Definition

Models of set theory are built in the language of sets and maps. In this chapter we will see how to build models of set theory in the language of categories and functors. Can these models be used to prove theorems of set theory?

Our first goal is to answer this question by giving a categorical definition of a set. We will then see how to build a model of set theory in the language of categories and functors. This will be done by giving a categorical definition of a set. We will then see how to build a model of set theory in the language of categories and functors. This will be done by giving a categorical definition of a set. We will then see how to build a model of set theory in the language of categories and functors. This will be done by giving a categorical definition of a set.

- (i) In the language of sets, a set is a collection of objects. In the language of categories, a set is a collection of objects. In the language of categories, a set is a collection of objects. In the language of categories, a set is a collection of objects.

## Chapter 3

# Categorical Definition of Override

Models of software systems are built in the Irish School of the VDM using partial maps between sets and certain operations on these partial maps: extension, restriction, removal and override. Can these operations be given a categorical semantics?

One begins to answer this question by asking a simpler question: Can the operation of overriding a total map by a partial map be expressed in terms of composition alone? This question can be posed as either a determination problem or a choice problem. Determination and choice problems are introduced by Lawvere and Schanuel (1997, 45–9). However the determination and choice problems only have solutions in specific cases. Thus an alternative approach must be found. One may formulate an alternative approach using topos theory. There are two reasons for doing so:

- (i) In the topos of sets and maps, denoted  $\mathcal{S}$ , the operation of overriding one partial map, from a set  $X$  to a set  $Y$ , by another partial map, from the set  $X$  to the set  $Y$ , depends on the ‘shape’ on  $X$ , that is, how the subsets of  $X$  are



related to each other and to whole set  $X$ . The ‘shape’ on the set  $X$  is the *Boolean algebra*  $\mathcal{P}X$  of subsets of the set  $X$ .

This arises from the fact that the operation of override may be defined in terms of the operations of removal and extension. Specifically, when overriding one partial map by another partial map, one must remove the domain of the second partial map from the first partial map. To remove a part of  $X$  from a partial map, requires one to remove the part from the domain of the partial map. Thus, the operation of override depends upon the removal of a part of  $X$  from another part of  $X$ . Topos theory considers the relationships between the parts of an object  $X$  and the whole object  $X$  categorically.

- (ii) Lawvere (1976) believes that topos theory gives a foundation for mathematics; mathematical concepts may be given a topos theoretic semantics. As the School involves mathematical concepts, topos theory must underlie the School.

As one realises that override depends on the ‘shape’ on  $X$ , one is led to look at override in another world, where the ‘shape’ on  $X$  is different from the topos of sets and maps. Thus, one considers override within the category of topological spaces and continuous maps, denoted  $\mathcal{T}$ . Although  $\mathcal{T}$  is not a topos it is sufficiently well known to use as a backdrop for a study of override. One considers continuous partial maps from a topological space  $X$  to a topological space  $Y$ . The parts of a topological space  $X$  are *open subsets* and not just subsets. Additionally, the ‘shape’ on the topological space  $X$  is the *Heyting algebra*  $\mathcal{O}(X)$  of open subsets of  $X$ . To interpret override successfully within this category one is required to carefully interpret removal, as the topos  $\mathcal{S}$  interpretation of removal is

insufficient. Thus, one is led to three definitions of removal.

One develops the operations of extension, restriction, removal, and override in an elementary topos. Both extension and restriction can be expressed in an elementary topos. However, one finds that removal is problematic, and as one is defining override in terms of removal and extend, then override is also problematic. One must decide which of the three definitions of removal are elementary. The third definition uses an operator which is not in general elementary, whereas the first two definitions are elementary. One would hypothesize that when the third definition is valid in a particular topos it will agree with the first definition and second definition.

One demonstrates the concept of overriding one partial map by another partial map in each of the following worlds:

- (i) the topos of endomaps and endo structure preserving maps, denoted  $\mathcal{S}^{\square}$ , introduced by Lawvere and Schanuel (1997, 136–41), and
- (ii) the topos of maps and fiber structure preserving maps, denoted  $\mathcal{S}^{\downarrow}$ , introduced by Lawvere and Schanuel (1997, 144–5).

One shows that the topos  $\mathcal{S}$  interpretation of override is not sufficient for these two worlds, this is due to the fact that the topos  $\mathcal{S}$  interpretation of removal is not appropriate for these two worlds. However, one demonstrates that the three new definitions of removal are appropriate within these worlds. Finally, one shows the correct interpretation of override.

As one has successfully found an elementary definition of removal and extension, and as one is defining override in terms of removal and extension, one has found an elementary definition of override.



### 3.1 Determination and Choice Problems

Can the operation of overriding a map  $X \xrightarrow{f} Y$  by a partial map  $X \xrightarrow{\mu} Y$ , whose domain of definition is the subset

$$\text{dom } \mu = \{x\} \text{ for some } x \in X, \tag{3.1}$$

and on this subset the partial map is defined by

$$\mu(x) = y \text{ for some } y \in Y, \tag{3.2}$$

be expressed in terms of composition alone?

The resulting map  $X \xrightarrow{f \dagger \mu} Y$  should be the map  $X \xrightarrow{f} Y$  with the value  $f(x)$  in the map  $X \xrightarrow{f} Y$  replaced by the new value  $y$ . This question can be posed either as a determination problem or as a choice problem [see appendix B for a discussion of determination and choice problems].

Determination problem:

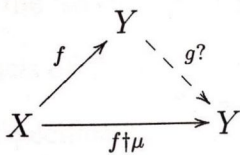

if  $|f^{-1} \{f(x)\}| = 1,$

then for  $y' \in Y$  the

map  $Y \xrightarrow{g} Y$  is defined by

Choice problem:

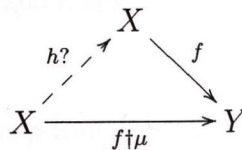

if  $f^{-1} \{y\} \neq \emptyset,$

then for  $x' \in X$  the

map  $X \xrightarrow{h} X$  is defined by

map  $Y \xrightarrow{g} Y$  is defined by

$$g(y') = \begin{cases} y & \text{if } y' = f(x), \\ y' & \text{otherwise.} \end{cases}$$

map  $X \xrightarrow{h} X$  is defined by

$$h(x') = \begin{cases} x'' & \text{if } x' = x, \\ x' & \text{otherwise,} \end{cases}$$

where  $x'' \in f^{-1}\{y\}$ .

Hence, the determination and choice problems only have solutions in specific cases. Thus, an alternative approach must be found.

### 3.2 Override depends on Shape

One considers the operation of overriding a partial map, from a set  $X$  to a set  $Y$ , by another partial map, from the set  $X$  to the set  $Y$ , in the topos of sets and maps  $\mathcal{S}$ . One finds that the operation of override depends on the 'shape' on the set  $X$ , that is, how the parts of  $X$  relate to each other and to the whole set  $X$ . One notes that the 'shape' on the set  $X$ , in topos of sets and maps, is the *Boolean algebra* of subsets of  $X$ , denoted by  $\mathcal{P}X$ .

Specifically, let  $X \xrightarrow{\alpha} Y$  be an  $\mathcal{S}$ -partial map from the set  $X = \{a, b, c\}$  to the set  $Y = \{w, x, y, z\}$ , whose domain of definition is the subset  $S = \{a, b\}$  of the set  $X$ :

$$\text{dom } \alpha = \{a, b\} \hookrightarrow X$$

and on this subset the partial map is defined by the  $\mathcal{S}$ -map  $S \xrightarrow{\alpha} Y$ :

$$\alpha = \begin{bmatrix} a \mapsto x \\ b \mapsto x \end{bmatrix}$$



Let  $X \xrightarrow{\beta} Y$  be an  $\mathcal{S}$ -partial map also from the set  $X$  to the set  $Y$ , whose domain of definition is the subset  $R = \{b, c\}$  of the set  $X$ :

$$\text{dom } \beta = \{b, c\} \hookrightarrow X$$

and on this subset the partial map is defined by the  $\mathcal{S}$ -map  $R \xrightarrow{\beta} Y$ :

$$\beta = \left[ \begin{array}{l} b \mapsto y \\ c \mapsto z \end{array} \right]$$

The operation of override may be defined in terms of the operations of removal and extension. Specifically, when overriding the partial map  $X \xrightarrow{\alpha} Y$  by the partial map  $X \xrightarrow{\beta} Y$ , one must remove the domain of the partial map  $X \xrightarrow{\beta} Y$  from the partial map  $X \xrightarrow{\alpha} Y$  and then extend the result by the partial map  $X \xrightarrow{\beta} Y$ :

$$\begin{aligned} & \alpha \dagger \beta \\ = & \quad \{\text{override in terms of removal \& extension}\} \\ & \triangleleft_{\text{dom } \beta} \alpha \sqcup \beta \end{aligned}$$

To remove the subset  $\text{dom } \beta$  of the set  $X$ , from the partial map  $X \xrightarrow{\alpha} Y$ , requires one to remove the subset  $\text{dom } \beta$  from the subset  $\text{dom } \alpha$ , thus forming a subset of the set  $\text{dom } \alpha$ , which is in turn another subset of  $X$ :

$$\begin{aligned} & \triangleleft_{\text{dom } \beta} \alpha \sqcup \beta \\ = & \quad \{\text{removal in terms of composition \& subset removal}\} \\ & (\alpha \circ (\text{dom } \alpha \hookrightarrow \triangleleft_{\text{dom } \beta} \text{dom } \alpha)) \sqcup \beta \end{aligned}$$

$$\begin{aligned}
 & (\alpha \circ (\text{dom } \alpha \hookrightarrow \triangleleft_{\text{dom } \beta} \text{dom } \alpha)) \sqcup \beta \\
 = & \quad \{\text{dom } \alpha = S \text{ and } \text{dom } \beta = R\} \\
 & (\alpha \circ (S \hookrightarrow \triangleleft_R S)) \sqcup \beta \\
 = & \quad \{\text{evaluating the composition}\} \\
 & \alpha|_{\triangleleft_R S} \sqcup \beta
 \end{aligned}$$

The notation  $\alpha|_{\triangleleft_R S}$  denotes the restriction of the map  $\alpha$ , from domain  $S$  to codomain  $Y$ , to the map from domain  $\triangleleft_R S$  to codomain  $Y$ , where  $\triangleleft_R S$  is a subset of  $S$

The operation of removal and in turn the operation of override depends on the ‘shape’ on the set  $X$ , that is, how the parts of  $X$  relate to each other and to the whole set  $X$ . The ‘shape’ on the set  $X$ , in the topos of sets and maps, is the Boolean algebra  $\mathcal{P}X$  of subsets of  $X$ :

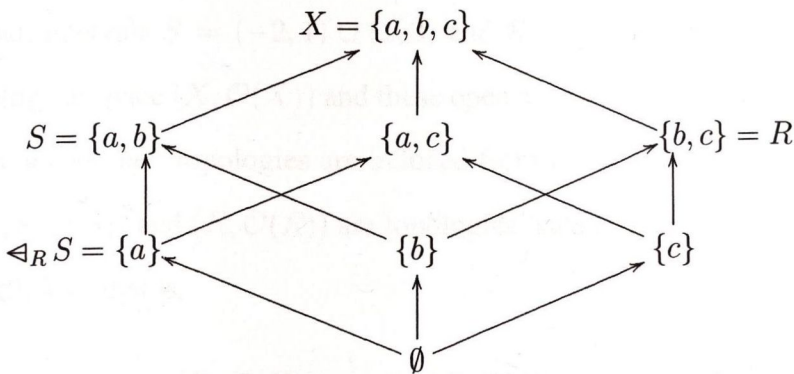

Hence, the domain of definition of the  $\mathcal{S}$ -partial map  $X \xrightarrow{\alpha \dagger \beta} Y$  is the subset  $\triangleleft_R S \cup R$  of the set  $X$ :

$$\text{dom}(\alpha \dagger \beta) = \{a, b, c\} \hookrightarrow X$$



and on this subset the partial map is defined by the  $\mathcal{S}$ -map  $(\triangleleft_R S \cup R) \xrightarrow{\alpha \dagger \beta} Y$ :

$$\alpha \dagger \beta = \begin{bmatrix} a \mapsto x \\ b \mapsto y \\ c \mapsto z \end{bmatrix}$$

### 3.3 Overriding Continuous Partial Maps

As one realises that override depends on the ‘shape’ on  $X$ , one now looks at override in another world, where the ‘shape’ on  $X$  is different from the topos of sets and maps. One considers override within the category of topological spaces and continuous maps, denoted  $\mathcal{T}$ .

Let  $X$  and  $Y$  each denote the set of real numbers. If  $\mathcal{O}(Z)$  denotes the collection of *open subsets* of a space  $Z$ , then  $(X, \mathcal{O}(X))$  and  $(Y, \mathcal{O}(Y))$  each denote the topological space of real numbers, which is an object in the category  $\mathcal{T}$ .

The open intervals  $S = (-2, 1) \cup (1, 3)$  and  $R = (-1, 4)$  are open subsets of the topological space  $(X, \mathcal{O}(X))$  and these open subsets are topological spaces themselves, where their topologies are induced from  $\mathcal{O}(X)$ . Thus, the topological spaces  $(S, \mathcal{O}(S))$  and  $(R, \mathcal{O}(R))$  are topological subspaces of the topological space  $(X, \mathcal{O}(X))$ , that is,

$$(S, \mathcal{O}(S)) \hookrightarrow (X, \mathcal{O}(X)) \quad \text{and} \quad (R, \mathcal{O}(R)) \hookrightarrow (X, \mathcal{O}(X)). \quad (3.3)$$

Let  $(X, \mathcal{O}(X)) \xrightarrow{\alpha} (Y, \mathcal{O}(Y))$  be a  $\mathcal{T}$ -partial map whose domain of definition is the topological subspace  $(S, \mathcal{O}(S))$  of the topological space  $(X, \mathcal{O}(X))$ :

$$\text{dom } \alpha = (S, \mathcal{O}(S)) \hookrightarrow (X, \mathcal{O}(X)) \quad (3.4)$$

and on this topological subspace the partial map is defined by the following  $\mathcal{T}$ -map  $(S, \mathcal{O}(S)) \xrightarrow{\alpha} (Y, \mathcal{O}(Y))$ :

$$\alpha(x) = \begin{cases} x^2 & \text{if } x \in (-2, 1), \\ 2 & \text{if } x \in (1, 3). \end{cases} \quad (3.5)$$

This map is the  $\mathcal{S}$ -map  $S \xrightarrow{\alpha} Y$  which ‘respects the topological structure’, that is, the  $\mathcal{S}$ -map is a continuous map. The graph of the  $\mathcal{S}$ -map is plotted below:

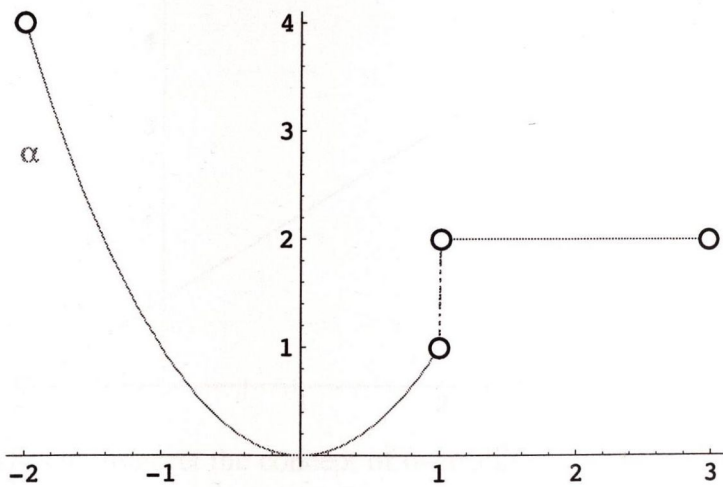

If the  $\mathcal{S}$ -map  $\alpha$  were defined at 1, then it would not be continuous at 1 as  $\lim_{x \rightarrow 1} \alpha(x)$  is not defined because

$$\lim_{x \rightarrow 1^+} \alpha(x) = 2 \quad \text{whereas} \quad \lim_{x \rightarrow 1^-} \alpha(x) = 1. \quad (3.6)$$

Hence, the  $\mathcal{S}$ -map  $\alpha$  would not respect the topological structure and thus would not be a  $\mathcal{T}$ -map. Continuity is discussed by Spivak (1967, 93).

Let  $(X, \mathcal{O}(X)) \xrightarrow{\beta} (Y, \mathcal{O}(Y))$  be a  $\mathcal{T}$ -partial map whose domain of definition is the topological subspace  $(R, \mathcal{O}(R))$  of the topological space  $(X, \mathcal{O}(X))$ :

$$\text{dom } \beta = (R, \mathcal{O}(R)) \hookrightarrow (X, \mathcal{O}(X)) \quad (3.7)$$



and on this topological subspace the partial map is defined by the following  $\mathcal{T}$ -map  $(R, \mathcal{O}(R)) \xrightarrow{\beta} (Y, \mathcal{O}(Y))$ :

$$\beta(x) = x + 1 \quad \text{if } x \in (-1, 4) \tag{3.8}$$

This map is the  $\mathcal{S}$ -map  $R \xrightarrow{\beta} Y$  which ‘respects the topological structure’, that is, the  $\mathcal{S}$ -map is a continuous map. The graph of the  $\mathcal{S}$ -map is plotted below:

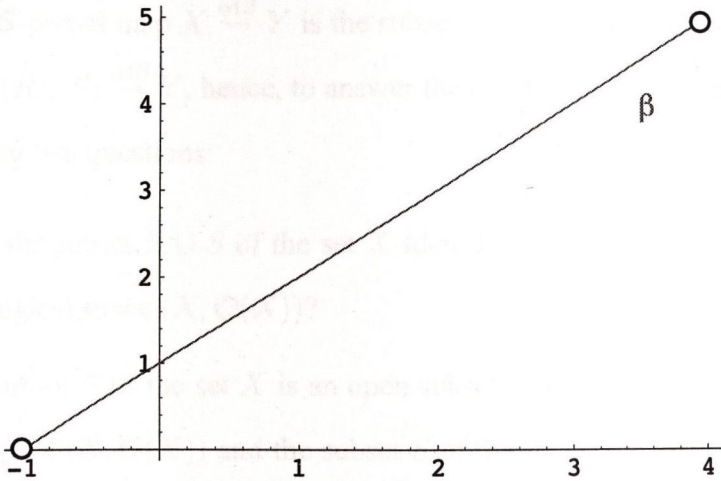

One wishes to interpret the concept of overriding one partial map by another partial map in the category of topological spaces and continuous maps.

The interpretation of the concept of overriding one partial map by another partial map in the category of topological spaces and continuous maps of topological spaces is different from its interpretation in the topos of sets and maps.

Specifically, as the  $\mathcal{T}$ -partial maps

$$(X, \mathcal{O}(X)) \xrightarrow{\alpha} (Y, \mathcal{O}(Y)) \quad \text{and} \quad (X, \mathcal{O}(X)) \xrightarrow{\beta} (Y, \mathcal{O}(Y)),$$

give rise to the  $\mathcal{S}$ -partial maps

$$X \xrightarrow{\alpha} Y \quad \text{and} \quad X \xrightarrow{\beta} Y,$$

in the obvious way, does the  $\mathcal{S}$ -partial map

$$X \overset{\alpha \dagger \beta}{\rightsquigarrow} Y$$

give rise to a  $\mathcal{T}$ -partial map

$$(X, \mathcal{O}(X)) \rightsquigarrow (Y, \mathcal{O}(Y))?$$

As the  $\mathcal{S}$ -partial map  $X \overset{\alpha \dagger \beta}{\rightsquigarrow} Y$  is the subset  $R \cup S$  of the set  $X$  together with the  $\mathcal{S}$ -map  $(R \cup S) \overset{\alpha \dagger \beta}{\rightarrow} Y$ , hence, to answer the above question one must address the following two questions:

- (i) Does the subset  $R \cup S$  of the set  $X$  identify a topological subspace of the topological space  $(X, \mathcal{O}(X))$ ?

The subset  $R$  of the set  $X$  is an open subset contained within the topological space  $(X, \mathcal{O}(X))$  and the subset  $S$  of the set  $X$  is also an open subset contained within the topological space  $(X, \mathcal{O}(X))$ .

Now the union of any two open subsets of a topological space is another open subset of the topological space. Thus, the subset  $R \cup S = (-2, 4)$  of the set  $X$  is an open subset contained within the topological space  $(X, \mathcal{O}(X))$ .

Again, the open set  $R \cup S$  is a topological space itself, where its topology is induced from  $\mathcal{O}(X)$ . Thus, the topological space  $(R \cup S, \mathcal{O}(R \cup S))$  is a topological subspace of the topological space  $(X, \mathcal{O}(X))$ .

Thus, the subset  $R \cup S$  will in fact give rise to a topological subspace  $(R \cup S, \mathcal{O}(R \cup S))$  of the topological space  $(X, \mathcal{O}(X))$ :

$$(R \cup S, \mathcal{O}(R \cup S)) \hookrightarrow (X, \mathcal{O}(X)) \quad (3.9)$$



(ii) Can the  $\mathcal{S}$ -map  $(R \cup S) \xrightarrow{\alpha \dagger \beta} Y$  be viewed as a  $\mathcal{T}$ -map from topological space  $(R \cup S, \mathcal{O}(R \cup S))$  to the topological space  $(Y, \mathcal{O}(Y))$ ?

The  $\mathcal{S}$ -map  $(R \cup S) \xrightarrow{\alpha \dagger \beta} Y$  is defined by

$$(\alpha \dagger \beta)(x) = \begin{cases} \alpha(x) & \text{if } x \in (-2, -1], \\ \beta(x) & \text{if } x \in (-1, 4). \end{cases} \quad (3.10)$$

The graph of this  $\mathcal{S}$ -map is plotted below:

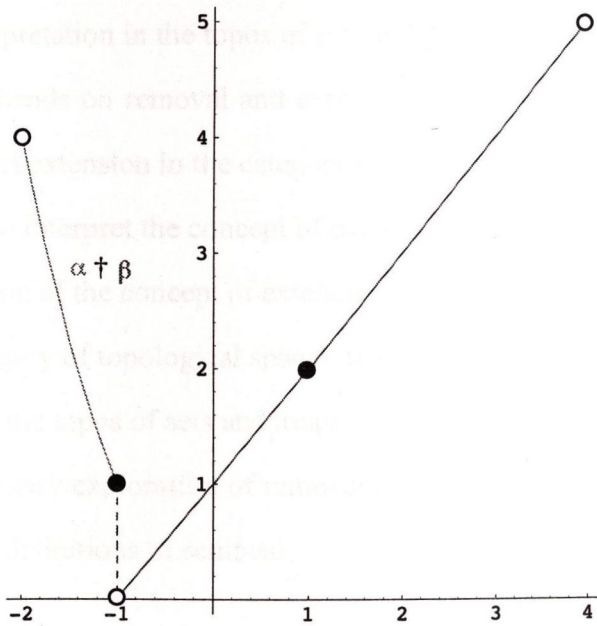

The  $\mathcal{S}$ -map  $(R \cup S) \xrightarrow{\alpha \dagger \beta} Y$  does not ‘respect the topological structure’, that is, the  $\mathcal{S}$ -map is not a continuous map.

Specifically, the  $\mathcal{S}$ -map is not continuous at  $-1$  as the  $\lim_{x \rightarrow -1} (\alpha \dagger \beta)(x)$  is not defined, because

$$\lim_{x \rightarrow -1^+} (\alpha \dagger \beta)(x) = 0 \quad \text{whereas} \quad \lim_{x \rightarrow -1^-} (\alpha \dagger \beta)(x) = 1,$$

and yet the  $\mathcal{S}$ -map is defined at  $-1$  and has the value  $\alpha(-1) = 1$ . Thus, the  $\mathcal{S}$ -map  $(R \cup S) \xrightarrow{\alpha \dagger \beta} Y$  does not give rise to a  $\mathcal{T}$ -map.

Hence, as the answer to the second question is negative the  $\mathcal{S}$ -partial map  $X \overset{\alpha\uparrow\beta}{\rightsquigarrow} Y$  can not be a  $\mathcal{T}$ -partial map  $(X, \mathcal{O}(X)) \rightsquigarrow (Y, \mathcal{O}(Y))$ . However, if the  $\mathcal{S}$ -map  $(R \cup S) \overset{\alpha\uparrow\beta}{\rightarrow} Y$  was not defined at  $-1$ , then the  $\mathcal{S}$ -map would be continuous, preserving the topological structure, and hence the  $\mathcal{S}$ -partial map  $X \overset{\alpha\uparrow\beta}{\rightsquigarrow} Y$  would be a  $\mathcal{T}$ -partial map  $(X, \mathcal{O}(X)) \rightsquigarrow (Y, \mathcal{O}(Y))$ .

Why does the interpretation of the concept of overriding one partial map by another partial map in the category of topological spaces and continuous maps differ from its interpretation in the topos of sets and maps?

As override depends on removal and extension, one must interpret the concepts of removal and extension in the category of topological spaces and continuous maps in order to interpret the concept of override.

The interpretation of the concept of extending one partial map by another partial map in the category of topological spaces and continuous maps is the same as its interpretation in the topos of sets and maps.

In one's preliminary exploration of removal in the category  $\mathcal{T}$  one arrived at the following three definitions of removal,

$$\triangleleft_{(R, \mathcal{O}(R))} (S, \mathcal{O}(S)) = (T, \mathcal{O}(T))$$

where  $T$  is defined to be one of:

- (i)  $(\neg R \text{ wrt } X) \cap S$
- (ii)  $\neg R \text{ wrt } (R \cup S)$
- (iii)  $\bigcup \{U \in \mathcal{O}(S) \mid U \cap R = \emptyset\}$

The notation  $\neg R \text{ wrt } X$  denotes the interior of the complement of open subset  $R$



with respect to the space  $X$ , that is,

$$\neg R \text{ wrt } X := (\triangleleft_R X)^\circ.$$

Additionally, the notation  $\neg R \text{ wrt } (R \cup S)$  denotes the interior of the complement of the open subset  $R$  with respect to the open subset  $R \cup S$ , that is,

$$\neg R \text{ wrt } (R \cup S) := (\triangleleft_R(R \cup S))^\circ.$$

Using any of the above definitions of removal, the result of overriding one partial map by another partial map will be a partial map which may be interpreted as a partial map within the category  $\mathcal{T}$ .

Hence, the  $\mathcal{T}$ -partial map  $(X, \mathcal{O}(X)) \xrightarrow{\alpha \dagger \beta} (Y, \mathcal{O}(Y))$  has the topological subspace  $\triangleleft_{(R, \mathcal{O}(R))}(S, \mathcal{O}(S)) \cup (R, \mathcal{O}(R))$  of the topological space  $(X, \mathcal{O}(X))$ :

$$\text{dom}(\alpha \dagger \beta) = (\triangleleft_{(R, \mathcal{O}(R))}(S, \mathcal{O}(S)) \cup (R, \mathcal{O}(R))) \hookrightarrow (X, \mathcal{O}(X)), \quad (3.11)$$

and on this topological subspace the partial map is defined by the following  $\mathcal{T}$ -map

$$(\triangleleft_{(R, \mathcal{O}(R))}(S, \mathcal{O}(S)) \cup (R, \mathcal{O}(R))) \xrightarrow{\alpha \dagger \beta} (Y, \mathcal{O}(Y)):$$

$$(\alpha \dagger \beta)(x) = \begin{cases} \alpha(x) & \text{if } x \in (-2, -1), \\ \beta(x) & \text{if } x \in (-1, 4). \end{cases} \quad (3.12)$$

This map is the  $\mathcal{S}$ -map  $((\triangleleft_R X)^\circ \cap S) \cup R \xrightarrow{\alpha \dagger \beta} Y$  which ‘respects the topological structure’, that is, the  $\mathcal{S}$ -map is a continuous map. The graph of this  $\mathcal{S}$ -map is plotted below:

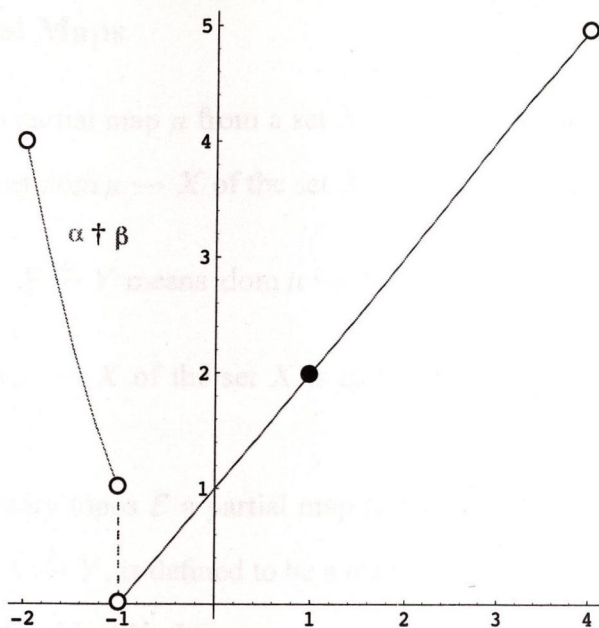

These preliminary investigations suggested that one turn to consider override in a variety of other worlds, that is, in topoi.

### 3.4 Elementary Definition of Operators

One develops the operations of extension, restriction, removal, and override in an elementary topos  $\mathcal{E}$ . These developments have been inspired by Lawvere and Schanuel (1997) and Goldblatt (1984). The definition of the operations in an elementary topos is achieved by constructing each operation in the topos  $\mathcal{S}$  of sets and maps. One must confirm that each of these constructions may be expressed in an elementary topos. This will give a categorical semantics to the operations.



### 3.4.1 Partial Maps

In the topos  $\mathcal{S}$  a partial map  $\mu$  from a set  $X$  to a set  $Y$ , denoted by  $X \overset{\mu}{\rightsquigarrow} Y$ , is a map from a subset  $\text{dom } \mu \hookrightarrow X$  of the set  $X$  to the set  $Y$ , thus,

$$X \overset{\mu}{\rightsquigarrow} Y \text{ means } \text{dom } \mu \hookrightarrow X \text{ and } \text{dom } \mu \xrightarrow{\mu} Y. \quad (3.13)$$

The subset  $\text{dom } \mu \hookrightarrow X$  of the set  $X$  is called the domain of definition of the partial map.

In an elementary topos  $\mathcal{E}$  a partial map  $\mu$  from an object  $X$  to an object  $Y$ , also denoted by  $X \overset{\mu}{\rightsquigarrow} Y$ , is defined to be a map from a subobject  $\text{dom } \mu \hookrightarrow X$  of the object  $X$  to the object  $Y$ , thus,

$$X \overset{\mu}{\rightsquigarrow} Y \text{ means } \text{dom } \mu \hookrightarrow X \text{ and } \text{dom } \mu \xrightarrow{\mu} Y. \quad (3.14)$$

The subobject  $\text{dom } \mu \hookrightarrow X$  of the object  $X$  is called the domain of definition of the partial map.

### 3.4.2 Extension

If two partial maps  $X \overset{\mu}{\rightsquigarrow} Y$  and  $X \overset{\nu}{\rightsquigarrow} Y$ , from the set  $X$  to the set  $Y$ , have disjoint domains of definition,

$$\text{dom } \mu \cap \text{dom } \nu = \emptyset, \quad (3.15)$$

then the partial map  $\mu$  may be extended by the partial map  $\nu$ , denoted  $X \overset{\mu \sqcup \nu}{\rightsquigarrow} Y$ .

The extension is the pair of maps:

- (i) The map  $\text{dom } \mu + \text{dom } \nu \xrightarrow{[\mu, \nu]} Y$ , which is the sum of the map  $\text{dom } \mu \xrightarrow{\mu} Y$  with the map  $\text{dom } \nu \xrightarrow{\nu} Y$  in the topos  $\mathcal{S}$ .

(ii) The inclusion map  $\text{dom } \mu + \text{dom } \nu \hookrightarrow X$ , which is the sum of the inclusion map  $\text{dom } \mu \hookrightarrow X$  with the inclusion map  $\text{dom } \nu \hookrightarrow X$  in the topos  $\mathcal{S}$ .

As the sum of two disjoint sets in the topos  $\mathcal{S}$  is their union,

$$\begin{aligned} & \text{dom } \mu + \text{dom } \nu \\ = & \quad \{\text{sum in topos } \mathcal{S} \text{ is disjoint union}\} \\ & \text{dom } \mu \uplus \text{dom } \nu \\ \cong & \quad \{\text{dom } \mu \cap \text{dom } \nu = \emptyset\} \\ & \text{dom } \mu \cup \text{dom } \nu \end{aligned}$$

thus, the extension of the partial map  $X \xrightarrow{\mu} Y$  by the partial map  $X \xrightarrow{\nu} Y$  is illustrated by the sum diagram

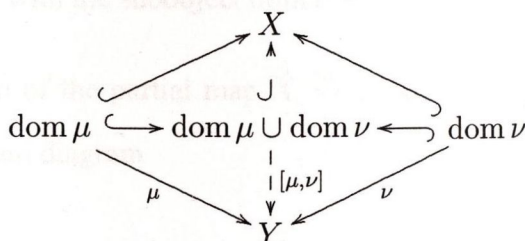

One would like to define, in an elementary topos  $\mathcal{E}$ , the extension of one partial map  $X \xrightarrow{\mu} Y$  by another partial map  $X \xrightarrow{\nu} Y$ . To achieve this one must generalize the disjointness condition to a topos. In the topos  $\mathcal{S}$  the diagram

$$\begin{array}{ccc} \emptyset & \hookrightarrow & \text{dom } \mu \\ \downarrow & & \downarrow \\ \text{dom } \nu & \hookrightarrow & X \end{array}$$

is a pullback square precisely when  $\text{dom } \mu \cap \text{dom } \nu = \emptyset$ . Thus, in an elementary topos  $\mathcal{E}$  the subobjects  $\text{dom } \mu \hookrightarrow X$  and  $\text{dom } \nu \hookrightarrow X$  are *disjoint* when the



diagram

$$\begin{array}{ccc}
 0 & \hookrightarrow & \text{dom } \mu \\
 \downarrow & & \downarrow \\
 \text{dom } \nu & \hookrightarrow & X
 \end{array}$$

is a pullback square in the topos  $\mathcal{E}$ .

Given two partial maps  $X \overset{\mu}{\rightsquigarrow} Y$  and  $X \overset{\nu}{\rightsquigarrow} Y$  in an elementary topos  $\mathcal{E}$  with this disjointness condition their extension, denoted  $X \overset{\mu \sqcup \nu}{\rightsquigarrow} Y$ , is defined to be the pair of maps:

- (i) the map  $\text{dom } \mu + \text{dom } \nu \xrightarrow{[\mu, \nu]} Y$ , which is the sum of the map  $\text{dom } \mu \xrightarrow{\mu} Y$  with the map  $\text{dom } \nu \xrightarrow{\nu} Y$  in the topos  $\mathcal{E}$ , and
- (ii) the subobject  $\text{dom } \mu + \text{dom } \nu \hookrightarrow X$ , which is the sum of the subobject  $\text{dom } \mu \hookrightarrow X$  with the subobject  $\text{dom } \nu \hookrightarrow X$  in the topos  $\mathcal{E}$ .

Thus, the extension of the partial map  $X \overset{\mu}{\rightsquigarrow} Y$  by the partial map  $X \overset{\nu}{\rightsquigarrow} Y$  is illustrated by the sum diagram

$$\begin{array}{ccccc}
 & & X & & \\
 & \swarrow & \uparrow & \nwarrow & \\
 \text{dom } \mu & \hookrightarrow & \text{dom } \mu + \text{dom } \nu & \hookleftarrow & \text{dom } \nu \\
 \searrow \mu & & \downarrow [\mu, \nu] & & \swarrow \nu \\
 & & Y & & 
 \end{array}$$

### 3.4.3 Restriction

If in the topos  $\mathcal{S}$  there is a partial map  $X \overset{\mu}{\rightsquigarrow} Y$  from a set  $X$  to a set  $Y$  and a subset  $S \hookrightarrow X$  of the set  $X$ , then one may restrict the partial map  $\mu$  by the subset  $S \hookrightarrow X$ , denoted  $X \overset{\mu|_S}{\rightsquigarrow} Y$ . This restriction is the pair of composite maps in the

diagram

$$\begin{array}{ccc}
 & \text{dom } \mu \cap S & \xrightarrow{\quad} \text{dom } \mu \xrightarrow{\mu} Y \\
 & \searrow & \downarrow \\
 & & X
 \end{array} \tag{3.16}$$

To emphasize the move from the topos  $\mathcal{S}$  to an elementary topos framework one introduces the join  $\wedge$  and meet  $\vee$  notations to replace the set-theoretic intersection  $\cap$  and union  $\cup$  operations, respectively. Details of these operations on subobjects in an elementary topos are given at the end of Appendix B.

If in an elementary topos  $\mathcal{E}$  there is a partial map  $X \overset{\mu}{\rightsquigarrow} Y$  from an object  $X$  to an object  $Y$  and there is a subobject  $S \hookrightarrow X$  of object  $X$ , then one may form the intersection of the subobject  $\text{dom } \mu \hookrightarrow X$  with the subobject  $S \hookrightarrow X$ . The composite map  $\text{dom } \mu \wedge S \hookrightarrow X$  formed by the pullback of the subobject  $\text{dom } \mu \hookrightarrow X$  along the subobject  $S \hookrightarrow X$  is the intersection of the two subobjects

$$\begin{array}{ccc}
 \text{dom } \mu \wedge S & \hookrightarrow & \text{dom } \mu \\
 \downarrow & \searrow & \downarrow \\
 S & \hookrightarrow & X
 \end{array} \tag{3.17}$$

The restriction of the partial map  $X \overset{\mu}{\rightsquigarrow} Y$  by the subobject  $S \hookrightarrow X$ , denoted  $X \overset{S \hookrightarrow X}{\rightsquigarrow} \mu Y$ , may be defined to be the pair of composite maps in the diagram

$$\begin{array}{ccc}
 & \text{dom } \mu \wedge S & \xrightarrow{\quad} \text{dom } \mu \xrightarrow{\mu} Y \\
 & \searrow & \downarrow \\
 & & X
 \end{array} \tag{3.18}$$

### 3.4.4 Removal

If in the topos  $\mathcal{S}$  there is a partial map  $X \overset{\mu}{\rightsquigarrow} Y$  from a set  $X$  to a set  $Y$  and a subset  $S \hookrightarrow X$  of the set  $X$ , then one may remove the subset  $S \hookrightarrow X$  from the



partial map  $X \overset{\mu}{\rightsquigarrow} Y$ , denoted  $X \overset{\leftarrow_S \mu}{\rightsquigarrow} Y$ . This removal is the pair of composite maps in the diagram

$$\begin{array}{ccc}
 & \curvearrowright & \\
 \leftarrow_S \text{dom } \mu & \xrightarrow{\quad \mu \quad} & \text{dom } \mu \xrightarrow{\quad \mu \quad} Y \\
 & \searrow & \downarrow \\
 & & X
 \end{array} \tag{3.19}$$

How can the subset  $\leftarrow_S \text{dom } \mu \hookrightarrow X$  be defined in the topos  $\mathcal{S}$ ? A definition of removal is needed, which will guarantee that the removal of a subset  $R \hookrightarrow X$  from another subset  $S \hookrightarrow X$  will be another subset  $\leftarrow_R S \hookrightarrow X$ .

One now moves from the topos  $\mathcal{S}$  directly to an elementary topos  $\mathcal{E}$ . There are three definitions of removal that will guarantee that the removal of a subobject  $R \hookrightarrow X$  from another subobject  $S \hookrightarrow X$  will be another subobject  $\leftarrow_R S \hookrightarrow X$ :

- (i)  $\leftarrow_{R \hookrightarrow X} S \hookrightarrow X = \neg(R \hookrightarrow X) \wedge (S \hookrightarrow X)$
- (ii)  $\leftarrow_{R \hookrightarrow X} S \hookrightarrow X = ((R \vee S) \hookrightarrow X) \circ \neg(R \hookrightarrow (R \vee S))$   
 where  $R \vee S = \text{dom}((R \hookrightarrow X) \vee (S \hookrightarrow X))$
- (iii)  $\leftarrow_{R \hookrightarrow X} S \hookrightarrow X = (S \hookrightarrow X) \circ \bigvee \left\{ A \hookrightarrow S \mid \left( (S \hookrightarrow (R \vee S)) \circ (A \hookrightarrow S) \right) \wedge (R \hookrightarrow R \vee S) = \mathbf{0} \hookrightarrow (R \vee S) \right\}$   
 where  $R \vee S = \text{dom}((R \hookrightarrow X) \vee (S \hookrightarrow X))$

Definitions 1 and 2 are elementary. The third definition, is distinguished, because, unfortunately there is still an open technical issue. Specifically, the subobject algebra of a topos is a *Heyting algebra*. It is not, in general, a *complete Heyting algebra* and one is using the union of any possible collection of subobjects, denoted above by the expression  $\bigvee \{ \dots \}$ . Although  $\bigvee$  is internally definable it is not possible in general to determine it externally to the topos itself, as discussed

by McLarty (1992, 166). However, if the elementary topos  $\mathcal{E}$  is defined over  $\mathcal{S}$ , then the subobject algebra of the topos will be a complete Heyting algebra, as discussed by Bell (1988, 141).

In an elementary topos  $\mathcal{E}$  the removal of the subobject  $S \hookrightarrow X$  of the object  $X$  from the partial map  $X \overset{\mu}{\rightsquigarrow} Y$ , denoted  $X \overset{\leftarrow S \hookrightarrow X}{\rightsquigarrow} \mu Y$ , is defined to be the pair of composite maps in the diagram

$$\begin{array}{ccc}
 \leftarrow_S \text{dom } \mu & \xrightarrow{\mu} & \text{dom } \mu \xrightarrow{\mu} Y \\
 & \searrow & \downarrow \\
 & & X
 \end{array} \tag{3.20}$$

### 3.4.5 Override

Given two partial maps  $X \overset{\mu}{\rightsquigarrow} Y$  and  $X \overset{\nu}{\rightsquigarrow} Y$  from a set  $X$  to a set  $Y$  in the topos  $\mathcal{S}$ , the partial map  $\mu$  can be overridden by the partial map  $\nu$ , denoted  $X \overset{\mu \uparrow \nu}{\rightsquigarrow} Y$ . This is the partial map formed by the expression

$$\leftarrow_{\text{dom } \nu} \mu \sqcup \nu. \tag{3.21}$$

Additionally, this expression is always defined in an elementary topos  $\mathcal{E}$  because one can always remove the subobject  $\text{dom } \nu \hookrightarrow X$  from the partial map  $X \overset{\mu}{\rightsquigarrow} Y$  to form the partial map  $X \overset{\leftarrow{\text{dom } \nu}}{\rightsquigarrow} \mu Y$  and then extend by the partial map  $X \overset{\nu}{\rightsquigarrow} Y$ .

## 3.5 Topos of Endomaps of Sets

Let  $X^{\circ f}$  be the following object in the topos  $\mathcal{S}^{\circ}$  of endomaps of sets:



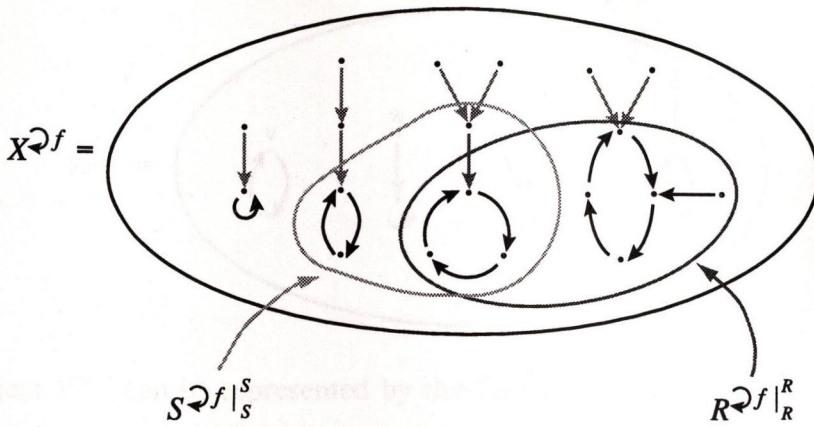

The notation  $f|_S^S$  denotes the restriction of the endomap  $f$ , from domain  $X$  to codomain  $X$ , to the endomap from domain  $S$  to codomain  $S$ , where  $S$  is a subset of  $X$ .

Where  $S^{\circlearrowleft f|_S^S}$  and  $R^{\circlearrowleft f|_R^R}$  are also objects in the topos  $\mathcal{S}^{\circlearrowleft}$  of endomaps of sets, these objects are subobjects of the object  $X^{\circlearrowleft f}$ , that is,

$$S^{\circlearrowleft f|_S^S} \hookrightarrow X^{\circlearrowleft f} \quad \text{and} \quad R^{\circlearrowleft f|_R^R} \hookrightarrow X^{\circlearrowleft f}. \quad (3.22)$$

These objects are subobjects of the object  $X^{\circlearrowleft f}$  because if an element  $x$  of the set  $X$  ‘enters’ the subset  $R$  or the subset  $S$  under repeated application of  $f$ , then the element never ‘leaves’ either subset under further applications of  $f$ , that is,

$$\forall x \in X: \exists m \in \mathbb{N}: f^m x \in R \Rightarrow \forall n \in \mathbb{N}: f^{m+n} x \in R, \quad (3.23)$$

and

$$\forall x \in X: \exists m \in \mathbb{N}: f^m x \in S \Rightarrow \forall n \in \mathbb{N}: f^{m+n} x \in S. \quad (3.24)$$

Let  $Y^{\circlearrowleft g}$  be the following object in the topos  $\mathcal{S}^{\circlearrowleft}$  of endomaps of sets:

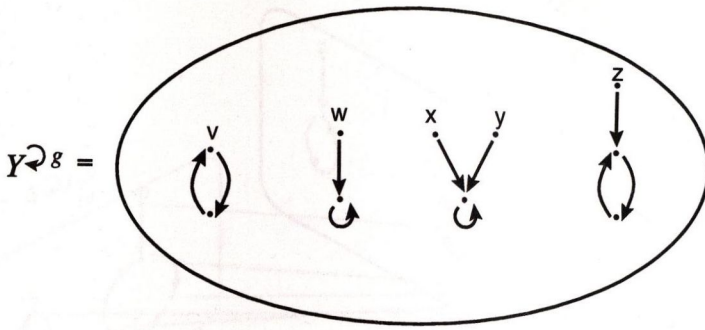

The object  $Y \curvearrowright g$  can be represented by the following *generators*, and *relations* among the generators:

<i>generator</i> of $Y \curvearrowright g$	<i>relation</i> in $Y \curvearrowright g$
$v$	$g^2v = v$
$w$	$g^2w = gw$
$x$	$g^2x = gx$
$y$	$gy = gx$
$z$	$g^3z = gz$

Let  $X \curvearrowright f \xrightarrow{\alpha} Y \curvearrowright g$  be an  $\mathcal{S} \curvearrowright$ -partial map whose domain of definition is the subobject  $S \curvearrowright f|_S^S \hookrightarrow X \curvearrowright f$  of the object  $X \curvearrowright f$ :

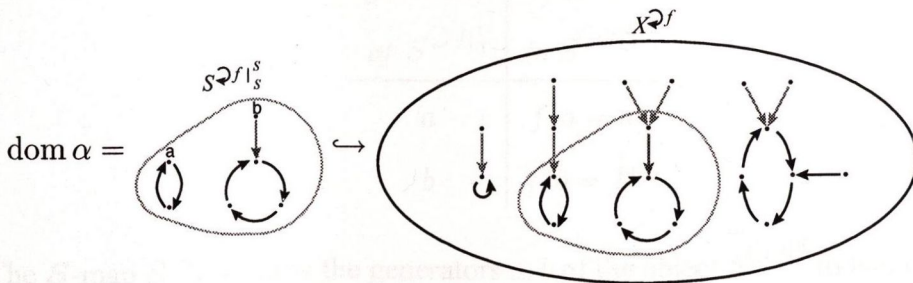

and on this subobject the partial map is defined by the following  $\mathcal{S} \curvearrowright$ -map  $S \curvearrowright f|_S^S \xrightarrow{\alpha} Y \curvearrowright g$ :



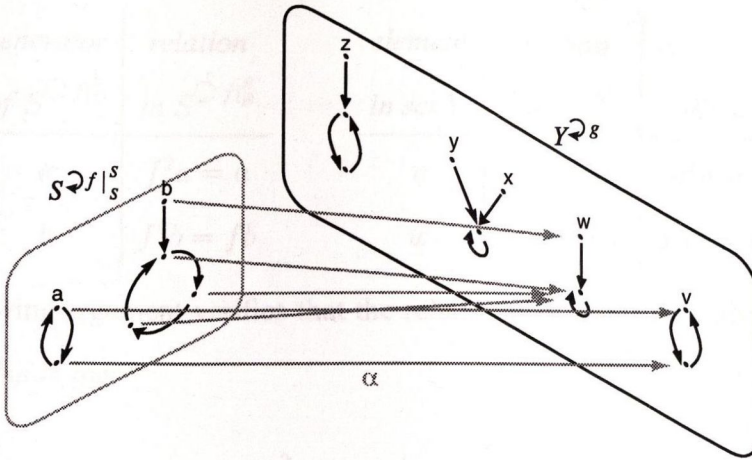

This map is an  $\mathcal{S}$ -map  $S \xrightarrow{\alpha} Y$  which ‘respects the endomap structure’, that is,

$$\alpha \circ f|_S^S = g \circ \alpha. \tag{3.25}$$

Why does the  $\mathcal{S}$ -map  $S \xrightarrow{\alpha} Y$  preserve the endomap structure? The  $\mathcal{S}$ -map  $S \xrightarrow{\alpha} Y$  preserves the endomap structure because it maps the generators of the object  $S^{\circlearrowleft} f|_S^S$  to elements of the set  $Y$  with relations which are the ‘same’ as the relations of the generators of the object  $S^{\circlearrowleft} f|_S^S$ .

Specifically, the object  $S^{\circlearrowleft} f|_S^S$  is represented by the following generators and relations among the generators:

generator of $S^{\circlearrowleft} f _S^S$	relation in $S^{\circlearrowleft} f _S^S$
$a$	$f^2 a = a$
$b$	$f^4 b = f b$

The  $\mathcal{S}$ -map  $S \xrightarrow{\alpha} Y$  maps the generators  $a, b$  of the object  $S^{\circlearrowleft} f|_S^S$  to two elements  $v, w$  of the set  $Y$ , that is,  $\alpha(a) = v$  and  $\alpha(b) = w$ . The elements  $v, w$  have relations  $g^2 v = v$  and  $g^2 w = g w$  which are equivalent to the relations among the generators  $a, b$  of the object  $S^{\circlearrowleft} f|_S^S$ :

<i>generator</i> of $S \curvearrowright f _S^S$	<i>relation</i> in $S \curvearrowright f _S^S$	<i>element</i> in set $Y$	<i>relation</i> in $Y \curvearrowright g$	<i>equivalent</i> <i>relation</i>
$a$	$f^2a = a$	$v$	$g^2v = v$	$g^2v = v$
$b$	$f^4b = fb$	$w$	$g^2w = gw$	$g^4w = gw$

The following argument verifies that the relation  $g^2w = gw$  is equivalent to the relation  $g^4w = gw$ :

$$\begin{aligned}
 &g^2w = gw \\
 \equiv & \quad \{\text{separate power}\} \\
 &ggw = gw \\
 \equiv & \quad \{\text{relation } g^2w = gw\} \\
 &gg^2w = gw \\
 \equiv & \quad \{\text{exchange powers}\} \\
 &g^2gw = gw \\
 \equiv & \quad \{\text{relation } g^2w = gw\} \\
 &g^2g^2w = gw \\
 \equiv & \quad \{\text{combine powers}\} \\
 &g^4w = gw
 \end{aligned}$$



Let  $X \curvearrowright^f \xrightarrow{\beta} Y \curvearrowright^g$  be an  $\mathcal{S}^\curvearrowright$ -partial map whose domain of definition is the subobject  $R \curvearrowright^f |_R^R \hookrightarrow X \curvearrowright^f$  of the object  $X \curvearrowright^f$ :

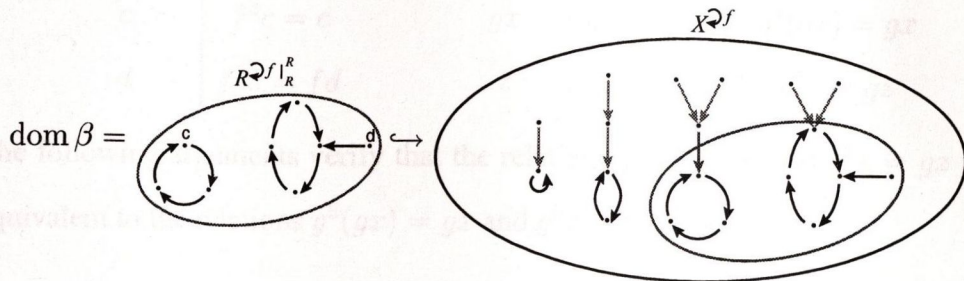

and on this subobject the partial map is defined by the following  $\mathcal{S}^\curvearrowright$ -map  $R \curvearrowright^f |_R^R \xrightarrow{\beta} Y \curvearrowright^g$ :

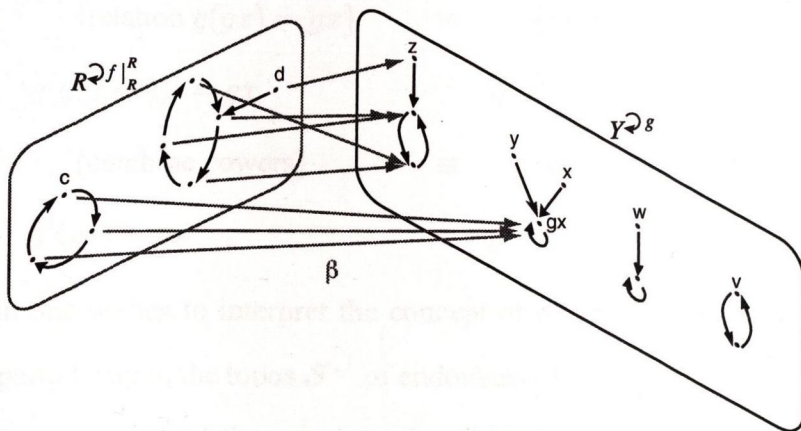

This map is the  $\mathcal{S}$ -map  $R \xrightarrow{\beta} Y$  which ‘respects the endomap structure’, that is,

$$\beta \circ f|_R^R = g \circ \beta. \tag{3.26}$$

Once again, the  $\mathcal{S}$ -map  $R \xrightarrow{\beta} Y$  preserves the endomap structure because it maps the generators  $c, d$  of the object  $R \curvearrowright^f |_R^R$  to elements  $gx, z$  of the set  $Y$  with relations which are equivalent to the relations among the generators  $c, d$  of the object  $R \curvearrowright^f |_R^R$ .

<i>generator</i> of $R^{\circlearrowleft} f _R^R$	<i>relation</i> in $R^{\circlearrowleft} f _R^R$	<i>element</i> in set $Y$	<i>relation</i> in $Y^{\circlearrowleft} g$	<i>equivalent</i> <i>relation</i>
$c$	$f^3c = c$	$gx$	$g(gx) = gx$	$g^3(gx) = gx$
$d$	$f^5d = fd$	$z$	$g^3z = gz$	$g^5z = gz$

The following arguments verify that the relations  $g(gx) = gx$  and  $g^3z = gz$  are equivalent to the relations  $g^3(gx) = gx$  and  $g^5z = gz$  respectively:

$$\begin{array}{ll}
 g(gx) = gx & g^3z = gz \\
 \equiv \{ \text{relation } g(gx) = gx \} & \equiv \{ \text{separate power} \} \\
 g(g(gx)) = gx & g^2gz = gz \\
 \equiv \{ \text{relation } g(gx) = gx \} & \equiv \{ \text{relation } g^3z = gz \} \\
 g(g(g(gx))) = gx & g^2g^3z = gz \\
 \equiv \{ \text{combine powers} \} & \equiv \{ \text{combine powers} \} \\
 g^3(gx) = gx & g^5z = gz
 \end{array}$$

Again one wishes to interpret the concept of overriding one partial map by another partial map in the topos  $\mathcal{S}^{\circlearrowleft}$  of endomaps of sets.

The interpretation of the concept of overriding one partial map by another partial map in the topos  $\mathcal{S}^{\circlearrowleft}$  of endomaps of sets is different from its interpretation in the topos  $\mathcal{S}$ . Specifically, as the  $\mathcal{S}^{\circlearrowleft}$ -partial maps  $X^{\circlearrowleft} f \xrightarrow{\alpha} Y^{\circlearrowleft} g$  and  $X^{\circlearrowleft} f \xrightarrow{\beta} Y^{\circlearrowleft} g$  give rise to the  $\mathcal{S}$ -partial maps  $X \xrightarrow{\alpha} Y$  and  $X \xrightarrow{\beta} Y$ , in the obvious way, is the  $\mathcal{S}$ -partial map  $X \xrightarrow{\alpha \dagger \beta} Y$  an  $\mathcal{S}^{\circlearrowleft}$ -partial map  $X^{\circlearrowleft} f \rightsquigarrow Y^{\circlearrowleft} g$ ? As the  $\mathcal{S}$ -partial map  $X \xrightarrow{\alpha \dagger \beta} Y$  is the subset  $R \cup S$  of the set  $X$  together with the  $\mathcal{S}$ -map  $R \cup S \xrightarrow{\alpha \dagger \beta} Y$ , hence, to answer the above question one must address the following two questions:



(i) Does the subset  $R \cup S$  of the set  $X$  identify a subobject of the object  $X \curvearrowright f$ ?

The subset  $R \cup S$  gives rise to the subobject  $(S \cup R) \curvearrowright f|_{(S \cup R)} \hookrightarrow X \curvearrowright f$  of the object  $X \curvearrowright f$ :

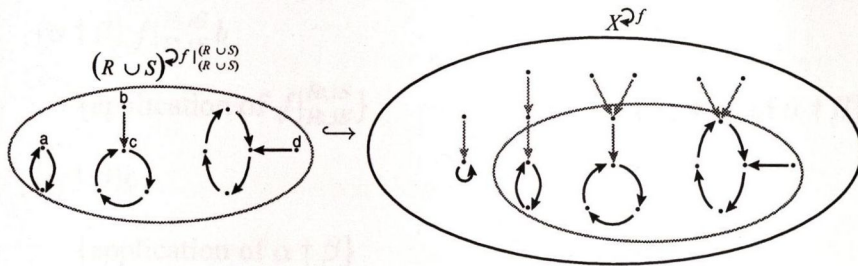

This is because if an element  $x$  of the set  $X$  ‘enters’ the subset  $R \cup S$  under repeated application of  $f$ , then the element never ‘leaves’ the subset  $R \cup S$  under further applications of  $f$ .

(ii) Is the  $\mathcal{S}$ -map  $R \cup S \xrightarrow{\alpha \dagger \beta} Y$  an  $\mathcal{S} \curvearrowright$ -map  $(S \cup R) \curvearrowright f|_{(S \cup R)} \rightarrow Y \curvearrowright g$ ?

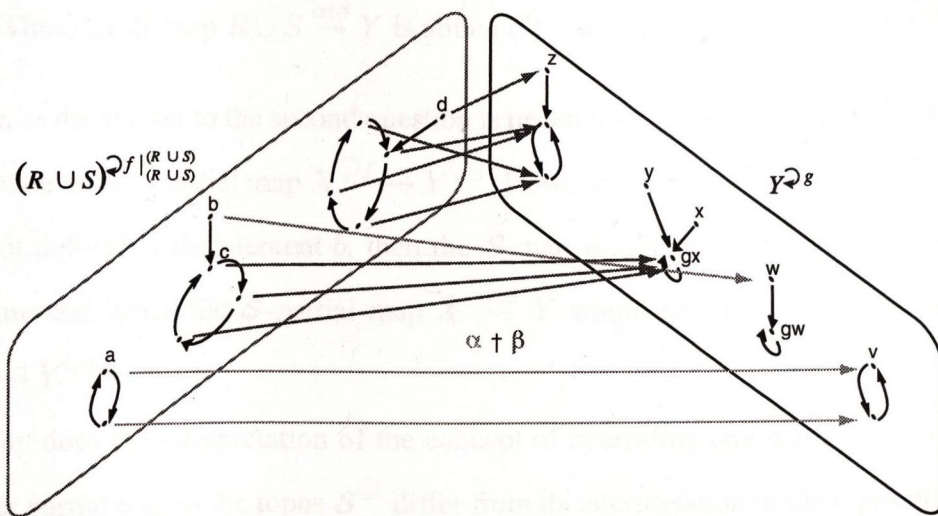

The following argument demonstrates that the endomap structure is not preserved by the  $\mathcal{S}$ -map  $R \cup S \xrightarrow{\alpha \dagger \beta} Y$  by evaluating each composite map  $(\alpha \dagger \beta) \circ f|_{R \cup S}^{R \cup S}$  and  $g \circ (\alpha \dagger \beta)$  at the element  $b$  of the set  $R \cup S$  and

find that their results disagree:

$$\begin{array}{ll}
 ((\alpha \dagger \beta) \circ f|_{RUS}^{RUS})b & (g \circ (\alpha \dagger \beta))b \\
 = \{ \text{composition, application} \} & = \{ \text{composition, application} \} \\
 (\alpha \dagger \beta) f|_{RUS}^{RUS} b & g(\alpha \dagger \beta)b \\
 = \{ \text{application of } f|_{RUS}^{RUS} \} & = \{ \text{application of } \alpha \dagger \beta \} \\
 (\alpha \dagger \beta)c & gw \\
 = \{ \text{application of } \alpha \dagger \beta \} & \neq \{ \text{diagram} \} \\
 gx & gx
 \end{array}$$

The  $\mathcal{S}$ -map  $R \cup S \xrightarrow{\alpha \dagger \beta} Y$  does not respect the endomap structure, that is,

$$(\alpha \dagger \beta) \circ f|_{RUS}^{RUS} \neq g \circ (\alpha \dagger \beta). \quad (3.27)$$

Thus, the  $\mathcal{S}$ -map  $R \cup S \xrightarrow{\alpha \dagger \beta} Y$  is not an  $\mathcal{S}^\circ$ -map  $(S \cup R)^\circ f|_{(S \cup R)}^{(S \cup R)} \rightarrow Y^\circ g$ .

Hence, as the answer to the second question is negative the  $\mathcal{S}$ -partial map  $X \xrightarrow{\alpha \dagger \beta} Y$  can not be an  $\mathcal{S}^\circ$ -partial map  $X^\circ f \rightsquigarrow Y^\circ g$ . However, if the  $\mathcal{S}$ -map  $R \cup S \xrightarrow{\alpha \dagger \beta} Y$  was not defined at the element  $b$ , then the  $\mathcal{S}$ -map would preserve the endomap structure and hence the  $\mathcal{S}$ -partial map  $X \xrightarrow{\alpha \dagger \beta} Y$  would be an  $\mathcal{S}^\circ$ -partial map  $X^\circ f \rightsquigarrow Y^\circ g$ .

Why does the interpretation of the concept of overriding one partial map by another partial map in the topos  $\mathcal{S}^\circ$  differ from its interpretation in the topos  $\mathcal{S}$ ?

As override depends on removal and extension, one must interpret the concepts of removal and extension in the topos  $\mathcal{S}^\circ$  of endomaps of sets in order to interpret the concept of override.



The interpretation of the concept of extending one partial map by another partial map in the topos  $\mathcal{S}^\circlearrowleft$  is the same as its interpretation in the topos  $\mathcal{S}$ .

The concept of removing a subobject from a partial map depends upon the concept of removing one subobject from another subobject. Thus one must interpret the concept of removing one subobject from another subobject in the topos  $\mathcal{S}^\circlearrowleft$ .

The interpretation of the concept of removing one subobject from another subobject in the topos  $\mathcal{S}^\circlearrowleft$  is different from its interpretation in the topos  $\mathcal{S}$ . Specifically, as the subobjects  $R^\circlearrowleft f|_R^R \hookrightarrow X^\circlearrowleft f$  and  $S^\circlearrowleft f|_S^S \hookrightarrow X^\circlearrowleft f$  of the object  $X^\circlearrowleft f$  give rise to the subsets  $R$  and  $S$  of the set  $X$ , in the obvious way, does the subset  $\triangleleft_R S$  of the set  $X$  identify a subobject of the object  $X^\circlearrowleft f$ ?

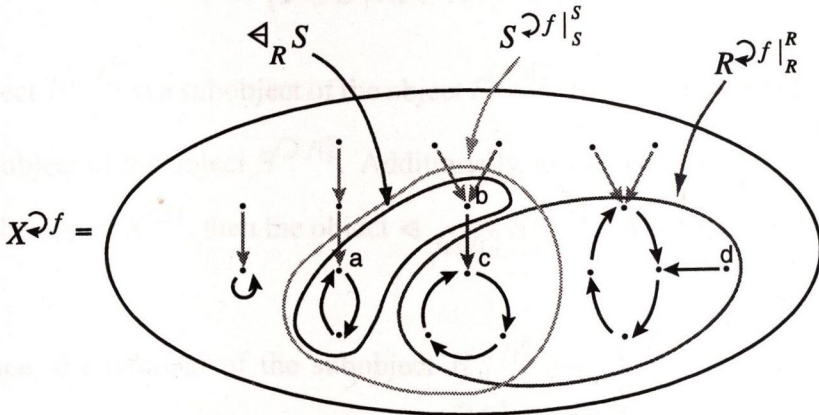

The subset  $\triangleleft_R S$  of the set  $X$  does not identify a subobject of the object  $X^\circlearrowleft f$ . This is because the element  $b$  of the subset  $\triangleleft_R S$  ‘leaves’ the subset after an application of  $f$ , that is,  $b \in \triangleleft_R S$  yet  $fb \notin \triangleleft_R S$ .

What subobject of the object  $X^\circlearrowleft f$  should the *removal* of the subobject  $R^\circlearrowleft f|_R^R \hookrightarrow X^\circlearrowleft f$  from the subobject  $S^\circlearrowleft f|_S^S \hookrightarrow X^\circlearrowleft f$  identify?

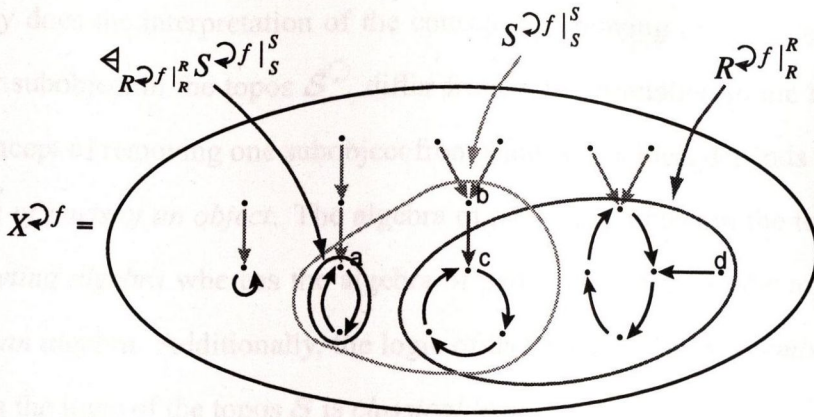

The object  $\triangleleft_{R^{\circlearrowleft} f|_R^R S^{\circlearrowleft} f|_S^S}$  is defined to be the object  $T^{\circlearrowleft} f|_T^T$  where  $T$  is the subset of the set  $S$  which contains only those elements  $x$  of the set  $S$  which never ‘enter’ the set  $R$  under repeated applications of  $f$ , that is,

$$T = \{x \in S \mid \forall n \in \mathbb{N}: f^n x \notin R\}. \tag{3.28}$$

The object  $T^{\circlearrowleft} f|_T^T$  is a subobject of the object  $S^{\circlearrowleft} f|_S^S$ . Hence the object  $\triangleleft_{R^{\circlearrowleft} f|_R^R S^{\circlearrowleft} f|_S^S}$  is a subobject of the object  $S^{\circlearrowleft} f|_S^S$ . Additionally, as the object  $S^{\circlearrowleft} f|_S^S$  is a subobject of the object  $X^{\circlearrowleft} f$ , then the object  $\triangleleft_{R^{\circlearrowleft} f|_R^R S^{\circlearrowleft} f|_S^S}$  is a subobject of the object  $X^{\circlearrowleft} f$ .

Hence, the removal of the subobject  $R^{\circlearrowleft} f|_R^R \hookrightarrow X^{\circlearrowleft} f$  from the subobject  $S^{\circlearrowleft} f|_S^S \hookrightarrow X^{\circlearrowleft} f$  is the subobject  $\triangleleft_{R^{\circlearrowleft} f|_R^R S^{\circlearrowleft} f|_S^S} \hookrightarrow X^{\circlearrowleft} f$ , that is,

$$\triangleleft_{(R^{\circlearrowleft} f|_R^R \hookrightarrow X^{\circlearrowleft} f)} (S^{\circlearrowleft} f|_S^S \hookrightarrow X^{\circlearrowleft} f) = \triangleleft_{R^{\circlearrowleft} f|_R^R} S^{\circlearrowleft} f|_S^S \hookrightarrow X^{\circlearrowleft} f. \tag{3.29}$$

The interpretation of the concept of removing one subobject from another subobject in the topos  $\mathcal{S}^{\circlearrowleft}$  is different from the topos  $\mathcal{S}$  interpretation. Thus, the interpretation of the concept of overriding one partial map by another partial map in the topos  $\mathcal{S}^{\circlearrowleft}$  is different from its interpretation in the topos  $\mathcal{S}$ .



Why does the interpretation of the concept of removing one subobject from another subobject in the topos  $\mathcal{S}^\circlearrowleft$  differ from its interpretation in the topos  $\mathcal{S}$ ? The concept of removing one subobject from another subobject depends upon the *algebra of parts of an object*. The algebra of parts of an object in the topos  $\mathcal{S}^\circlearrowleft$  is a *Heyting algebra* whereas the algebra of parts of an object in the topos  $\mathcal{S}$  is a *Boolean algebra*. Additionally, the logic of the topos  $\mathcal{S}^\circlearrowleft$  is *intuitionistic logic* whereas the logic of the topos  $\mathcal{S}$  is *classical logic*.

Specifically, the removal of the subobject  $R^\circlearrowleft fl_R^R \hookrightarrow X^\circlearrowleft f$  from the subobject  $S^\circlearrowleft fl_S^S \hookrightarrow X^\circlearrowleft f$  is defined using the algebra of parts by any one of the following three expressions:

- (i) The intersection of the negation of the subobject  $R^\circlearrowleft fl_R^R \hookrightarrow X^\circlearrowleft f$  with respect to the object  $X^\circlearrowleft f$  with the subobject  $S^\circlearrowleft fl_S^S \hookrightarrow X^\circlearrowleft f$ , that is,

$$\neg(R^\circlearrowleft fl_R^R \hookrightarrow X^\circlearrowleft f) \wedge (S^\circlearrowleft fl_S^S \hookrightarrow X^\circlearrowleft f). \quad (3.30)$$

- (ii) The negation of the subobject  $R^\circlearrowleft fl_R^R \hookrightarrow R^\circlearrowleft fl_R^R \vee S^\circlearrowleft fl_S^S$  with respect to the object  $R^\circlearrowleft fl_R^R \vee S^\circlearrowleft fl_S^S$  followed by inclusion in the object  $X^\circlearrowleft f$ , that is,

$$((R^\circlearrowleft fl_R^R \vee S^\circlearrowleft fl_S^S) \hookrightarrow X^\circlearrowleft f) \circ \neg(R^\circlearrowleft fl_R^R \hookrightarrow R^\circlearrowleft fl_R^R \vee S^\circlearrowleft fl_S^S), \quad (3.31)$$

where the object  $R^\circlearrowleft fl_R^R \vee S^\circlearrowleft fl_S^S$  is the domain of the subobject formed by the union of the subobjects  $R^\circlearrowleft fl_R^R \hookrightarrow X^\circlearrowleft f$  and  $S^\circlearrowleft fl_S^S \hookrightarrow X^\circlearrowleft f$ , that is,

$$R^\circlearrowleft fl_R^R \vee S^\circlearrowleft fl_S^S = \text{dom}((R^\circlearrowleft fl_R^R \hookrightarrow X^\circlearrowleft f) \vee (S^\circlearrowleft fl_S^S \hookrightarrow X^\circlearrowleft f)). \quad (3.32)$$

- (iii) The subobject  $S^\circlearrowleft fl_S^S \hookrightarrow X^\circlearrowleft f$  following subobject formed by the union of the collection of subobjects  $U^\circlearrowleft fl_U^U \hookrightarrow S^\circlearrowleft fl_S^S$  of the object  $S^\circlearrowleft fl_S^S$  which

when included in the object  $R^{\circlearrowleft} f|_R^R \vee S^{\circlearrowleft} f|_S^S$  are disjoint from the subobject  $R^{\circlearrowleft} f|_R^R \hookrightarrow R^{\circlearrowleft} f|_R^R \vee S^{\circlearrowleft} f|_S^S$ , that is,

$$\begin{aligned} & (S^{\circlearrowleft} f|_S^S \hookrightarrow X^{\circlearrowleft} f) \circ \bigvee \left\{ U^{\circlearrowleft} f|_U^U \hookrightarrow S^{\circlearrowleft} f|_S^S \mid \right. \\ & (S^{\circlearrowleft} f|_S^S \hookrightarrow R^{\circlearrowleft} f|_R^R \vee S^{\circlearrowleft} f|_S^S) \circ (U^{\circlearrowleft} f|_U^U \hookrightarrow S^{\circlearrowleft} f|_S^S) \\ & \left. \wedge (R^{\circlearrowleft} f|_R^R \hookrightarrow R^{\circlearrowleft} f|_R^R \vee S^{\circlearrowleft} f|_S^S) = (\emptyset^{\circlearrowleft} f|_{\emptyset}^{\emptyset} \hookrightarrow R^{\circlearrowleft} f|_R^R \vee S^{\circlearrowleft} f|_S^S) \right\}, \end{aligned} \quad (3.33)$$

where again

$$R^{\circlearrowleft} f|_R^R \vee S^{\circlearrowleft} f|_S^S = \text{dom}((R^{\circlearrowleft} f|_R^R \hookrightarrow X^{\circlearrowleft} f) \vee (S^{\circlearrowleft} f|_S^S \hookrightarrow X^{\circlearrowleft} f)). \quad (3.34)$$

Each of these definitions is considered in turn to demonstrate that they express the concept of removing one subobject from another subobject:

- (i) What subobject of the object  $X^{\circlearrowleft} f$  does the *negation* of the subobject  $R^{\circlearrowleft} f|_R^R \hookrightarrow X^{\circlearrowleft} f$  with respect to the object  $X^{\circlearrowleft} f$  identify?

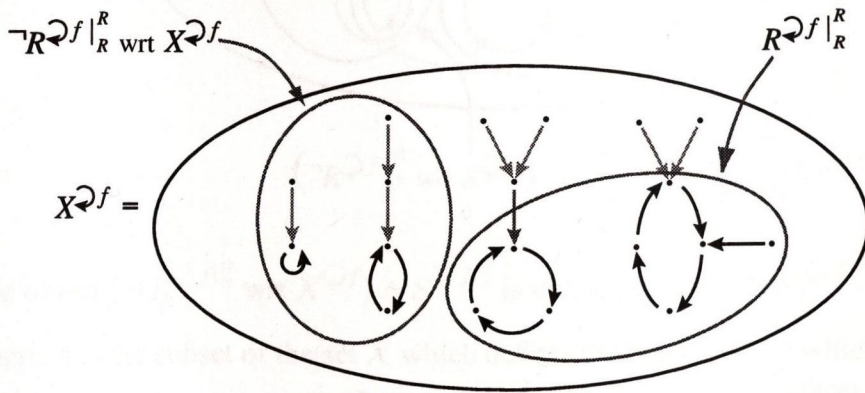

The object  $\neg R^{\circlearrowleft} f|_R^R \text{ wrt } X^{\circlearrowleft} f$  is defined to be the object  $A^{\circlearrowleft} f|_A^A$  where  $A$  is the subset of the set  $X$  which contains only those elements  $x$  of the set  $X$  which never 'enter' the subset  $R$  under repeated applications of  $f$ , that is,

$$A = \{x \in X \mid \forall n \in \mathbb{N}: f^n x \notin R\}. \quad (3.35)$$



The object  $A \curvearrowright f|_A^A$  is a subobject of the object  $X \curvearrowright f$ . Thus the object  $\neg R \curvearrowright f|_R^R \text{ wrt } X \curvearrowright f$  is a subobject of the object  $X \curvearrowright f$ .

Hence, the negation of the subobject  $R \curvearrowright f|_R^R \hookrightarrow X \curvearrowright f$  with respect to the object  $X \curvearrowright f$  is defined by

$$\neg(R \curvearrowright f|_R^R \hookrightarrow X \curvearrowright f) = \neg R \curvearrowright f|_R^R \text{ wrt } X \curvearrowright f \hookrightarrow X \curvearrowright f. \quad (3.36)$$

What subobject of the object  $X \curvearrowright f$  does the *intersection* of the subobject  $\neg(R \curvearrowright f|_R^R \hookrightarrow X \curvearrowright f)$  with the subobject  $S \curvearrowright f|_S^S \hookrightarrow X \curvearrowright f$  identify?

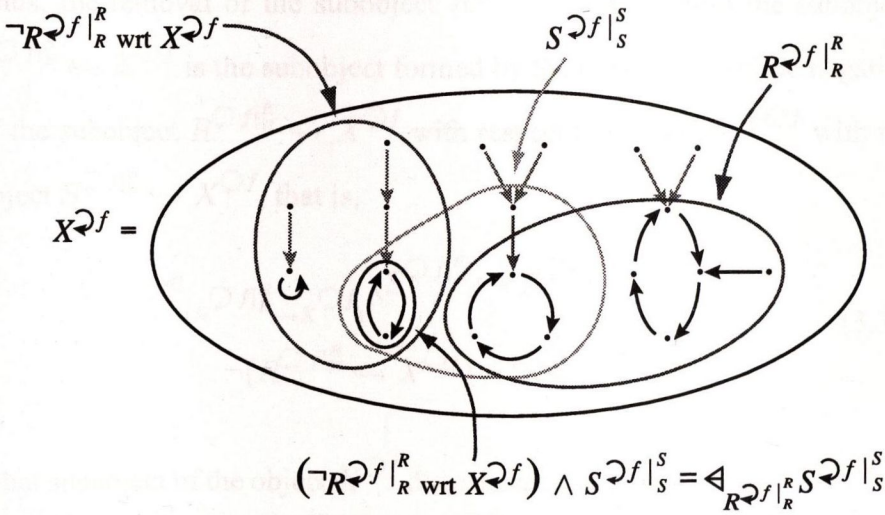

The object  $(\neg R \curvearrowright f|_R^R \text{ wrt } X \curvearrowright f) \wedge S \curvearrowright f|_S^S$  is defined to be  $(A \cap S) \curvearrowright f|_{(A \cap S)}^{(A \cap S)}$  where  $A$  is the subset of the set  $X$  which defines the object  $A \curvearrowright f|_A^A$  which in turn defines the object  $\neg R \curvearrowright f|_R^R \text{ wrt } X \curvearrowright f$ . The object  $(A \cap S) \curvearrowright f|_{(A \cap S)}^{(A \cap S)}$  is a subobject of the object  $X \curvearrowright f$ , thus the object  $(\neg R \curvearrowright f|_R^R \text{ wrt } X \curvearrowright f) \wedge S \curvearrowright f|_S^S$  is a subobject of the object  $X \curvearrowright f$ . Additionally,  $(\neg R \curvearrowright f|_R^R \text{ wrt } X \curvearrowright f) \wedge S \curvearrowright f|_S^S$  is a subobject of both the objects  $\neg R \curvearrowright f|_R^R \text{ wrt } X \curvearrowright f$  and  $S \curvearrowright f|_S^S$ .

Hence, the intersection of the subobject  $\neg(R \circlearrowleft f|_R^R \hookrightarrow X \circlearrowleft f)$  with the subobject  $S \circlearrowleft f|_S^S \hookrightarrow X \circlearrowleft f$  is defined by

$$\begin{aligned} \neg(R \circlearrowleft f|_R^R \hookrightarrow X \circlearrowleft f) \wedge (S \circlearrowleft f|_S^S \hookrightarrow X \circlearrowleft f) = \\ ((\neg R \circlearrowleft f|_R^R \text{ wrt } X \circlearrowleft f) \wedge S \circlearrowleft f|_S^S) \hookrightarrow X \circlearrowleft f. \end{aligned} \tag{3.37}$$

Since  $A \cap S = T$  where  $T$  is the subset of the set  $X$  which is defining the object  $f|_T^T$  which in turn defines the object  $\triangleleft_{R \circlearrowleft f|_R^R} S \circlearrowleft f|_S^S$ , then  $((\neg R \circlearrowleft f|_R^R \text{ wrt } X \circlearrowleft f) \wedge S \circlearrowleft f|_S^S) = \triangleleft_{R \circlearrowleft f|_R^R} S \circlearrowleft f|_S^S$ .

Thus, the removal of the subobject  $R \circlearrowleft f|_R^R \hookrightarrow X \circlearrowleft f$  from the subobject  $S \circlearrowleft f|_S^S \hookrightarrow X \circlearrowleft f$  is the subobject formed by the intersection of the negation of the subobject  $R \circlearrowleft f|_R^R \hookrightarrow X \circlearrowleft f$  with respect to the object  $X \circlearrowleft f$  with the object  $S \circlearrowleft f|_S^S \hookrightarrow X \circlearrowleft f$ , that is,

$$\begin{aligned} \triangleleft_{(R \circlearrowleft f|_R^R \hookrightarrow X \circlearrowleft f)} (S \circlearrowleft f|_S^S \hookrightarrow X \circlearrowleft f) = \\ \neg(R \circlearrowleft f|_R^R \hookrightarrow X \circlearrowleft f) \wedge (S \circlearrowleft f|_S^S \hookrightarrow X \circlearrowleft f). \end{aligned} \tag{3.38}$$

(ii) What subobject of the object  $X \circlearrowleft f$  does the union of the subobject  $R \circlearrowleft f|_R^R \hookrightarrow X \circlearrowleft f$  with the subobject  $S \circlearrowleft f|_S^S \hookrightarrow X \circlearrowleft f$  identify?

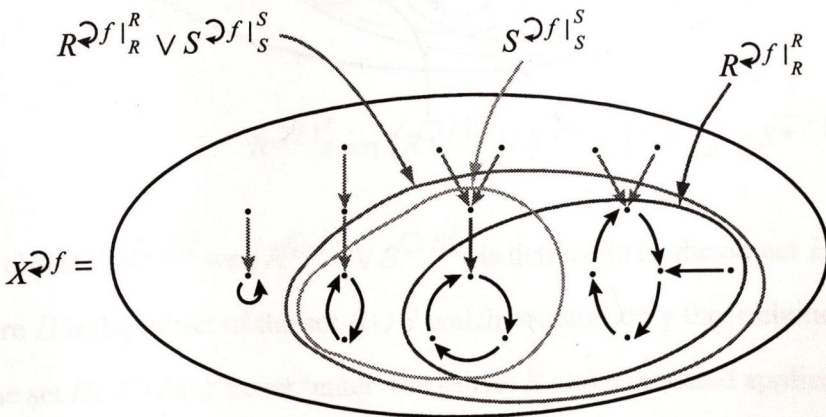



The object  $R \circlearrowleft f|_R^R \vee S \circlearrowleft f|_S^S$  is defined to be the object  $(R \cup S) \circlearrowleft f|_{(R \cup S)}^{(R \cup S)}$ . The object  $(R \cup S) \circlearrowleft f|_{(R \cup S)}^{(R \cup S)}$  is a subobject of the object  $X \circlearrowleft f$ . Thus the object  $R \circlearrowleft f|_R^R \vee S \circlearrowleft f|_S^S$  is a subobject of the object  $X \circlearrowleft f$ . Additionally, the objects  $R \circlearrowleft f|_R^R$  and  $S \circlearrowleft f|_S^S$  are subobjects of the object  $R \circlearrowleft f|_R^R \vee S \circlearrowleft f|_S^S$ .

Hence, the union of the subobject  $R \circlearrowleft f|_R^R \hookrightarrow X \circlearrowleft f$  with the subobject  $S \circlearrowleft f|_S^S \hookrightarrow X \circlearrowleft f$  is defined by

$$\begin{aligned} (R \circlearrowleft f|_R^R \hookrightarrow X \circlearrowleft f) \vee (S \circlearrowleft f|_S^S \hookrightarrow X \circlearrowleft f) = \\ R \circlearrowleft f|_R^R \vee S \circlearrowleft f|_S^S \hookrightarrow X \circlearrowleft f. \end{aligned} \tag{3.39}$$

What subobject of the object  $R \circlearrowleft f|_R^R \vee S \circlearrowleft f|_S^S$  does the *negation* of the subobject  $R \circlearrowleft f|_R^R \hookrightarrow R \circlearrowleft f|_R^R \vee S \circlearrowleft f|_S^S$  with respect to the object  $R \circlearrowleft f|_R^R \vee S \circlearrowleft f|_S^S$  identify?

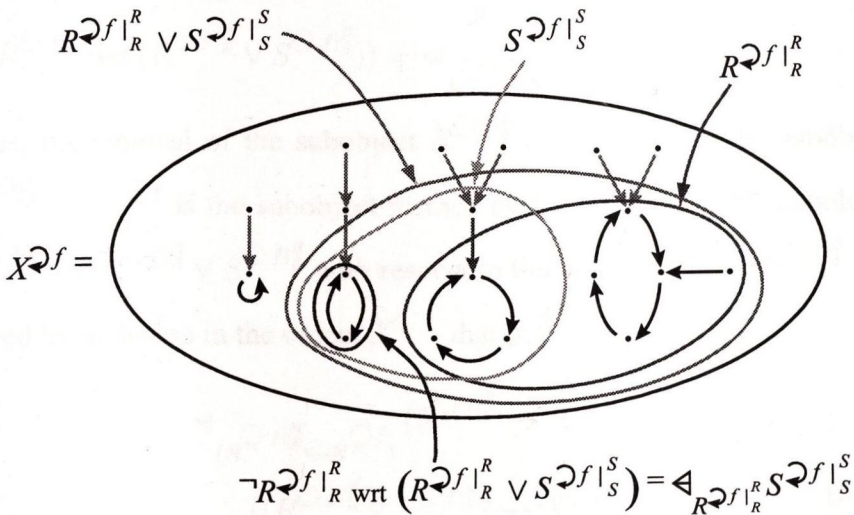

The object  $\neg R \circlearrowleft f|_R^R \text{ wrt } (R \circlearrowleft f|_R^R \vee S \circlearrowleft f|_S^S)$  is defined to be the object  $B \circlearrowleft f|_B^B$  where  $B$  is the subset of the set  $R \cup S$  which contains only those elements  $x$  of the set  $R \cup S$  which never ‘enter’ the subset  $R$  under repeated applications

of  $f$ , that is,

$$B = \{x \in R \cup S \mid \forall n \in \mathbb{N}: f^n x \notin R\}. \quad (3.40)$$

The object  $B^{\circlearrowleft} f|_B^B$  is a subobject of the object  $R^{\circlearrowleft} f|_R^R \vee S^{\circlearrowleft} f|_S^S$ . Thus the object  $\neg R^{\circlearrowleft} f|_R^R \text{ wrt } (R^{\circlearrowleft} f|_R^R \vee S^{\circlearrowleft} f|_S^S)$  is a subobject of the object  $R^{\circlearrowleft} f|_R^R \vee S^{\circlearrowleft} f|_S^S$ .

Hence, the negation of the subobject  $R^{\circlearrowleft} f|_R^R \hookrightarrow R^{\circlearrowleft} f|_R^R \vee S^{\circlearrowleft} f|_S^S$  with respect to the object  $R^{\circlearrowleft} f|_R^R \vee S^{\circlearrowleft} f|_S^S$  is defined by

$$\begin{aligned} \neg(R^{\circlearrowleft} f|_R^R \hookrightarrow R^{\circlearrowleft} f|_R^R \vee S^{\circlearrowleft} f|_S^S) = \\ \neg R^{\circlearrowleft} f|_R^R \text{ wrt } (R^{\circlearrowleft} f|_R^R \vee S^{\circlearrowleft} f|_S^S) \hookrightarrow R^{\circlearrowleft} f|_R^R \vee S^{\circlearrowleft} f|_S^S. \end{aligned} \quad (3.41)$$

Since  $B = T$  where  $T$  is the subset of the set  $X$  which is defining the object  $f|_T^T$  which in turn defines the object  $\triangleleft_{R^{\circlearrowleft} f|_R^R} S^{\circlearrowleft} f|_S^S$ , then it is clear that  $(\neg R^{\circlearrowleft} f|_R^R \text{ wrt } (R^{\circlearrowleft} f|_R^R \vee S^{\circlearrowleft} f|_S^S)) = \triangleleft_{R^{\circlearrowleft} f|_R^R} S^{\circlearrowleft} f|_S^S$ .

Thus, the removal of the subobject  $R^{\circlearrowleft} f|_R^R \hookrightarrow X^{\circlearrowleft} f$  from the subobject  $S^{\circlearrowleft} f|_S^S \hookrightarrow X^{\circlearrowleft} f$  is the subobject formed by the negation of the subobject  $R^{\circlearrowleft} f|_R^R \hookrightarrow R^{\circlearrowleft} f|_R^R \vee S^{\circlearrowleft} f|_S^S$  with respect to the object  $R^{\circlearrowleft} f|_R^R \vee S^{\circlearrowleft} f|_S^S$  followed by inclusion in the object  $X^{\circlearrowleft} f$ , that is,

$$\begin{aligned} \triangleleft_{(R^{\circlearrowleft} f|_R^R \hookrightarrow X^{\circlearrowleft} f)} (S^{\circlearrowleft} f|_S^S \hookrightarrow X^{\circlearrowleft} f) = \\ ((R^{\circlearrowleft} f|_R^R \vee S^{\circlearrowleft} f|_S^S) \hookrightarrow X^{\circlearrowleft} f) \\ \circ \neg(R^{\circlearrowleft} f|_R^R \hookrightarrow R^{\circlearrowleft} f|_R^R \vee S^{\circlearrowleft} f|_S^S). \end{aligned} \quad (3.42)$$

(iii) What are the subobjects  $U^{\circlearrowleft} f|_U^U \hookrightarrow S^{\circlearrowleft} f|_S^S$  of the object  $S^{\circlearrowleft} f|_S^S$  which when included in the object  $R^{\circlearrowleft} f|_R^R \vee S^{\circlearrowleft} f|_S^S$  are disjoint from the subobject  $R^{\circlearrowleft} f|_R^R \hookrightarrow$



$R \circlearrowleft f_{R \vee S}^R \vee S \circlearrowleft f_S^S$ ? Consider the Heyting algebra of parts of the object  $R \circlearrowleft f_{R \vee S}^R \vee S \circlearrowleft f_S^S$ .

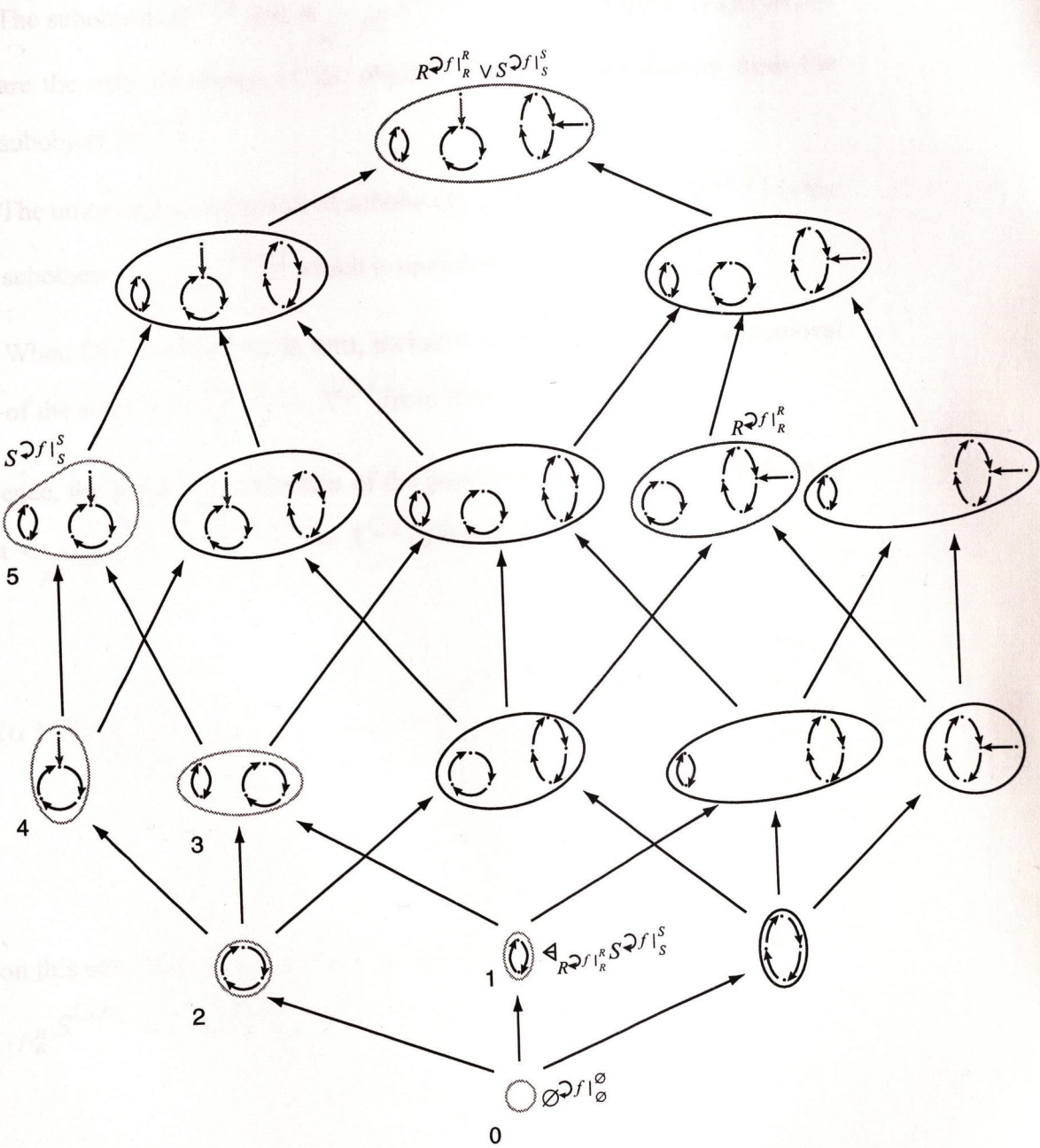

We can clearly see, contained within this Heyting algebra, the collection of subobjects of the object  $S \circlearrowleft f_S^S$ . These subobjects are numbered 0 through

5 for ease of reference.

We want to ask which of these subobjects is disjoint from the object  $R \circlearrowleft f|_R^R$ ?

The subobjects  $\emptyset \circlearrowleft f|_0^\emptyset$  and  $\triangleleft_{R \circlearrowleft f|_R^R} S \circlearrowleft f|_S^S$ , numbered 0 and 1, respectively, are the only subobjects of the object  $S \circlearrowleft f|_S^S$  which are disjoint from the subobject  $R \circlearrowleft f|_R^R$ .

The union of this collection of subobjects  $\bigvee \{ \emptyset \circlearrowleft f|_0^\emptyset, \triangleleft_{R \circlearrowleft f|_R^R} S \circlearrowleft f|_S^S \}$  is the subobject  $\triangleleft_{R \circlearrowleft f|_R^R} S \circlearrowleft f|_S^S$  which is included in  $S \circlearrowleft f|_S^S \vee R \circlearrowleft f|_R^R$ .

When this subobject is, in turn, included in  $X \circlearrowleft f$  the result is the removal of the subobject  $R \circlearrowleft f|_R^R \hookrightarrow X \circlearrowleft f$  from the subobject  $S \circlearrowleft f|_S^S$ .

Hence, the domain of definition of the partial map  $X \circlearrowleft f \xrightarrow{\alpha \dagger \beta} Y \circlearrowleft g$  is the subobject  $\triangleleft_{R \circlearrowleft f|_R^R} S \circlearrowleft f|_S^S \vee R \circlearrowleft f|_R^R \hookrightarrow X \circlearrowleft f$  of the object  $X \circlearrowleft f$ :

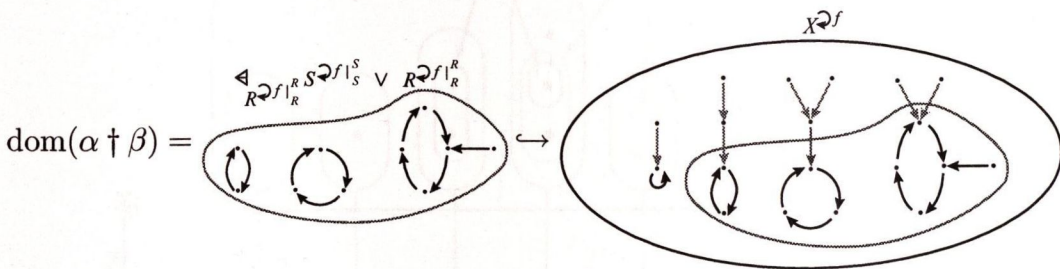

and on this subobject the partial map is defined by the following  $\mathcal{S} \circlearrowleft$ -map

$$\triangleleft_{R \circlearrowleft f|_R^R} S \circlearrowleft f|_S^S \vee R \circlearrowleft f|_R^R \xrightarrow{\alpha \dagger \beta} Y \circlearrowleft g.$$

Where  $f|_R^R$  and  $f|_S^S$  are subobjects in the category  $\mathcal{S} \circlearrowleft$  and  $f$  is a subobject in the category  $\mathcal{S} \circlearrowleft$ .



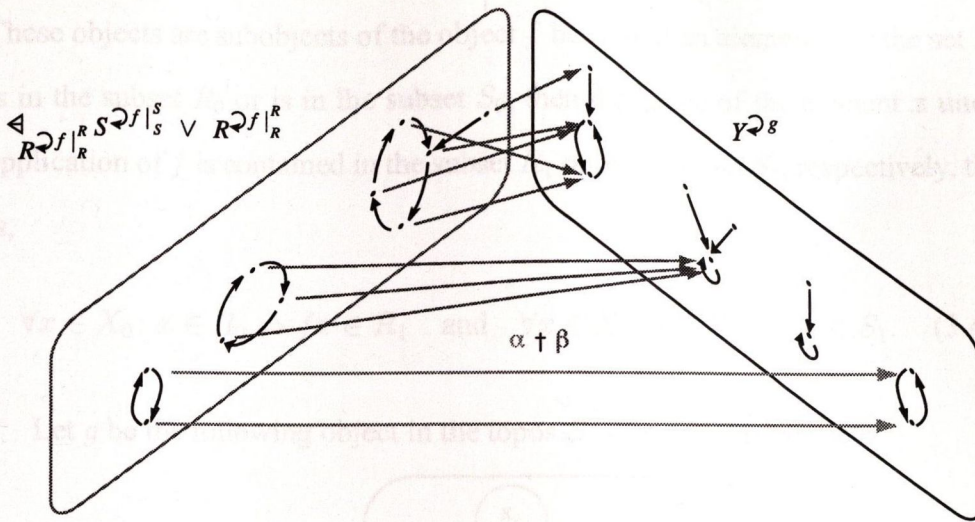

### 3.6 Topos of Mappings between Sets

Let  $f$  be the following object in the topos  $\mathcal{S}^{\downarrow}$  of mappings between sets:

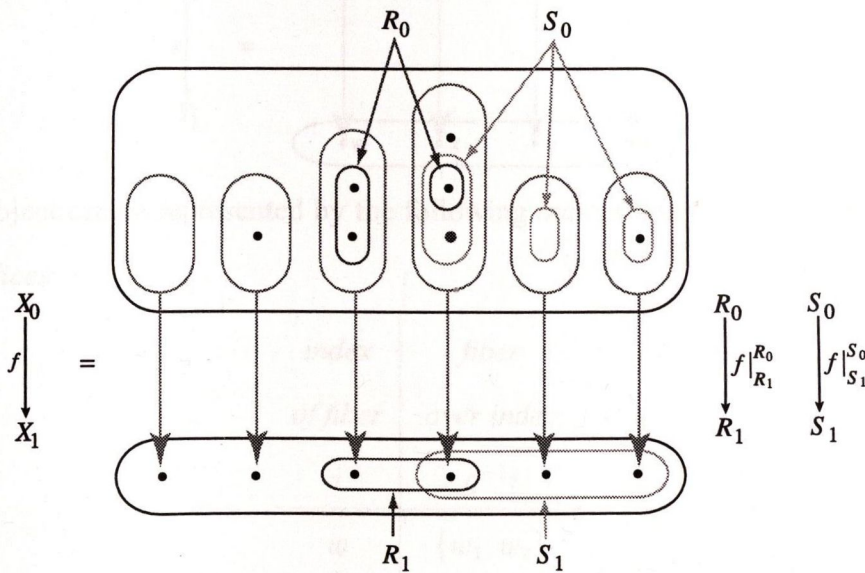

Where  $f|_{R_1}^{R_0}$  and  $f|_{S_1}^{S_0}$  are also objects in the topos  $\mathcal{S}^{\downarrow}$  of maps between sets, these objects are subobjects of the object  $f$ , that is,

$$f|_{R_1}^{R_0} \hookrightarrow f \quad \text{and} \quad f|_{S_1}^{S_0} \hookrightarrow f. \tag{3.43}$$

These objects are subobjects of the object  $f$  because if an element  $x$  of the set  $X_0$  is in the subset  $R_0$  or is in the subset  $S_0$ , then the image of the element  $x$  under application of  $f$  is contained in the subset  $R_1$  or in the subset  $S_1$ , respectively, that is,

$$\forall x \in X_0: x \in R_0 \Rightarrow fx \in R_1 \quad \text{and} \quad \forall x \in X_0: x \in S_0 \Rightarrow fx \in S_1. \quad (3.44)$$

Let  $g$  be the following object in the topos  $\mathcal{S}^\downarrow$  of maps between sets:

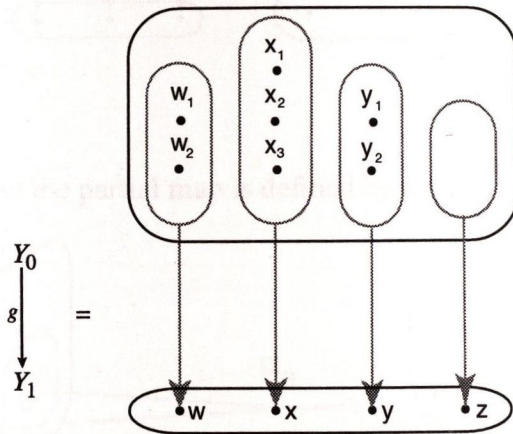

This object can be represented by the following *indices* and *fibers of germs over the indices*:

<i>index</i>	<i>fiber</i>
<i>of fiber</i>	<i>over index</i>
$i$	$g^{-1}i$
$w$	$\{w_1, w_2\}$
$x$	$\{x_1, x_2, x_3\}$
$y$	$\{y_1, y_2\}$
$z$	$\emptyset$



Let  $f \overset{\alpha}{\rightsquigarrow} g$  be an  $\mathcal{S}^\downarrow$ -partial map whose domain of definition is the subobject  $f|_{S_1}^{S_0} \hookrightarrow f$  of the object  $f$ :

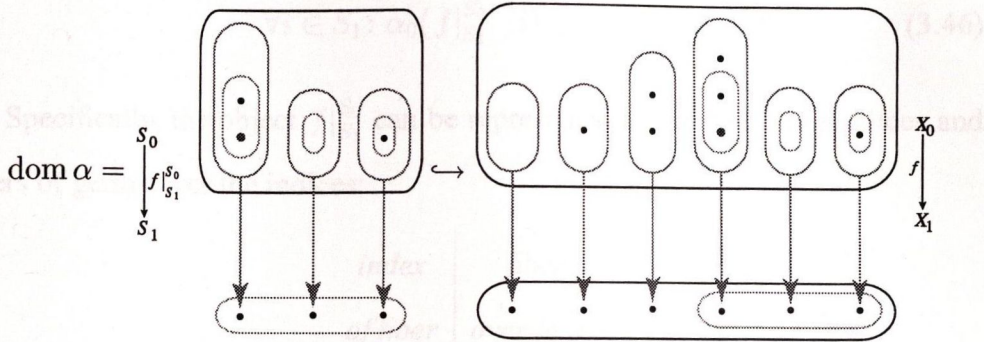

and on this subobject the partial map is defined by the  $\mathcal{S}^\downarrow$ -map  $f|_{S_1}^{S_0} \overset{\alpha}{\rightsquigarrow} g$ :

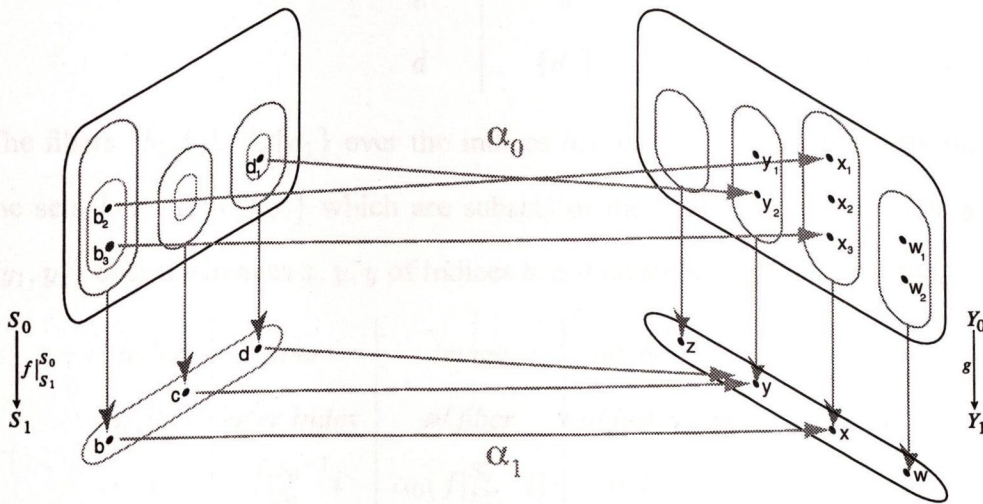

This map consists of two  $\mathcal{S}$ -maps  $S_0 \xrightarrow{\alpha_0} Y_0$ ,  $S_1 \xrightarrow{\alpha_1} Y_1$  which ‘respect the map structure’, that is,

$$\alpha_1 \circ f|_{S_1}^{S_0} = g \circ \alpha_0. \tag{3.45}$$

Why do the  $\mathcal{S}$ -maps  $S_0 \xrightarrow{\alpha_0} Y_0$ ,  $S_1 \xrightarrow{\alpha_1} Y_1$  preserve the fiber structure of the domains  $S_0, S_1$ ? The  $\mathcal{S}$ -maps preserve the fiber structure because the fiber over

each index  $i$  in  $f|_{S_1}^{S_0}$  is mapped by  $\alpha_0$  into the fiber over the image of index  $i$  under application of  $\alpha_1$  in  $g$ , that is,

$$\forall i \in S_1: \alpha_0(f|_{S_1}^{S_0^{-1}} i) \subseteq g^{-1}\alpha_1 i. \tag{3.46}$$

Specifically, the object  $f|_{S_1}^{S_0}$  can be represented by the following indices and fibers of germs over the indices:

<i>index of fiber</i>	<i>fiber over index</i>
$i$	$f _{S_1}^{S_0^{-1}} i$
$b$	$\{b_2, b_3\}$
$c$	$\emptyset$
$d$	$\{d_1\}$

The fibers  $\{b_2, b_3\}, \emptyset, \{d_1\}$  over the indices  $b, c, d$  in  $f|_{S_1}^{S_0}$  are mapped by  $\alpha_0$  to the sets  $\{x_1, x_3\}, \emptyset, \{y_2\}$  which are subsets of the fibers  $\{x_1, x_2, x_3\}, \{y_1, y_2\}, \{y_1, y_2\}$  over the images  $x, y, y$  of indices  $b, c, d$  under application of  $\alpha_1$  in  $g$ :

<i>index of fiber</i>	<i>fiber over index</i>	<i>image of fiber</i>	<i>image of index</i>	<i>fiber over image of index</i>
$i$	$f _{S_1}^{S_0^{-1}} i$	$\alpha_0(f _{S_1}^{S_0^{-1}} i)$	$\alpha_1 i$	$g^{-1}\alpha_1 i$
$b$	$\{b_2, b_3\}$	$\{x_1, x_3\}$	$x$	$\{x_1, x_2, x_3\}$
$c$	$\emptyset$	$\emptyset$	$y$	$\{y_1, y_2\}$
$d$	$\{d_1\}$	$\{y_2\}$	$y$	$\{y_1, y_2\}$



Let  $f \xrightarrow{\beta} g$  be an  $\mathcal{S}^\downarrow$ -partial map whose domain of definition is the subobject  $f|_{R_1}^{R_0} \hookrightarrow f$  of the object  $f$ :

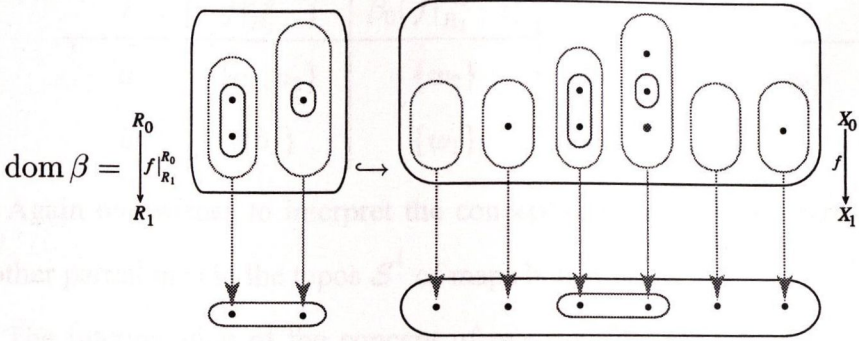

and on this subobject the partial map is defined by the  $\mathcal{S}^\downarrow$ -map  $f|_{R_1}^{R_0} \xrightarrow{\beta} g$ :

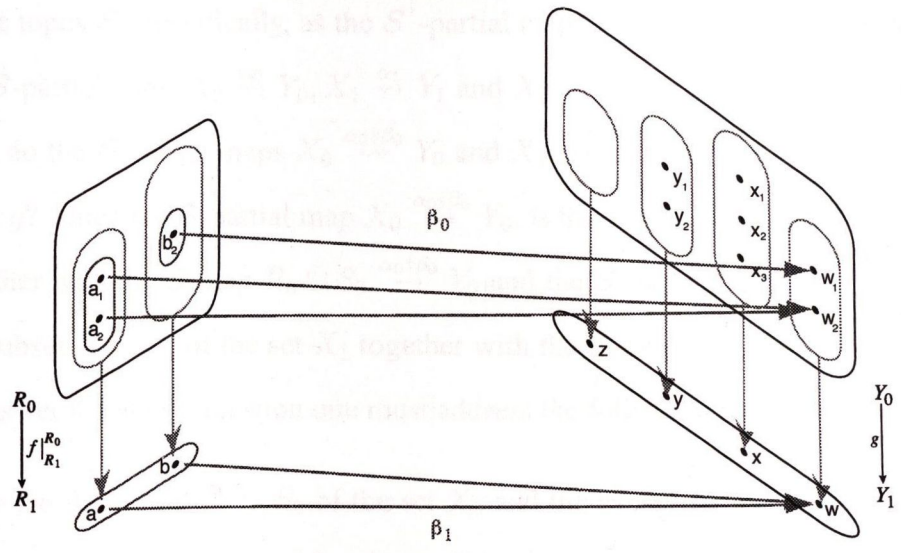

This map consists of two  $\mathcal{S}$ -maps  $R_0 \xrightarrow{\beta_0} Y_0, R_1 \xrightarrow{\beta_1} Y_1$  which ‘respect the map structure’, that is,

$$\beta_1 \circ f|_{R_1}^{R_0} = g \circ \beta_0. \tag{3.47}$$

Once again, the  $\mathcal{S}$ -maps  $R_0 \xrightarrow{\beta_0} Y_0, R_1 \xrightarrow{\beta_1} Y_1$  preserve the fiber structure because the fiber over each index  $i$  in  $f|_{R_1}^{R_0}$  is mapped by  $\beta_0$  into the fiber over the image of index  $i$  under application of  $\beta_1$  in  $g$ :

<i>index of fiber</i>	<i>fiber over index</i>	<i>image of fiber</i>	<i>image of index</i>	<i>fiber over image of index</i>
$i$	$f _{R_1}^{R_0^{-1}} i$	$\beta_0(f _{R_1}^{R_0^{-1}} i)$	$\beta_1 i$	$g^{-1} \beta_1 i$
$a$	$\{a_1, a_2\}$	$\{w_2\}$	$w$	$\{w_1, w_2\}$
$b$	$\{b_2\}$	$\{w_1\}$	$w$	$\{w_1, w_2\}$

Again one wishes to interpret the concept of overriding one partial map by another partial map in the topos  $\mathcal{S}^\downarrow$  of maps between sets.

The interpretation of the concept of overriding one partial map by another partial map in the topos  $\mathcal{S}^\downarrow$  of maps between sets is different from its interpretation in the topos  $\mathcal{S}$ . Specifically, as the  $\mathcal{S}^\downarrow$ -partial maps  $f \overset{\alpha}{\rightsquigarrow} g$  and  $f \overset{\beta}{\rightsquigarrow} g$  give rise to the  $\mathcal{S}$ -partial maps  $X_0 \overset{\alpha_0}{\rightsquigarrow} Y_0, X_1 \overset{\alpha_1}{\rightsquigarrow} Y_1$  and  $X_0 \overset{\beta_0}{\rightsquigarrow} Y_0, X_1 \overset{\beta_1}{\rightsquigarrow} Y_1$ , in the obvious way, do the  $\mathcal{S}$ -partial maps  $X_0 \overset{\alpha_0 \uparrow \beta_0}{\rightsquigarrow} Y_0$  and  $X_1 \overset{\alpha_1 \uparrow \beta_1}{\rightsquigarrow} Y_1$  form an  $\mathcal{S}^\downarrow$ -partial map  $f \rightsquigarrow g$ ? Since the  $\mathcal{S}$ -partial map  $X_0 \overset{\alpha_0 \uparrow \beta_0}{\rightsquigarrow} Y_0$ , is the subset  $R_0 \cup S_0$  of the set  $X_0$  together with the  $\mathcal{S}$ -map  $R_0 \cup S_0 \xrightarrow{\alpha_0 \uparrow \beta_0} Y_0$  and the  $\mathcal{S}$ -partial map  $X_1 \overset{\alpha_1 \uparrow \beta_1}{\rightsquigarrow} Y_1$ , is the subset  $R_1 \cup S_1$  of the set  $X_1$  together with the  $\mathcal{S}$ -map  $R_1 \cup S_1 \xrightarrow{\alpha_1 \uparrow \beta_1} Y_1$ , then to answer the above question one must address the following two questions:

- (i) Do the subset  $R_0 \cup S_0$  of the set  $X_0$  and the subset  $R_1 \cup S_1$  of the set  $X_1$  identify a subobject of the object  $f$ ?

The subset  $R_0 \cup S_0$  of the set  $X_0$  and the subset  $R_1 \cup S_1$  of the set  $X_1$  gives



rise to the subobject  $f|_{(R_1 \cup S_1)}^{(R_0 \cup S_0)} \hookrightarrow f$  of the object  $f$ :

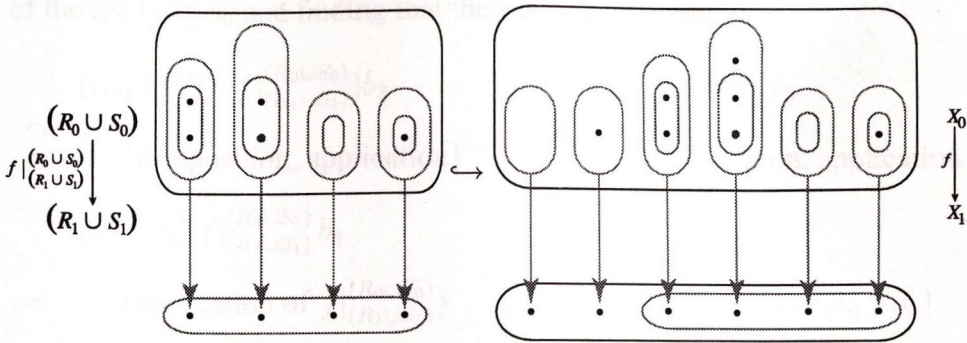

This is because if an element  $x$  of the set  $X_0$  is in the subset  $R_0 \cup S_0$ , then the image of the element  $x$  under application of  $f$  is contained in the subset  $R_1 \cup S_1$ .

(ii) Do the  $\mathcal{S}$ -maps  $R_0 \cup S_0 \xrightarrow{\alpha_0 \dagger \beta_0} Y_0$  and  $R_1 \cup S_1 \xrightarrow{\alpha_1 \dagger \beta_1} Y_1$  form an  $\mathcal{S}$ -map

$$f|_{(R_1 \cup S_1)}^{(R_0 \cup S_0)} \rightarrow g?$$

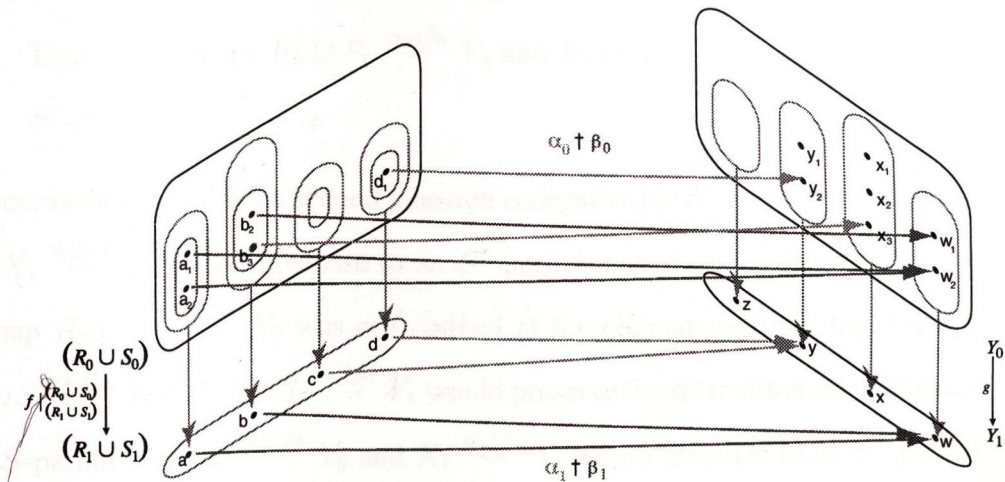

The following argument demonstrates that the fiber structure is not preserved by the  $\mathcal{S}$ -maps  $R_0 \cup S_0 \xrightarrow{\alpha_0 \dagger \beta_0} Y_0$  and  $R_1 \cup S_1 \xrightarrow{\alpha_1 \dagger \beta_1} Y_1$  by evaluating

each composite map  $(\alpha_1 \dagger \beta_1) \circ f|_{(R_1 \cup S_1)}^{(R_0 \cup S_0)}$  and  $g \circ (\alpha_0 \dagger \beta_0)$  at the element  $b_3$  of the set  $R_0 \cup S_0$  and finding that their results disagree:

$$\begin{aligned}
 & ((\alpha_1 \dagger \beta_1) \circ f|_{(R_1 \cup S_1)}^{(R_0 \cup S_0)})b_3 && (g \circ (\alpha_0 \dagger \beta_0))b_3 \\
 = & \{\text{composition, application}\} && \{\text{composition, application}\} \\
 & (\alpha_1 \dagger \beta_1) f|_{(R_1 \cup S_1)}^{(R_0 \cup S_0)} b_3 && g(\alpha_0 \dagger \beta_0)b_3 \\
 = & \{\text{application of } f|_{(R_1 \cup S_1)}^{(R_0 \cup S_0)}\} && \{\text{application of } \alpha_0 \dagger \beta_0\} \\
 & (\alpha_1 \dagger \beta_1)b && gx_3 \\
 = & \{\text{application of } \alpha_1 \dagger \beta_1\} && \{\text{diagram}\} \\
 & w && x
 \end{aligned}$$

The  $\mathcal{S}$ -maps  $R_0 \cup S_0 \xrightarrow{\alpha_0 \dagger \beta_0} Y_0$  and  $R_1 \cup S_1 \xrightarrow{\alpha_1 \dagger \beta_1} Y_1$  do not respect the fiber structure, that is,

$$(\alpha_1 \dagger \beta_1) \circ f|_{(R_1 \cup S_1)}^{(R_0 \cup S_0)} \neq g \circ (\alpha_0 \dagger \beta_0). \tag{3.48}$$

Thus, the  $\mathcal{S}$ -maps  $R_0 \cup S_0 \xrightarrow{\alpha_0 \dagger \beta_0} Y_0$  and  $R_1 \cup S_1 \xrightarrow{\alpha_1 \dagger \beta_1} Y_1$  do not form an  $\mathcal{S}^\downarrow$ -map  $f|_{(R_1 \cup S_1)}^{(R_0 \cup S_0)} \rightarrow g$ .

Hence, as the answer to the second question is negative the  $\mathcal{S}$ -partial maps  $X_0 \xrightarrow{\alpha_0 \dagger \beta_0} Y_0$ ,  $X_1 \xrightarrow{\alpha_1 \dagger \beta_1} Y_1$  do not give rise to an  $\mathcal{S}^\downarrow$ -partial map  $f \rightsquigarrow g$ . However, if the  $\mathcal{S}$ -map  $R_0 \cup S_0 \xrightarrow{\alpha_0 \dagger \beta_0} Y_0$  was not defined at the element  $b_3$ , then the  $\mathcal{S}$ -maps  $R_0 \cup S_0 \xrightarrow{\alpha_0 \dagger \beta_0} Y_0$  and  $R_1 \cup S_1 \xrightarrow{\alpha_1 \dagger \beta_1} Y_1$  would preserve the fiber structure and hence the  $\mathcal{S}$ -partial maps  $X_0 \xrightarrow{\alpha_0 \dagger \beta_0} Y_0$  and  $X_1 \xrightarrow{\alpha_1 \dagger \beta_1} Y_1$  would give rise to an  $\mathcal{S}^\downarrow$ -partial map  $f \rightsquigarrow g$ .

Why does the interpretation of the concept of overriding one partial map by another partial map in the topos  $\mathcal{S}^\downarrow$  differ from its interpretation in the topos  $\mathcal{S}$ ?



As override depends on removal and extension, one must interpret the concepts of removal and extension in the topos  $\mathcal{S}^\downarrow$  of maps between sets in order to interpret the concept of override.

The interpretation of the concept of extending one partial map by another partial map in the topos  $\mathcal{S}^\downarrow$  is the same as its interpretation in the topos  $\mathcal{S}$ .

The concept of removing a subobject from a partial map depends upon the concept of removing one subobject from another subobject. Thus one must interpret the concept of removing one subobject from another subobject in the topos  $\mathcal{S}^\downarrow$ .

The interpretation of the concept of removing one subobject from another subobject in the topos  $\mathcal{S}^\downarrow$  is different from its interpretation in the topos  $\mathcal{S}$ . Specifically, as the subobjects  $f|_{R_1}^{R_0} \hookrightarrow f$  and  $f|_{S_1}^{S_0} \hookrightarrow f$  of the object  $f$  give rise to the subsets  $R_0$  and  $S_0$  of the set  $X_0$ , and the subsets  $R_1$  and  $S_1$  of the set  $X_1$ , in the obvious way, does the subset  $\triangleleft_{R_0} S_0$  of the set  $X_0$  together with the subset  $\triangleleft_{R_1} S_1$  of the set  $X_1$  identify a subobject of the object  $f$ ?

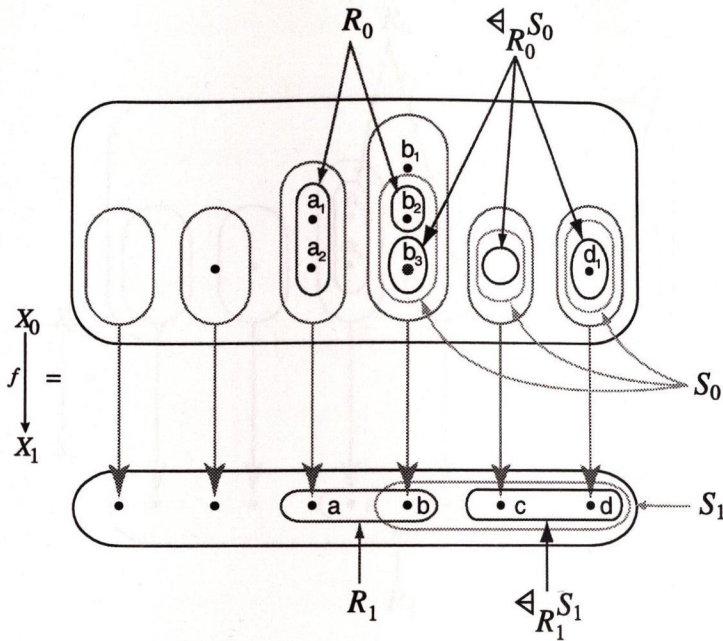

The subset  $\triangleleft_{R_0} S_0$  of the set  $X_0$  and the subset  $\triangleleft_{R_1} S_1$  of the set  $X_1$  do not identify a subobject of the object  $f$ . This is because the element  $b_3$  of the set  $X_0$  is contained in the subset  $\triangleleft_{R_0} S_0$  but is mapped outside of the subset  $\triangleleft_{R_1} S_1$  by an application of  $f$ , that is,  $b_3 \in \triangleleft_{R_0} S_0$  and yet  $fb_3 \notin \triangleleft_{R_1} S_1$ .

What subobject of the object  $f$  should the *removal* of the subobject  $f|_{R_1}^{R_0} \hookrightarrow f$  from the subobject  $f|_{S_1}^{S_0} \hookrightarrow f$  identify?

The object  $f|_{S_1}^{S_0} \hookrightarrow f$  is a subobject of the object  $f$ .

subobject of the object  $f$ . Additionally, the object  $f|_{R_1}^{R_0} \hookrightarrow f$  is a subobject of the object  $f$ .

object  $f$ , then  $f|_{R_1}^{R_0} \hookrightarrow f$  is a subobject of the object  $f|_{S_1}^{S_0} \hookrightarrow f$ .

Hence, the removal of the subobject  $f|_{R_1}^{R_0} \hookrightarrow f$  from the subobject  $f|_{S_1}^{S_0} \hookrightarrow f$  identifies the subobject  $f|_{S_1}^{S_0} \hookrightarrow f$ .

the subobject  $f|_{S_1}^{S_0} \hookrightarrow f$  is

The interpretation of the concept of removing the subobject from another subobject in the paper is different from the usual interpretation. Thus, the

object in the paper is different from the usual interpretation. Thus, the



interpretation of the concept of overriding one partial map by another partial map in the topos  $\mathcal{S}^\downarrow$  is different from its interpretation in the topos  $\mathcal{S}$ .

Why does the interpretation of the concept of removing one subobject from another subobject in the topos  $\mathcal{S}^\downarrow$  differ from its interpretation in the topos  $\mathcal{S}$ ? The concept of removing one subobject from another subobject depends upon the algebra of parts of an object, the algebra of parts of an object in the topos  $\mathcal{S}^\downarrow$  is a *Heyting algebra* whereas the algebra of parts of an object in the topos  $\mathcal{S}$  is a *Boolean algebra*. Additionally, the logic of the topos  $\mathcal{S}^\downarrow$  is *intuitionistic logic* whereas the logic of the topos  $\mathcal{S}$  is *classical logic*.

Specifically, the removal of the subobject  $f|_{R_1}^{R_0} \hookrightarrow f$  from the subobject  $f|_{S_1}^{S_0} \hookrightarrow f$  is defined using the algebra of parts by any one of the following three expressions:

- (i) The intersection of the negation of the subobject  $f|_{R_1}^{R_0} \hookrightarrow f$  with respect to the object  $f$  with the subobject  $f|_{S_1}^{S_0} \hookrightarrow f$ , that is,

$$\neg(f|_{R_1}^{R_0} \hookrightarrow f) \wedge (f|_{S_1}^{S_0} \hookrightarrow f). \quad (3.50)$$

- (ii) The negation of the subobject  $f|_{R_1}^{R_0} \hookrightarrow f|_{R_1}^{R_0} \vee f|_{S_1}^{S_0}$  with respect to the object  $f|_{R_1}^{R_0} \vee f|_{S_1}^{S_0}$  followed by inclusion in the object  $f$ , that is,

$$((f|_{R_1}^{R_0} \vee f|_{S_1}^{S_0}) \hookrightarrow f) \circ \neg(f|_{R_1}^{R_0} \hookrightarrow f|_{R_1}^{R_0} \vee f|_{S_1}^{S_0}), \quad (3.51)$$

where the object  $f|_{R_1}^{R_0} \vee f|_{S_1}^{S_0}$  is the domain of the subobject formed by the union of the subobjects  $f|_{R_1}^{R_0} \hookrightarrow f$  and  $f|_{S_1}^{S_0} \hookrightarrow f$ , that is,

$$f|_{R_1}^{R_0} \vee f|_{S_1}^{S_0} = \text{dom}((f|_{R_1}^{R_0} \hookrightarrow f) \vee (f|_{S_1}^{S_0} \hookrightarrow f)). \quad (3.52)$$

(iii) The subobject  $f|_{S_1}^{S_0} \hookrightarrow f$  following the subobject formed by the union of the collection of subobjects  $f|_{U_1}^{U_0} \hookrightarrow f|_{S_1}^{S_0}$  of the object  $f|_{S_1}^{S_0}$  which when included in the object  $f|_{R_1}^{R_0} \vee f|_{S_1}^{S_0}$  are disjoint from the subobject  $f|_{R_1}^{R_0} \hookrightarrow f|_{R_1}^{R_0} \vee f|_{S_1}^{S_0}$ , that is,

$$\begin{aligned}
 & (f|_{S_1}^{S_0} \hookrightarrow f) \circ \bigvee \left\{ f|_{U_1}^{U_0} \hookrightarrow f|_{S_1}^{S_0} \mid \right. \\
 & \left. ((f|_{S_1}^{S_0} \hookrightarrow f|_{R_1}^{R_0} \vee f|_{S_1}^{S_0}) \circ (f|_{U_1}^{U_0} \hookrightarrow f|_{S_1}^{S_0})) \right. \\
 & \left. \wedge (f|_{R_1}^{R_0} \hookrightarrow f|_{R_1}^{R_0} \vee f|_{S_1}^{S_0}) = (f|_{\emptyset}^{\emptyset} \hookrightarrow f|_{R_1}^{R_0} \vee f|_{S_1}^{S_0}) \right\}
 \end{aligned} \tag{3.53}$$

where again

$$f|_{R_1}^{R_0} \vee f|_{S_1}^{S_0} = \text{dom}((f|_{R_1}^{R_0} \hookrightarrow f) \vee (f|_{S_1}^{S_0} \hookrightarrow f)). \tag{3.54}$$

Each of these definitions is considered in turn to demonstrate that they express the concept of removing one subobject from another subobject:

- (i) What subobject of the object  $f$  does the *negation* of the subobject  $f|_{R_1}^{R_0} \hookrightarrow f$  with respect to the object  $f$  identify?

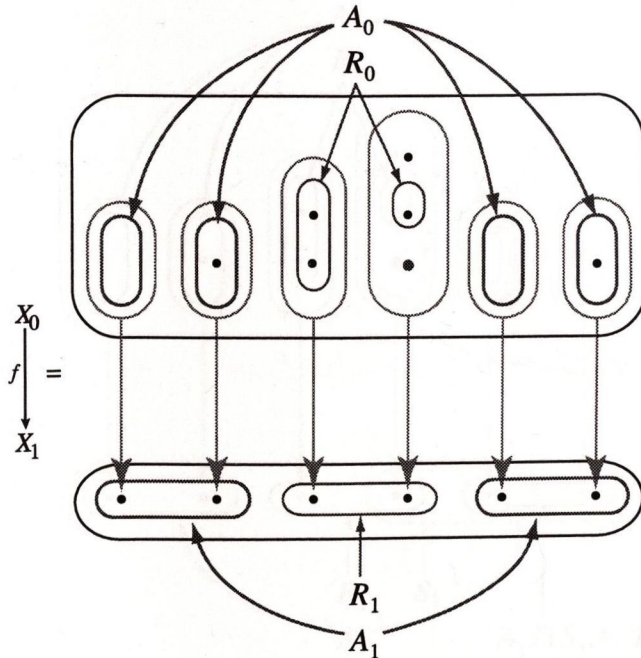



The object  $\neg f|_{R_1}^{R_0}$  wrt  $f$  is defined to be the object  $f|_{A_1}^{A_0}$  where  $A_0$  is the subset of the set  $X_0$  which contains only those elements  $x$  of the set  $X_0$  which are not mapped by  $f$  into the set  $R_1$  and where  $A_1$  is the subset of the set  $X_1$  which contains only those elements  $y$  of the set  $X_1$  which are not contained in the set  $R_1$ , that is,

$$A_0 = \{x \in X_0 \mid fx \notin R_1\} \quad \text{and} \quad A_1 = \complement_{R_1} X_1. \quad (3.55)$$

The object  $f|_{A_1}^{A_0}$  is a subobject of the object  $f$ . Thus the object  $\neg f|_{R_1}^{R_0}$  wrt  $f$  is a subobject of the object  $f$ .

Hence, the negation of the subobject  $f|_{R_1}^{R_0} \hookrightarrow f$  with respect to the object  $f$  is defined by

$$\neg(f|_{R_1}^{R_0} \hookrightarrow f) = \neg f|_{R_1}^{R_0} \text{ wrt } f \hookrightarrow f. \quad (3.56)$$

What subobject of the object  $f$  does the *intersection* of the subobject  $\neg(f|_{R_1}^{R_0} \hookrightarrow f)$  with the subobject  $f|_{S_1}^{S_0} \hookrightarrow f$  identify?

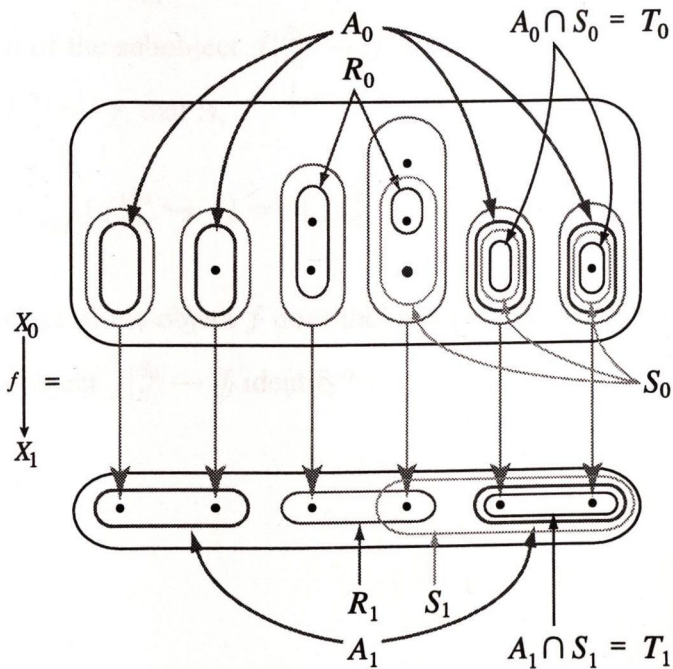

The object  $(\neg f|_{R_1}^{R_0} \text{ wrt } f) \wedge f|_{S_1}^{S_0}$  is defined to be the object  $f|_{(A_0 \cap S_1)}^{(A_0 \cap S_0)}$  where  $A_0$  and  $A_1$  are subsets of the set  $X_0$  and  $X_1$  respectively which define the object  $f|_{A_1}^{A_0}$  which in turn defines the object  $\neg f|_{R_1}^{R_0} \text{ wrt } f$ .

The object  $f|_{(A_0 \cap S_1)}^{(A_0 \cap S_0)}$  is a subobject of the object  $f$ . Thus  $(\neg f|_{R_1}^{R_0} \text{ wrt } f) \wedge f|_{S_1}^{S_0}$  is a subobject of the object  $f$ . Additionally,  $(\neg f|_{R_1}^{R_0} \text{ wrt } f) \wedge f|_{S_1}^{S_0}$  is a subobject of both  $\neg f|_{R_1}^{R_0} \text{ wrt } f$  and  $f|_{S_1}^{S_0}$ .

Hence, the intersection of the subobject  $\neg(f|_{R_1}^{R_0} \hookrightarrow f)$  with the subobject  $f|_{S_1}^{S_0} \hookrightarrow f$  is defined by

$$\neg(f|_{R_1}^{R_0} \hookrightarrow f) \wedge (f|_{S_1}^{S_0} \hookrightarrow f) = ((\neg f|_{R_1}^{R_0} \text{ wrt } f) \wedge f|_{S_1}^{S_0}) \hookrightarrow f. \quad (3.57)$$

Since  $A_0 \cap S_0 = T_0$  and  $A_1 \cap S_1 = T_1$  where  $T_0$  and  $T_1$  are the subsets of the sets  $X_0$  and  $X_1$  respectively which define the object  $f|_{T_1}^{T_0}$  which in turn defines the object  $\triangleleft_{f|_{R_1}^{R_0}} f|_{S_1}^{S_0}$ , then the removal of the subobject  $f|_{R_1}^{R_0} \hookrightarrow f$  from the subobject  $f|_{S_1}^{S_0} \hookrightarrow f$  is the subobject formed by the intersection of the negation of the subobject  $f|_{R_1}^{R_0} \hookrightarrow f$  with respect to the object  $f$  with the object  $f|_{S_1}^{S_0} \hookrightarrow f$ , that is,

$$\triangleleft_{(f|_{R_1}^{R_0} \hookrightarrow f)} (f|_{S_1}^{S_0} \hookrightarrow f) = \neg(f|_{R_1}^{R_0} \hookrightarrow f) \wedge (f|_{S_1}^{S_0} \hookrightarrow f). \quad (3.58)$$

- (ii) What subobject of the object  $f$  does the *union* of the subobject  $f|_{R_1}^{R_0} \hookrightarrow f$  with the subobject  $f|_{S_1}^{S_0} \hookrightarrow f$  identify?



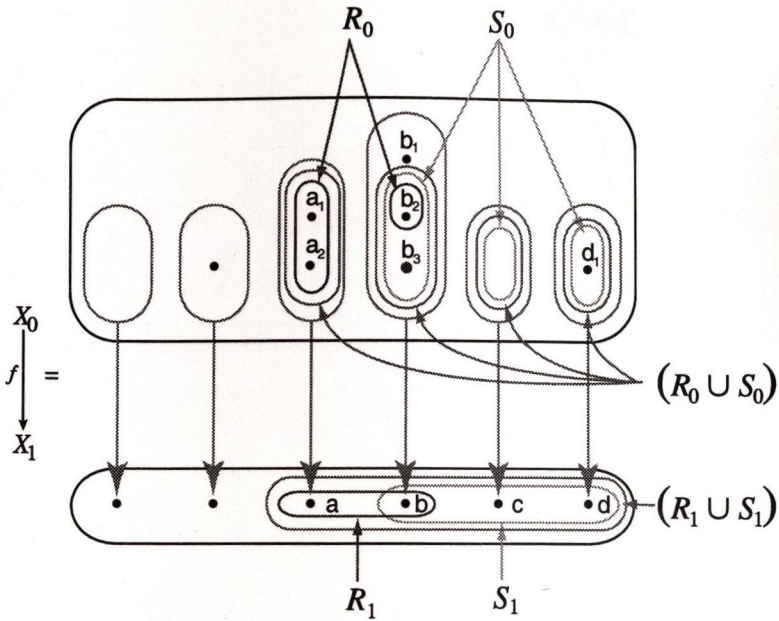

The object  $f|_{R_1}^{R_0} \vee f|_{S_1}^{S_0}$  is defined to be the object  $f|_{(R_1 \cup S_1)}^{(R_0 \cup S_0)}$ . The object  $f|_{(R_1 \cup S_1)}^{(R_0 \cup S_0)}$  is a subobject of the object  $f$ . Thus the object  $f|_{R_1}^{R_0} \vee f|_{S_1}^{S_0}$  is a subobject of the object  $f$ . Additionally, the objects  $f|_{R_1}^{R_0}$  and  $f|_{S_1}^{S_0}$  are subobjects of the object  $f|_{R_1 \cup S_1}^{R_0 \cup S_0}$ .

Hence, the union of the subobject  $f|_{R_1}^{R_0} \hookrightarrow f$  with the subobject  $f|_{S_1}^{S_0} \hookrightarrow f$  is defined by

$$(f|_{R_1}^{R_0} \hookrightarrow f) \vee (f|_{S_1}^{S_0} \hookrightarrow f) = (f|_{R_1 \cup S_1}^{R_0 \cup S_0}) \hookrightarrow f. \quad (3.59)$$

What subobject of the object  $f|_{R_1 \cup S_1}^{R_0 \cup S_0}$  does the *negation* of the subobject  $f|_{R_1}^{R_0} \hookrightarrow f|_{R_1 \cup S_1}^{R_0 \cup S_0}$  with respect to the object  $f|_{R_1 \cup S_1}^{R_0 \cup S_0}$  identify?

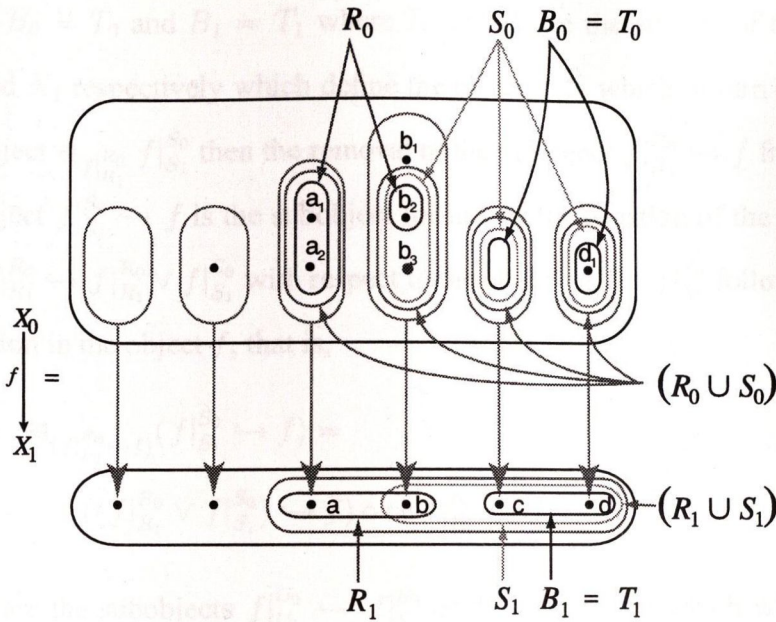

The object  $\neg f|_{R_1}^{R_0}$  wrt  $(f|_{R_1}^{R_0} \vee f|_{S_1}^{S_0})$  is defined to be the object  $f|_{B_1}^{B_0}$  where  $B_0$  is the subset of the set  $R_0 \cup S_0$  which contains only those elements  $x$  of the set  $R_0 \cup S_0$  which are not mapped by  $f$  into the set  $R_1$  and where  $B_1$  is the subset of the set  $R_1 \cup S_1$  which contains only those elements  $y$  of the set  $R_1 \cup S_1$  which are not contained in the set  $R_1$ , that is,

$$B_0 = \{x \in (R_0 \cup S_0) | fx \notin R_1\} \quad \text{and} \quad B_1 = \triangleleft_{R_1} S_1. \quad (3.60)$$

The object  $f|_{B_1}^{B_0}$  is a subobject of the object  $f|_{R_1}^{R_0} \vee f|_{S_1}^{S_0}$ . Thus the object  $\neg f|_{R_1}^{R_0}$  wrt  $(f|_{R_1}^{R_0} \vee f|_{S_1}^{S_0})$  is a subobject of the object  $f|_{R_1}^{R_0} \vee f|_{S_1}^{S_0}$ .

Hence, the negation of the subobject  $f|_{R_1}^{R_0} \hookrightarrow f|_{R_1}^{R_0} \vee f|_{S_1}^{S_0}$  with respect to the object  $f|_{R_1}^{R_0} \vee f|_{S_1}^{S_0}$  is defined by

$$\begin{aligned} \neg(f|_{R_1}^{R_0} \hookrightarrow f|_{R_1}^{R_0} \vee f|_{S_1}^{S_0}) = \\ (\neg f|_{R_1}^{R_0} \text{ wrt } (f|_{R_1}^{R_0} \vee f|_{S_1}^{S_0})) \hookrightarrow f|_{R_1}^{R_0} \vee f|_{S_1}^{S_0}. \end{aligned} \quad (3.61)$$



Since  $B_0 = T_0$  and  $B_1 = T_1$  where  $T_0$  and  $T_1$  are the subsets of the sets  $X_0$  and  $X_1$  respectively which define the object  $f|_{T_1}^{T_0}$  which in turn defines the object  $\triangleleft_{f|_{R_1}^{R_0}} f|_{S_1}^{S_0}$  then the removal of the subobject  $f|_{R_1}^{R_0} \hookrightarrow f$  from the subobject  $f|_{S_1}^{S_0} \hookrightarrow f$  is the subobject formed by the negation of the subobject  $f|_{R_1}^{R_0} \hookrightarrow f|_{R_1}^{R_0} \vee f|_{S_1}^{S_0}$  with respect to the object  $f|_{R_1}^{R_0} \vee f|_{S_1}^{S_0}$  followed by inclusion in the object  $f$ , that is,

$$\begin{aligned} \triangleleft_{(f|_{R_1}^{R_0} \hookrightarrow f)} (f|_{S_1}^{S_0} \hookrightarrow f) = \\ ((f|_{R_1}^{R_0} \vee f|_{S_1}^{S_0}) \hookrightarrow f) \circ \neg (f|_{R_1}^{R_0} \hookrightarrow f|_{R_1}^{R_0} \vee f|_{S_1}^{S_0}). \end{aligned} \tag{3.62}$$

(iii) What are the subobjects  $f|_{U_1}^{U_0} \hookrightarrow f|_{S_1}^{S_0}$  of the object  $f|_{S_1}^{S_0}$  which when included in the object  $f|_{R_1}^{R_0} \vee f|_{S_1}^{S_0}$  are disjoint from the subobject  $f|_{R_1}^{R_0} \hookrightarrow f|_{R_1}^{R_0} \vee f|_{S_1}^{S_0}$ ? One might now wish to consider the Heyting algebra of parts of the object  $f|_{R_1}^{R_0} \vee f|_{S_1}^{S_0}$ , in the same way that we did for the topos of endomaps  $\mathcal{S}^{\circlearrowright}$  in section 3.5?

Unfortunately, the presence of null sets in fibers leads to a sort of exponential expansion of the *Heyting algebra* lattice diagram of the subobjects of  $f|_{R_1}^{R_0} \vee f|_{S_1}^{S_0}$ .

Fortunately, the algebraic reasoning of the same question for the topos of endomaps  $\mathcal{S}^{\circlearrowright}$  in section 3.5 applies in this case also, allowing for appropriate substitution of endomaps by fiber structures.

Hence, the domain of definition of the  $\mathcal{S}^\downarrow$ -partial map  $f \overset{\alpha \uparrow \beta}{\rightsquigarrow} g$  is the subobject

$$(\triangleleft_{f|_{R_1}^{R_0}} f|_{S_1}^{S_0} \vee f|_{S_1}^{S_0}) \hookrightarrow f \text{ of the object } f:$$

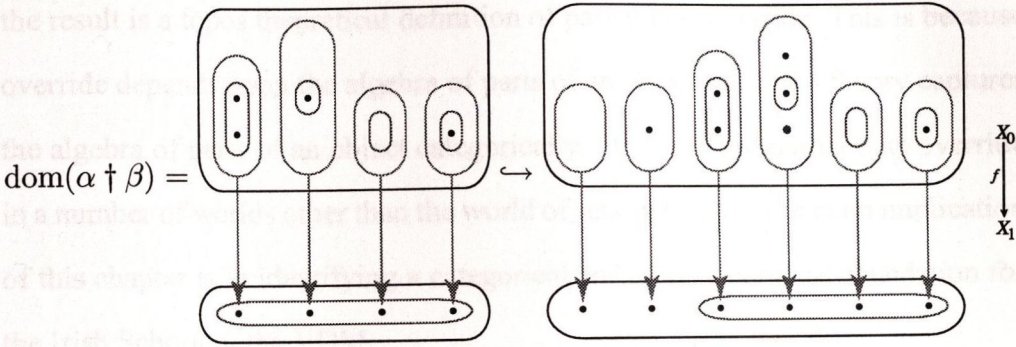

and on this subobject the partial map is defined by the following  $\mathcal{S}^\downarrow$ -map

$$(\triangleleft_{f|_{R_1}^{R_0}} f|_{S_1}^{S_0} \vee f|_{S_1}^{S_0}) \overset{\alpha \uparrow \beta}{\rightarrow} g:$$

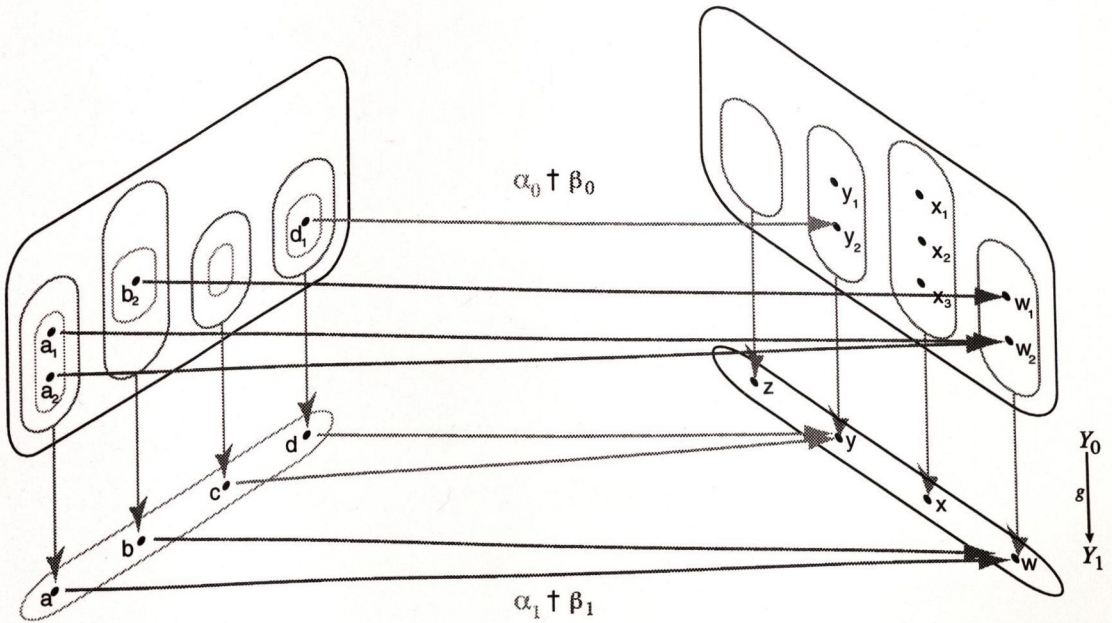



### 3.7 Summary

This chapter set out to give a categorical definition of partial map override and the result is a topos theoretical definition of partial map override. This is because override depends upon the algebra of parts of an object and topos theory captures the algebra of parts of an object categorically. One explored partial map override in a number of worlds other than the world of sets and maps. The main implication of this chapter is in identifying a categorical and topos theoretical foundation for the Irish School of the VDM.

### Reconsidered

The purpose of this chapter is to provide a categorical definition of partial map override. The algebraic foundation for partial map override is the theory of partial map override in the Irish School of the VDM.

(i)  $\text{map} : \text{map} \rightarrow \text{map}$

(ii)  $\text{map} : \text{map} \rightarrow \text{map}$

These algebraic operations define the algebra of parts of an object in the VDM from which we build models of systems.

These formalisms are motivated due to the categorical foundation of the VDM. The defined algebraic operations are

(i)  $\text{map} : \text{map} \rightarrow \text{map}$

(ii)  $\text{map} : \text{map} \rightarrow \text{map}$

## Chapter 4

# Algebraic Foundations

## Reconsidered

The purpose of this chapter is to develop a coherent foundation for partial map operators. The algebraic foundations for partial map operators introduced by Mac an Airchinnigh (1990) are:

- (i) monoids, and
- (ii) monoid morphisms — including endomorphisms and admissible morphisms.

These algebraic foundations underpin the operators in the Irish School of the VDM from which one builds models of systems.

These foundations may be refined due to the existence of a number of foundational opportunities. The refined algebraic foundations are:

- (i) inner laws and inner law morphisms, and
- (ii) outer laws and outer law morphisms.



The refined algebraic foundations are generalizations of the original foundations.

The refined algebraic foundations are presented and the partial map operators are classified using the refined foundations [see appendix A for a summary of partial map operators]. By proving basic identities one demonstrates the advantages of the refined foundations. In addition one also identifies the boundary between the algebraic and categorical foundations.

## 4.1 Algebraic Foundations Reconsidered

“We have now clearly separated the VDM operators into well-defined classes. Operators such as set intersection [...] and [partial] map override are essentially construction operators which give us corresponding monoids. Then there are the classes of the dual monoid endomorphisms: the removal and restriction operators. Many of the other operators are homomorphisms of one sort or another. Among those which are not homomorphisms, I note the [...] range operator of [partial] maps.” (Mac an Airchinnigh 1990, page 127)

Thus, the algebraic foundations for partial map operators in Mac an Airchinnigh (1990, 91–130) are: (i) *monoids* and (ii) *monoid morphisms* — including *endomorphisms* and *admissible morphisms*.

This algebraic framework for partial map operators may be *refined* because of the following foundational opportunities:

- (i) There are a number of ‘old’ and ‘new’ partial map operators which are not yet classified. For example: partial map extension  $\sqcup$ , partial map glueing  $\cup$ ,

and partial map intersection  $\cap$ .

- (ii) There are a number of ‘old’ and ‘new’ partial map identities which are not yet classified. For example:

$$\text{rng}(\mu \sqcup \nu) = \text{rng} \mu \cup \text{rng} \nu$$

$$\triangleleft_S(\mu \sqcup \nu) = \triangleleft_S \mu \sqcup \triangleleft_S \nu$$

$$(\triangleleft_S \alpha) \cdot \mu = \triangleleft_{\mu^{-1}S}(\alpha \cdot \mu)$$

$$\triangleleft_{(\triangleleft_R S)} \mu = \triangleleft_S \mu \cup \triangleleft_R \mu$$

- (iii) How does the range partial map operator interact with other operators? For example:

$$\text{rng}(\triangleleft_S \mu) = \triangleleft_{(\forall_\mu S)} \text{rng}(\mu)$$

$$\text{rng}(\triangleleft_S \mu) = \triangleleft_{(\exists_\mu S)} \text{rng}(\mu)$$

The notations  $\forall_\mu S$  and  $\exists_\mu S$  are taken from Mac Lane and Moerdijk (1992, 58).

- (iv) Why is the range partial map operator not a monoid morphism? For example:

$$\text{rng}(\mu \dagger \nu) \subseteq \text{rng}(\mu) \cup \text{rng}(\nu).$$

Can one strengthen identity to equality?

- (v) There are a number of ‘old’ and ‘new’ monoid morphisms which remain unproven. For example:

$$(\text{phom}(X, Y), \dagger, \theta) \xrightarrow{\text{dom}} (\mathcal{P}X, \cup, \emptyset)$$

$$(\text{phom}(Y, Z), \dagger, \theta) \xrightarrow{-\mu} (\text{phom}(X, Z), \dagger, \theta)$$



### 4.1.1 Inner Laws

An *inner law*  $*$  in a set  $S$ , denoted  $(S, *)$ , is a partial mapping from the product set  $S \times S$  to the set  $S$ ,

$$S \times S \rightsquigarrow S: (s_1, s_2) \mapsto s_1 * s_2. \quad (4.1)$$

Here is a list of examples of inner laws:

- (i)  $(\text{phom}(X, Y), \sqcup)$ , the extension of partial maps in the set of partial maps between two sets.
- (ii)  $(\text{phom}(X, Y), \cup)$ , the glueing of partial maps in the set of partial maps between two sets.

An inner law  $*$  is *everywhere defined* in a set  $E$ , if the associated partial mapping is a mapping from the product set  $E \times E$  to the set  $E$ ,

$$E \times E \xrightarrow{*} E: (e_1, e_2) \mapsto e_1 * e_2. \quad (4.2)$$

Below is a list of examples of everywhere defined inner laws:

- (i)  $(\mathbb{N}, +)$ , the addition of natural numbers in the set of natural numbers  $\mathbb{N}$ .
- (ii)  $(\mathbb{N}', \times)$ , the multiplication of natural numbers in the set of non-zero natural numbers  $\mathbb{N}'$ .
- (iii)  $(\mathcal{P}X, \cup)$ , the union of subsets in the set  $\mathcal{P}X$  of subsets of the set  $X$ .
- (iv)  $(\mathcal{P}X, \cap)$ , the intersection of subsets in the set  $\mathcal{P}X$  of subsets of the set  $X$ .
- (v)  $(\text{phom}(X, Y), \cap)$ , the intersection of partial maps in the set of partial maps between two sets.

(vi)  $(\text{phom}(X, Y), \dagger)$ , the overriding of partial maps in the set of partial maps between two sets.

An inner law  $*$  in the set  $S$  is *associative* if either  $s_1 * (s_2 * s_3)$  or  $(s_1 * s_2) * s_3$  is defined for  $s_1, s_2, s_3 \in S$ , then they are both defined and

$$s_1 * (s_2 * s_3) = (s_1 * s_2) * s_3. \quad (4.3)$$

All of the above inner laws are associative.

An inner law  $*$  in the set  $S$  is *commutative* if either  $s_1 * s_2$  or  $s_2 * s_1$  is defined for  $s_1, s_2 \in S$ , then they are both defined and

$$s_1 * s_2 = s_2 * s_1. \quad (4.4)$$

With the exception of partial map override the above inner laws are commutative. One might ask under what conditions will partial map override be commutative?

Let  $X \xrightarrow{\mu} Y$  and  $X \xrightarrow{\nu} Y$  be two partial maps and consider the following argument:

$$\begin{aligned} & \mu \dagger \nu \\ = & \quad \{\text{override in terms of removal and extension}\} \\ & \triangleleft_{\text{dom } \nu} \mu \sqcup \nu \\ = & \quad \{\text{extension is commutative}\} \end{aligned}$$

With the exception of partial map intersection the above inner laws have identity elements. Define each of these identity elements



$$\begin{aligned}
& \triangleleft_{\text{dom } \nu} \mu \sqcup \nu \\
= & \quad \{\text{extension is commutative}\} \\
& \nu \sqcup \triangleleft_{\text{dom } \nu} \mu \\
= & \quad \{\text{partition of } \nu \text{ by the set } \text{dom } \mu\} \\
& \triangleleft_{\text{dom } \mu} \nu \sqcup \triangleleft_{\text{dom } \mu} \nu \sqcup \triangleleft_{\text{dom } \nu} \mu \\
= & \quad \{\text{assuming } \triangleleft_{\text{dom } \mu} \nu = \triangleleft_{\text{dom } \nu} \mu\} \\
& \triangleleft_{\text{dom } \mu} \nu \sqcup \triangleleft_{\text{dom } \nu} \mu \sqcup \triangleleft_{\text{dom } \nu} \mu \\
= & \quad \{\text{partition of } \mu \text{ by the set } \text{dom } \nu\} \\
& \triangleleft_{\text{dom } \mu} \nu \sqcup \mu \\
= & \quad \{\text{override in terms of removal and extension}\} \\
& \nu \dagger \mu
\end{aligned}$$

Hence, we have found a necessary as well as sufficient condition under which partial map override will be commutative

$$\triangleleft_{\text{dom } \mu} \nu = \triangleleft_{\text{dom } \nu} \mu \quad \Rightarrow \quad \mu \dagger \nu = \nu \dagger \mu. \quad (4.5)$$

We have already met the above condition as the condition under which two partial maps may be glued together.

An inner law  $*$  in the set  $S$  has an *identity element*  $u$  if there exists  $u \in S$  such that for all  $s \in S$

$$s * u = s = u * s. \quad (4.6)$$

With the exception of partial map intersection the above inner laws have identity elements. Below is a list of these identity elements:

- (i)  $\theta$ , the empty map for the inner law  $(\text{phom}(X, Y), \sqcup)$ .
- (ii)  $\theta$ , the empty map for the inner law  $(\text{phom}(X, Y), \cup)$ .
- (iii)  $0$ , the natural number zero for the inner law  $(\mathbb{N}, +)$ .
- (iv)  $1$ , the natural number one for the inner law  $(\mathbb{N}', \times)$ .
- (v)  $\emptyset$ , the empty set for the inner law  $(\mathcal{P}X, \cup)$ .
- (vi)  $X$ , the set  $X$  for the inner law  $(\mathcal{P}X, \cap)$ .
- (vii)  $\theta$ , the empty map for the inner law  $(\text{phom}(X, Y), \dagger)$ .

An inner law  $*$  in the set  $S$  is *idempotent* if for all  $s \in S$ ,

$$s * s = s. \quad (4.7)$$

With the exceptions of partial map extension, natural number addition and natural number multiplication the above inner laws are idempotent.

### 4.1.2 Inner Law Morphisms

An *inner law morphism*  $m$  from the inner law  $(R, \star)$  to the inner law  $(S, *)$ , denoted  $(R, \star) \xrightarrow{m} (S, *)$ , is a map  $R \xrightarrow{m} S$  which preserves the inner law structure, that is, if  $r_1 \star r_2$  and  $m(r_1) * m(r_2)$  are defined for  $r_1, r_2 \in R$ , then

$$m(r_1 \star r_2) = m(r_1) * m(r_2). \quad (4.8)$$

Here is a list of examples of inner law morphisms:



- (i)  $(\text{phom}(X, Y), \sqcup) \xrightarrow{\text{dom}} (\mathcal{P}X, \cup)$ , the domain operator is an inner law morphism from the inner law of partial map extension in the set of partial maps between two sets to the inner law of subset union in the set of subsets of the set  $X$ .

Thus, if  $X \overset{\mu}{\rightsquigarrow} Y$  and  $X \overset{\nu}{\rightsquigarrow} Y$  are extendable partial maps, then

$$\text{dom}(\mu \sqcup \nu) = \text{dom } \mu \cup \text{dom } \nu. \tag{4.9}$$

- (ii)  $(\text{phom}(X, Y), \cup) \xrightarrow{\text{dom}} (\mathcal{P}X, \cup)$ , the domain operator is an inner law morphism from the inner law of partial map glueing in the set of partial maps between two sets to the inner law of subset union in the set of subsets of the set  $X$ .

Thus, if  $X \overset{\mu}{\rightsquigarrow} Y$  and  $X \overset{\nu}{\rightsquigarrow} Y$  are glueable partial maps, then

$$\text{dom}(\mu \cup \nu) = \text{dom } \mu \cup \text{dom } \nu. \tag{4.10}$$

- (iii)  $(\text{phom}(X, Y), \sqcup) \xrightarrow{\text{rng}} (\mathcal{P}Y, \cup)$ , the range operator is an inner law morphism from the inner law of partial map extension in the set of partial maps between two sets to the inner law of subset union in the set of subsets of the set  $Y$ .

Thus, if  $X \overset{\mu}{\rightsquigarrow} Y$  and  $X \overset{\nu}{\rightsquigarrow} Y$  are extendable partial maps, then

$$\text{rng}(\mu \sqcup \nu) = \text{rng } \mu \cup \text{rng } \nu. \tag{4.11}$$

- (iv) We might now ask if the range operator is an inner law morphism from the inner law  $(\text{phom}(X, Y), \cup)$  to the inner law  $(\mathcal{P}Y, \cup)$ ?

Let  $X \overset{\mu}{\rightsquigarrow} Y$  and  $X \overset{\nu}{\rightsquigarrow} Y$  be glueable partial maps and consider the following argument:

$$\begin{aligned}
 & \text{rng}(\mu \cup \nu) \\
 = & \quad \{\text{glueing in terms of removal, restriction and extension}\} \\
 & \text{rng}(\triangleleft_{\text{dom } \nu} \mu \sqcup \triangleleft_{\text{dom } \nu} \mu \sqcup \triangleleft_{\text{dom } \mu} \nu) \\
 = & \quad \{\text{rng is an inner law morphism}\} \\
 & \text{rng } \triangleleft_{\text{dom } \nu} \mu \cup \text{rng } \triangleleft_{\text{dom } \nu} \mu \cup \text{rng } \triangleleft_{\text{dom } \mu} \nu \\
 = & \quad \{\text{glueing condition implies } \text{rng } \triangleleft_{\text{dom } \nu} \mu = \text{rng } \triangleleft_{\text{dom } \mu} \nu\} \\
 & \text{rng } \triangleleft_{\text{dom } \nu} \mu \cup \text{rng } \triangleleft_{\text{dom } \nu} \mu \cup \text{rng } \triangleleft_{\text{dom } \mu} \nu \cup \text{rng } \triangleleft_{\text{dom } \mu} \nu \\
 = & \quad \{\text{rng is an inner law morphism}\} \\
 & \text{rng}(\triangleleft_{\text{dom } \nu} \mu \sqcup \triangleleft_{\text{dom } \nu} \mu) \cup \text{rng}(\triangleleft_{\text{dom } \mu} \nu \sqcup \triangleleft_{\text{dom } \mu} \nu) \\
 = & \quad \{\text{partition of } \mu \text{ and } \nu \text{ by the sets } \text{dom } \nu \text{ and } \text{dom } \mu\} \\
 & \text{rng } \mu \cup \text{rng } \nu
 \end{aligned}$$

Hence, we have shown that the range operator preserves the inner law structure

$$\text{rng}(\mu \cup \nu) = \text{rng } \mu \cup \text{rng } \nu. \quad (4.12)$$

Thus, the range operator is an inner law morphism from the inner law of partial map glueing in the set of partial maps between two sets to the inner law of subset union in the set of subsets of the set  $Y$ ,

$$(\text{phom}(X, Y), \cup) \xrightarrow{\text{rng}} (\mathcal{P}Y, \cup).$$

- (v) We might ask if the operator  $\exists_S$  for the subset  $S$  of the set  $X$  is an inner law morphism from the inner law  $(\text{phom}(X, Y), \sqcup)$  to the inner law  $(\mathcal{P}Y, \cup)$ ?



Let  $X \xrightarrow{\mu} Y$  and  $X \xrightarrow{\nu} Y$  be extendable partial maps and consider the following argument:

$$\begin{aligned}
 & \exists_{\mu \sqcup \nu} S \\
 = & \quad \{\text{existential image in terms of restriction and range}\} \\
 & \text{rng } \triangleleft_S (\mu \sqcup \nu) \\
 = & \quad \{\triangleleft_S \text{ is an inner law endomorphism}\} \\
 & \text{rng}(\triangleleft_S \mu \sqcup \triangleleft_S \nu) \\
 = & \quad \{\text{rng is an inner law morphism}\} \\
 & \text{rng } \triangleleft_S \mu \cup \text{rng } \triangleleft_S \nu \\
 = & \quad \{\text{existential image in terms of restriction and range}\} \\
 & \exists_{\mu} S \cup \exists_{\nu} S
 \end{aligned}$$

Hence, we have shown that the operator  $\exists_S$  preserves the inner law structure

$$\exists_{\mu \sqcup \nu} S = \exists_{\mu} S \cup \exists_{\nu} S. \tag{4.13}$$

Thus, the operator  $\exists_S$  is an inner law morphism from the inner law of partial map extension in the set of partial maps between two sets to the inner law of subset union in the set of subset of the set  $Y$ ,

$$(\text{phom}(X, Y), \sqcup) \xrightarrow{\exists_S} (\mathcal{P}Y, \cup).$$

(vi)  $(\text{phom}(X, Y), \sqcup) \xrightarrow{-^1 S} (\mathcal{P}X, \cup)$ , the operator  $-^1 S$  for the subset  $S$  of the set  $Y$  is an inner law morphism from the inner law of partial map extension in the set of partial maps between two sets to the inner law of subset union in the set of subsets of the set  $X$ .

Thus, if  $X \xrightarrow{\mu} Y$  and  $X \xrightarrow{\nu} Y$  are extendable partial maps, then

$$(\mu \sqcup \nu)^{-1}S = \mu^{-1}S \cup \nu^{-1}S. \tag{4.14}$$

- (vii) We might ask if the operator  $\alpha \cdot -$  for the partial map  $Y \xrightarrow{\alpha} Z$  is an inner law morphism from the inner law  $(\text{phom}(X, Y), \sqcup)$  to the inner law  $(\text{phom}(X, Z), \sqcup)$ ?

Let  $X \xrightarrow{\mu} Y$  and  $X \xrightarrow{\nu} Y$  be extendable partial maps and consider the following argument:

$$\begin{aligned} & \alpha \cdot (\mu \sqcup \nu) \\ = & \quad \{\text{definition of partial map composition}\} \\ & \alpha \circ (\mu \sqcup \nu)|_{\text{dom } \alpha} \\ = & \quad \{\text{partial map extension in terms of sum}\} \\ & \alpha \circ [\mu, \nu] |_{\text{dom } \alpha} \\ = & \quad \{\text{pullback preserves sums}\} \\ & \alpha \circ [\mu|_{\text{dom } \alpha}, \nu|_{\text{dom } \alpha}] \\ = & \quad \{\text{sum fusion law}\} \\ & [\alpha \circ \mu|_{\text{dom } \alpha}, \alpha \circ \nu|_{\text{dom } \alpha}] \\ = & \quad \{\text{partial map extension in terms of sum}\} \\ & \alpha \circ \mu|_{\text{dom } \alpha} \sqcup \alpha \circ \nu|_{\text{dom } \alpha} \\ = & \quad \{\text{definition of partial map composition}\} \\ & \alpha \cdot \mu \sqcup \alpha \cdot \nu \end{aligned}$$

Hence, we have shown that the operator  $\alpha \cdot -$  preserves the inner law structure

$$\alpha \cdot (\mu \sqcup \nu) = \alpha \cdot \mu \sqcup \alpha \cdot \nu. \tag{4.15}$$



Thus, the operator  $\alpha \cdot \_$  is an inner law morphism from the inner law of partial map extension in a set of partial maps between two sets to another inner law of partial map extension in a set of partial maps between two sets,

$$(\text{phom}(X, Y), \sqcup) \xrightarrow{\alpha \cdot} (\text{phom}(X, Z), \sqcup).$$

(viii) We might also ask if the operator  $\_ \cdot \mu$  for the partial map  $X \xrightarrow{\mu} Y$  is an inner law morphism from the inner law  $(\text{phom}(Y, Z), \sqcup)$  to the inner law  $(\text{phom}(X, Z), \sqcup)$ ?

In the following argument the maps  $\text{inl}$  and  $\text{inr}$  denote the injective maps associated with the sum set  $\text{dom } \alpha + \text{dom } \beta$ ,

$$\text{dom } \alpha \xrightarrow{\text{inl}} \text{dom } \alpha + \text{dom } \beta \xleftarrow{\text{inr}} \text{dom } \beta.$$

Let  $Y \xrightarrow{\alpha} Z$  and  $Y \xrightarrow{\beta} Z$  be extendable partial maps and consider the following argument:

$$\begin{aligned} & (\alpha \sqcup \beta) \cdot \mu \\ = & \quad \{\text{definition of partial map composition}\} \\ & (\alpha \sqcup \beta) \circ \mu|_{\text{dom}(\alpha \sqcup \beta)} \\ = & \quad \{\text{dom is an inner law morphism}\} \\ & (\alpha \sqcup \beta) \circ \mu|_{\text{dom } \alpha \cup \text{dom } \beta} \\ = & \quad \{\text{partial map extension in terms of sum,} \\ & \quad \text{dom } \alpha \cap \text{dom } \beta = \emptyset\} \\ & [\alpha, \beta] \circ \mu|_{\text{dom } \alpha + \text{dom } \beta} \end{aligned}$$

$$\begin{aligned}
 &= \{ \text{partial map extension in terms of sum,} \\
 &\quad \text{dom } \alpha \cap \text{dom } \beta = \emptyset \} \\
 &\quad [\alpha, \beta] \circ \mu|_{\text{dom } \alpha + \text{dom } \beta} \\
 &= \{ \text{pullback preserves sums} \} \\
 &\quad [\alpha, \beta] \circ [\text{inl} \circ \mu|_{\text{dom } \alpha}, \text{inr} \circ \mu|_{\text{dom } \beta}] \\
 &= \{ \text{sum fusion law} \} \\
 &\quad [[\alpha, \beta] \circ \text{inl} \circ \mu|_{\text{dom } \alpha}, [\alpha, \beta] \circ \text{inr} \circ \mu|_{\text{dom } \beta}] \\
 &= \{ \text{sum cancellation properties} \} \\
 &\quad [\alpha \circ \mu|_{\text{dom } \alpha}, \beta \circ \mu|_{\text{dom } \beta}] \\
 &= \{ \text{partial map extension in terms of sum} \} \\
 &\quad (\alpha \circ \mu|_{\text{dom } \alpha}) \sqcup (\beta \circ \mu|_{\text{dom } \beta}) \\
 &= \{ \text{definition of partial map composition} \} \\
 &\quad \alpha \cdot \mu \sqcup \beta \cdot \mu
 \end{aligned}$$

Hence, we have shown that the operator  $\_ \cdot \mu$  preserves the inner law structure

$$(\alpha \sqcup \beta) \cdot \mu = \alpha \cdot \mu \sqcup \beta \cdot \mu. \tag{4.16}$$

Thus, the operator  $\_ \cdot \mu$  is an inner law morphism from the inner law of partial map extension in a set of partial maps between two sets to another inner law of partial map extension in a set of partial maps between two sets,

$$(\text{phom}(Y, Z), \sqcup) \xrightarrow{\_ \cdot \mu} (\text{phom}(X, Z), \sqcup).$$

- (ix) We might ask if the operator  $\text{phom}(f, g)$  for the ‘map’  $X_1 \xrightarrow{f} X_2$  and the map  $Y_1 \xrightarrow{g} Y_2$  is an inner law morphism from the inner law  $(\text{phom}(X_1, Y_1), \sqcup)$  to the inner law  $(\text{phom}(X_2, Y_2), \sqcup)$ ?



Let  $X_1 \xrightarrow{\mu} Y_1$  and  $X_1 \xrightarrow{\nu} Y_1$  be extendable partial maps and consider the following argument:

$$\begin{aligned}
 & \text{phom}(f, g)(\mu \sqcup \nu) \\
 = & \{ \text{definition of } \text{phom}(f, g) \} \\
 & g \circ (\mu \sqcup \nu) \circ f|_{\text{dom}(\mu \sqcup \nu)} \\
 = & \{ \text{partial map composition covers map composition,} \\
 & \text{definition of partial map composition} \} \\
 & g \cdot ((\mu \sqcup \nu) \cdot f) \\
 = & \{ \_ \cdot f \text{ is an inner law morphism} \} \\
 & g \cdot (\mu \cdot f \sqcup \nu \cdot f) \\
 = & \{ g \cdot \_ \text{ is an inner law morphism} \} \\
 & g \cdot \mu \cdot f \sqcup g \cdot \nu \cdot f \\
 = & \{ \text{cod}(\mu \cdot f) = \text{cod}(g \cdot \nu) = Y = \text{dom}(g), \\
 & \text{definition of partial map composition} \} \\
 & g \circ \mu \circ f|_{\text{dom} \mu} \sqcup g \circ \nu \circ f|_{\text{dom} \nu} \\
 = & \{ \text{definition of } \text{phom}(f, g) \} \\
 & \text{phom}(f, g)\mu \sqcup \text{phom}(f, g)\nu
 \end{aligned}$$

Hence, we have shown that the operator  $\text{phom}(f, g)$  preserves the inner law structure

$$\text{phom}(f, g)(\mu \sqcup \nu) = \text{phom}(f, g)\mu \sqcup \text{phom}(f, g)\nu. \tag{4.17}$$

Thus, the operator  $\text{phom}(f, g)$  is an inner law morphism from the inner law of partial map extension in a set of partial maps between two sets to another

(iv) inner law of partial map extension in a set of partial maps between two sets,

$$(\text{phom}(X_1, Y_1), \sqcup) \xrightarrow{\text{phom}(f,g)} (\text{phom}(X_2, Y_2), \sqcup).$$

### 4.1.3 Inner Law Endomorphisms

An inner law endomorphism  $e$  of the inner law  $(S, *)$ , denoted  $(S, *)^{\circlearrowleft e}$ , is a map  $S \xrightarrow{e} S$  which preserves the inner law structure, that is, if  $s_1 * s_2$  and  $e(s_1) * e(s_2)$  are defined for  $s_1, s_2 \in S$ , then

$$e(s_1 * s_2) = e(s_1) * e(s_2). \tag{4.18}$$

Here is a list of examples of inner law endomorphisms:

- (i)  $(\mathcal{P}X, \cup)^{\circlearrowleft S}$ , the removal of a subset  $S$  of the set  $X$  is an inner law endomorphism of the inner law of subset union in the set of subsets of the set  $X$ .
- (ii)  $(\mathcal{P}X, \cup)^{\circlearrowleft S}$ , the restriction to a subset  $S$  of the set  $X$  is an inner law endomorphism of the inner law of subset union in the set of subsets of the set  $X$ .
- (iii)  $(\text{phom}(X, Y), \sqcup)^{\circlearrowleft S}$ , the removal of a subset  $S$  of the set  $X$  is an inner law endomorphism of the inner law of partial map extension in the set of partial maps between two sets.

Thus, if  $X \overset{\mu}{\rightsquigarrow} Y$  and  $X \overset{\nu}{\rightsquigarrow} Y$  are extendable partial maps, then

$$\triangleleft_S(\mu \sqcup \nu) = \triangleleft_S \mu \sqcup \triangleleft_S \nu. \tag{4.19}$$



(iv)  $(\text{phom}(X, Y), \sqcup)^{\circlearrowleft_S}$ , the restriction to a subset  $S$  of the set  $X$  is an inner law endomorphism of the inner law of partial map extension in the set of partial maps between two sets.

Thus, if  $X \overset{\mu}{\rightsquigarrow} Y$  and  $X \overset{\nu}{\rightsquigarrow} Y$  are extendable partial maps, then

$$\triangleleft_S(\mu \sqcup \nu) = \triangleleft_S \mu \sqcup \triangleleft_S \nu. \tag{4.20}$$

(v) We could ask if the removal of a subset  $S$  of the set  $X$  is an inner law endomorphism of the inner law  $(\text{phom}(X, Y), \cup)$ ?

Let  $X \overset{\mu}{\rightsquigarrow} Y$  and  $X \overset{\nu}{\rightsquigarrow} Y$  be glueable partial maps and consider the following argument:

$$\begin{aligned} & \triangleleft_S(\mu \cup \nu) \\ = & \quad \{\text{glueing in terms of removal, restriction and extension}\} \\ & \triangleleft_S(\triangleleft_{\text{dom } \nu} \mu \sqcup \triangleleft_{\text{dom } \nu} \mu \sqcup \triangleleft_{\text{dom } \mu} \nu) \\ = & \quad \{\triangleleft_S \text{ is an inner law endomorphism}\} \\ & \triangleleft_S \triangleleft_{\text{dom } \nu} \mu \sqcup \triangleleft_S \triangleleft_{\text{dom } \nu} \mu \sqcup \triangleleft_S \triangleleft_{\text{dom } \mu} \nu \\ = & \quad \{\text{glueing condition implies } \triangleleft_S \triangleleft_{\text{dom } \nu} \mu = \triangleleft_S \triangleleft_{\text{dom } \mu} \nu\} \\ & \triangleleft_S \triangleleft_{\text{dom } \nu} \mu \sqcup (\triangleleft_S \triangleleft_{\text{dom } \nu} \mu \cup \triangleleft_S \triangleleft_{\text{dom } \mu} \nu) \sqcup \triangleleft_S \triangleleft_{\text{dom } \mu} \nu \end{aligned}$$

(4.22)

$$\begin{aligned}
 &= \{ \text{glueing condition implies } \triangleleft_S \triangleleft_{\text{dom } \nu} \mu = \triangleleft_S \triangleleft_{\text{dom } \mu} \nu \} \\
 &\quad \triangleleft_S \triangleleft_{\text{dom } \nu} \mu \sqcup (\triangleleft_S \triangleleft_{\text{dom } \nu} \mu \cup \triangleleft_S \triangleleft_{\text{dom } \mu} \nu) \sqcup \triangleleft_S \triangleleft_{\text{dom } \mu} \nu \\
 &= \{ \} \\
 &\quad (\triangleleft_S \triangleleft_{\text{dom } \nu} \mu \sqcup \triangleleft_S \triangleleft_{\text{dom } \nu} \mu) \cup (\triangleleft_S \triangleleft_{\text{dom } \mu} \nu \sqcup \triangleleft_S \triangleleft_{\text{dom } \mu} \nu) \\
 &= \{ \triangleleft_S \text{ is an inner law endomorphism} \} \\
 &\quad \triangleleft_S (\triangleleft_{\text{dom } \nu} \mu \sqcup \triangleleft_{\text{dom } \nu} \mu) \cup \triangleleft_S (\triangleleft_{\text{dom } \mu} \nu \sqcup \triangleleft_{\text{dom } \mu} \nu) \\
 &= \{ \text{partition of } \mu \text{ and } \nu \text{ by the sets } \text{dom } \nu \text{ and } \text{dom } \mu \} \\
 &\quad \triangleleft_S \mu \cup \triangleleft_S \nu
 \end{aligned}$$

Hence, we have shown that the removal of a subset  $S$  of the set  $X$  preserves the inner law structure

$$\triangleleft_S(\mu \cup \nu) = \triangleleft_S \mu \cup \triangleleft_S \nu. \tag{4.21}$$

Thus, the removal of a subset  $S$  of the set  $X$  is an inner law endomorphism of the inner law of partial map glueing in the set of partial maps between two sets:

$$(\text{phom}(X, Y), \cup)^{\triangleleft_S}.$$

(vi)  $(\text{phom}(X, Y), \cup)^{\triangleleft_S}$ , the restriction to a subset  $S$  of the set  $X$  is an inner law endomorphism of the inner law of partial map glueing in the set of partial maps between two sets.

Thus, if  $X \xrightarrow{\mu} Y$  and  $X \xrightarrow{\nu} Y$  are glueable partial maps, then

$$\triangleleft_S(\mu \cup \nu) = \triangleleft_S \mu \cup \triangleleft_S \nu. \tag{4.22}$$



(vii) We could ask if the range restriction to a subset  $S$  of the set  $Y$  is an inner law endomorphism of the inner law  $(\text{phom}(X, Y), \sqcup)$ ?

Let  $X \xrightarrow{\mu} Y$  and  $X \xrightarrow{\nu} Y$  be extendable partial maps and consider the following argument:

$$\begin{aligned}
 & \triangleright_S(\mu \sqcup \nu) \\
 = & \quad \{\text{definition of range restriction}\} \\
 & \triangleleft_{(\mu \sqcup \nu)^{-1}S}(\mu \sqcup \nu) \\
 = & \quad \{\triangleleft_{(\mu \sqcup \nu)^{-1}S} \text{ is an inner law endomorphism}\} \\
 & \triangleleft_{(\mu \sqcup \nu)^{-1}S} \mu \sqcup \triangleleft_{(\mu \sqcup \nu)^{-1}S} \nu \\
 = & \quad \{-^1S \text{ is an inner law morphism}\} \\
 & \triangleleft_{\mu^{-1}S \cup \nu^{-1}S} \mu \sqcup \triangleleft_{\mu^{-1}S \cup \nu^{-1}S} \nu \\
 = & \quad \{\triangleleft_{\cdot} \mu \text{ and } \triangleleft_{\cdot} \nu \text{ are monoid morphisms}\} \\
 & (\triangleleft_{\mu^{-1}S} \mu \cup \triangleleft_{\nu^{-1}S} \mu) \sqcup (\triangleleft_{\mu^{-1}S} \nu \cup \triangleleft_{\nu^{-1}S} \nu) \\
 = & \quad \{\text{dom } \mu \cap \text{dom } \nu = \emptyset \\
 & \quad \Rightarrow \triangleleft_{\nu^{-1}S} \mu = \theta \wedge \triangleleft_{\mu^{-1}S} \nu = \theta\} \\
 & (\triangleleft_{\mu^{-1}S} \mu \cup \theta) \sqcup (\theta \cup \triangleleft_{\nu^{-1}S} \nu) \\
 = & \quad \{\theta \text{ is an identity element for glueing}\} \\
 & \triangleleft_{\mu^{-1}S} \mu \sqcup \triangleleft_{\nu^{-1}S} \nu \\
 = & \quad \{\text{definition of range restriction}\} \\
 & \triangleright_S \mu \sqcup \triangleright_S \nu
 \end{aligned}$$

Hence, we have shown that the range restriction to a subset  $S$  of the set  $Y$

4.1.4 preserves the inner law structure

$$\triangleright_S(\mu \sqcup \nu) = \triangleright_S \mu \sqcup \triangleright_S \nu. \tag{4.23}$$

Thus, the range restriction to a subset  $S$  of the set  $Y$  is an inner law endomorphism of the inner law of partial map extension in the set of partial maps between two sets,

$$(\text{phom}(X, Y), \sqcup)^{\circlearrowleft \triangleright_S}.$$

(viii)  $(\text{phom}(X, Y), \sqcup)^{\circlearrowleft \triangleright_S}$ , the range removal of a subset  $S$  of the set  $Y$  is an inner law endomorphism of the inner law of partial map extension in the set of partial maps between two sets.

Thus, if  $X \overset{\mu}{\rightsquigarrow} Y$  and  $X \overset{\nu}{\rightsquigarrow} Y$  are extendable partial maps, then

$$\triangleright_S(\mu \sqcup \nu) = \triangleright_S \mu \sqcup \triangleright_S \nu. \tag{4.24}$$

(ix)  $(\text{phom}(X, Y), \cup)^{\circlearrowleft \triangleright_S}$ , the range removal of a subset  $S$  of the set  $Y$  is an inner law endomorphism of the inner law of partial map glueing in the set of partial maps between two sets.

Thus, if  $X \overset{\mu}{\rightsquigarrow} Y$  and  $X \overset{\nu}{\rightsquigarrow} Y$  are glueable partial maps, then

$$\triangleright_S(\mu \cup \nu) = \triangleright_S \mu \cup \triangleright_S \nu. \tag{4.25}$$

(x)  $(\text{phom}(X, Y), \cup)^{\circlearrowleft \triangleright_S}$ , the range restriction to a subset  $S$  of the set  $Y$  is an inner law endomorphism of the inner law of partial map glueing in the set of partial maps between two sets.

Thus, if  $X \overset{\mu}{\rightsquigarrow} Y$  and  $X \overset{\nu}{\rightsquigarrow} Y$  are glueable partial maps, then

$$\triangleright_S(\mu \cup \nu) = \triangleright_S \mu \cup \triangleright_S \nu. \tag{4.26}$$



### 4.1.4 Outer Laws

An outer law  $\Omega$  on the set  $S$ , denoted  $S^{\circlearrowleft \Omega}$ , is a mapping from the product set  $\Omega \times S$  to the set  $S$ ,

$$\Omega \times S \rightarrow S: (\omega, s) \mapsto \omega s. \tag{4.27}$$

The set  $\Omega$  is called a set of operators for  $S$  because each element  $\omega \in \Omega$  induces a mapping from the set  $S$  to the set  $S$  by currying,

$$S \xrightarrow{\omega} S: s \mapsto \omega s.$$

Below is a list of examples of outer laws on sets:

- (i)  $\mathcal{P}X^{\circlearrowleft \triangleleft_{\mathcal{P}X}}$ , the removal of subsets of the set  $X$  is an outer law on the set of subsets of  $X$ .
- (ii)  $\mathcal{P}X^{\circlearrowleft \triangleleft_{\mathcal{P}X}}$ , the restriction to subsets of the set  $X$  is an outer law on the set of subsets of  $X$ .
- (iii)  $\text{phom}(X, Y)^{\circlearrowleft \triangleleft_{\mathcal{P}X}}$ , the removal of subsets of the set  $X$  is an outer law on the set of partial maps between two sets.
- (iv)  $\text{phom}(X, Y)^{\circlearrowleft \triangleleft_{\mathcal{P}X}}$ , the restriction to subsets of the set  $X$  is an outer law on the set of partial maps between two sets.
- (v)  $\text{phom}(X, Y)^{\circlearrowleft \triangleright_{\mathcal{P}Y}}$ , the range removal of subsets of the set  $Y$  is an outer law on the set of partial maps between two sets.
- (vi)  $\text{phom}(X, Y)^{\circlearrowleft \triangleright_{\mathcal{P}Y}}$ , the range restriction to subsets of the set  $Y$  is an outer law on the set of partial maps between two sets.

### 4.1.5 Outer Law Morphisms

An *outer law morphism*  $m$  from the outer law  $R^{\circlearrowleft \Omega}$  to the outer law  $S^{\circlearrowleft \Omega}$ , denoted  $R^{\circlearrowleft \Omega} \xrightarrow{m} S^{\circlearrowleft \Omega}$ , is a map  $R \xrightarrow{m} S$  which preserves the outer law structure, that is, for all  $r \in R$  and for all  $\omega \in \Omega$ ,

$$m(\omega r) = \omega m(r). \tag{4.28}$$

Below is a list of examples of outer law morphisms:

- (i)  $\text{phom}(X, Y)^{\circlearrowleft \triangleleft_{\mathcal{P}X}} \xrightarrow{\text{dom}} \mathcal{P}X^{\circlearrowleft \triangleleft_{\mathcal{P}X}}$ , the domain operator is an outer law morphism from the outer law of subset removal on the set of partial maps between two sets to the outer law of subset removal on the set of subsets of the set  $X$ .

Thus, if  $S$  is a subset of the set  $X$  and  $X \overset{\mu}{\rightsquigarrow} Y$  is a partial map, then

$$\text{dom} \triangleleft_S \mu = \triangleleft_S \text{dom } \mu. \tag{4.29}$$

- (ii)  $\text{phom}(X, Y)^{\circlearrowleft \triangleleft_{\mathcal{P}X}} \xrightarrow{\text{dom}} \mathcal{P}X^{\circlearrowleft \triangleleft_{\mathcal{P}X}}$ , the domain operator is an outer law morphism from the outer law of subset restriction on the set of partial maps between two sets to the outer law of subset restriction on the set of subsets of the set  $X$ .

Thus, if  $S$  is a subset of the set  $X$  and  $X \overset{\mu}{\rightsquigarrow} Y$  is a partial map, then

$$\text{dom} \triangleleft_S \mu = \triangleleft_S \text{dom } \mu. \tag{4.30}$$

- (iii) We could ask if the range operator is an outer law morphism from the outer law  $\text{phom}(X, Y)^{\circlearrowleft \triangleleft_{\mathcal{P}X}}$  to another outer law?



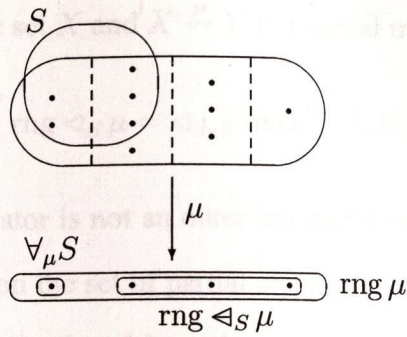

Figure 4.1:  $\text{rng } \triangleleft_S \mu = \triangleleft_{\cap_{\mu} S} \text{rng } \mu$ .

If  $S$  is a subset of the set  $X$  and  $X \xrightarrow{\mu} Y$  is a partial map, then

$$\text{rng } \triangleleft_S \mu = \triangleleft_{\cap_{\mu} S} \text{rng } \mu. \tag{4.31}$$

Thus, the range operator is not an outer law morphism from the outer law of subset removal on the set of partial maps between two sets to another outer law. Yet we have found how the range operator interacts with the removal operator. Figure 4.1 graphically displays this interaction.

(iv) We could also ask if the range operator is an outer law morphism from the outer law  $\text{phom}(X, Y)^{\triangleleft_{\mathcal{P}X}}$  to another outer law?

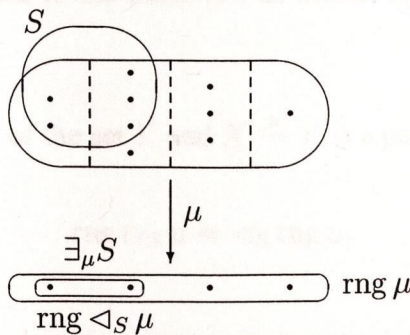

Figure 4.2:  $\text{rng } \triangleleft_S \mu = \triangleleft_{\cap_{\mu} S} \text{rng } \mu = \cap_{\mu} S$ .

If  $S$  is a subset of the set  $X$  and  $X \xrightarrow{\mu} Y$  is a partial map, then

$$\text{rng } \triangleleft_S \mu = \triangleleft_{\exists_\mu S} \text{rng } \mu = \exists_\mu S. \quad (4.32)$$

Thus, the range operator is not an outer law morphism from the outer law of subset restriction on the set of partial maps between two sets to another outer law. Yet we have found how the range operator interacts with the restriction operator. Figure 4.2 graphically displays this interaction.

- (v)  $\text{phom}(X, Y) \overset{\circlearrowright}{\triangleright}_{\mathcal{P}Y} \xrightarrow{\text{rng}} \mathcal{P}Y \overset{\circlearrowleft}{\triangleleft}_{\mathcal{P}Y}$ , the range operator is an outer law morphism from the outer law of subset range removal on the set of partial maps between two sets to the outer law of subset removal on the set of subsets of the set  $Y$ .

Thus, if  $S$  is a subset of the set  $Y$  and  $X \xrightarrow{\mu} Y$  is a partial map, then

$$\text{rng } \triangleright_S \mu = \triangleleft_S \text{rng } \mu. \quad (4.33)$$

- (vi)  $\text{phom}(X, Y) \overset{\circlearrowright}{\triangleright}_{\mathcal{P}Y} \xrightarrow{\text{rng}} \mathcal{P}Y \overset{\circlearrowleft}{\triangleleft}_{\mathcal{P}Y}$ , the range operator is an outer law morphism from the outer law of subset range restriction on the set of partial maps between two sets to the outer law of subset restriction on the set of subsets of the set  $Y$ .

Thus, if  $S$  is a subset of the set  $Y$  and  $X \xrightarrow{\mu} Y$  is a partial map, then

$$\text{rng } \triangleright_S \mu = \triangleleft_S \text{rng } \mu. \quad (4.34)$$

- (vii) One might ask if the domain operator is an outer law morphism from the outer law  $\text{phom}(X, Y) \overset{\circlearrowright}{\triangleright}_{\mathcal{P}Y}$  to another outer law?



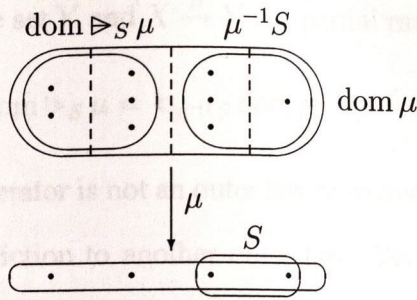

Figure 4.3:  $\text{dom} \triangleright_S \mu = \triangleleft_{\mu^{-1}S} \text{dom} \mu$ .

If  $S$  is a subset of the set  $Y$  and  $X \rightsquigarrow Y$  is a partial map, then

$$\text{dom} \triangleright_S \mu = \triangleleft_{\mu^{-1}S} \text{dom} \mu. \tag{4.35}$$

Thus, the domain operator is not an outer law morphism from the outer law of subset range removal to another outer law. Yet we have found how the domain operator interacts with the range removal operator. Figure 4.3 graphically displays this interaction.

(viii) One might also ask if the domain operator is an outer law morphism from the outer law  $\text{phom}(X, Y) \circlearrowright \triangleright_{PY}$  to another outer law?

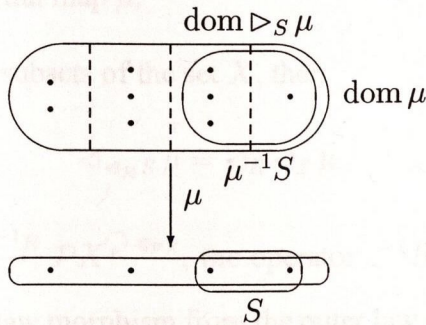

Figure 4.4:  $\text{dom} \triangleright_S \mu = \triangleleft_{\mu^{-1}S} \text{dom} \mu = \mu^{-1}S$ .

If  $S$  is a subset of the set  $Y$  and  $X \xrightarrow{\mu} Y$  is a partial map, then

$$\text{dom } \triangleright_S \mu = \triangleleft_{\mu^{-1}S} \text{dom } \mu = \mu^{-1}S. \quad (4.36)$$

Thus, the domain operator is not an outer law morphism from the outer law of subset range restriction to another outer law. Yet we have found how the domain operator interacts with the range restriction operator. Figure 4.4 graphically displays this interaction.

- (ix)  $\text{phom}(X, Y)^{\circlearrowleft \mathcal{P}X} \xrightarrow{\triangleleft_R} \text{phom}(X, Y)^{\circlearrowleft \mathcal{P}X}$ , the operator  $\triangleleft_R$  for the subset  $R$  of the set  $X$  is an outer law morphism from the outer law of subset removal on the set of partial maps between two sets to the same outer law of subset removal on the set of partial maps between two sets.

Thus, if  $S$  is a subset of the set  $X$  and  $X \xrightarrow{\mu} Y$  is a partial map, then

$$\triangleleft_R \triangleleft_S \mu = \triangleleft_S \triangleleft_R \mu. \quad (4.37)$$

- (x)  $\mathcal{P}X^{\circlearrowleft \mathcal{P}X} \xrightarrow{\triangleleft_{\mu}} \triangleleft_{\mathcal{P}X} \mu^{\circlearrowleft \mathcal{P}X}$ , the operator  $\triangleleft_{\mu}$  for the partial map  $X \xrightarrow{\mu} Y$  is an outer law morphism from the outer law of subset removal on the set of subsets of the set  $X$  to the outer law of subset removal on the set of restrictions of the partial map  $\mu$ .

Thus, if  $R$  and  $S$  are subsets of the set  $X$ , then

$$\triangleleft_{\triangleleft_R S} \mu = \triangleleft_R \triangleleft_S \mu. \quad (4.38)$$

- (xi)  $\text{phom}(X, Y)^{\circlearrowleft \mathcal{P}X} \xrightarrow{-^1 R} \mathcal{P}X^{\circlearrowleft \mathcal{P}X}$ , the operator  $-^1 R$  for the subset  $R$  of the set  $Y$  is an outer law morphism from the outer law of subset removal on the set of partial maps between two sets to the outer law of subset removal on the set of subsets of the set  $X$ .



Thus, if  $S$  is a subset of the set  $X$  and  $X \xrightarrow{\mu} Y$  is a partial map, then

$$(\triangleleft_S \mu)^{-1} R = \triangleleft_S (\mu^{-1} R). \quad (4.39)$$

(xii) One could ask if the operator  $\exists_S$  for the subset  $S$  of the set  $X$  is an outer law morphism from the outer law  $\text{phom}(X, Y)^{\circlearrowleft \ll P^X}$  to another outer law?

Let  $R$  be a subset of the set  $X$  and let  $X \xrightarrow{\mu} Y$  be a partial map. Consider the following argument:

$$\begin{aligned} & \exists_{\triangleleft_R \mu} S \\ = & \quad \{\text{existential image in terms of restriction and range}\} \\ & \text{rng } \triangleleft_S \triangleleft_R \mu \\ = & \quad \{\} \\ & \text{rng } \triangleleft_{\triangleleft_R S} \mu = \exists_{\mu} \triangleleft_R S \\ = & \quad \{\} \\ & \text{rng } \triangleleft_R \triangleleft_S \mu \\ = & \quad \{\} \\ & \triangleleft_{\forall \triangleleft_S \mu R} \text{rng } \triangleleft_S \mu \\ = & \quad \{\text{existential image in terms of restriction and range}\} \\ & \triangleleft_{\forall \triangleleft_S \mu R} \exists_{\mu} S \end{aligned}$$

Hence, we have shown that the operator  $\exists_S$  does not preserve the outer law structure

$$\exists_{\triangleleft_R \mu} S = \exists_{\mu} \triangleleft_R S = \triangleleft_{\forall \triangleleft_S \mu R} \exists_{\mu} S. \quad (4.40)$$

Thus, the operator  $\exists_S$  is not an outer law morphism from the outer law of subset removal on the set of partial maps between two sets to another outer law. Yet we have found how removal interacts with existential image.

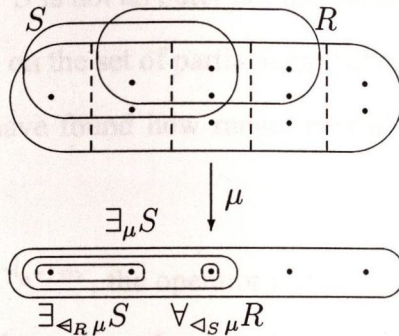

Figure 4.5:  $\exists_{\langle R \mu \rangle} S = \exists_{\mu} \langle R \rangle S = \langle \forall_{\langle S \mu \rangle} R \rangle \exists_{\mu} S$ .

(xiii) One could now ask if the operator  ${}_{-}^{-1} S$  for the subset  $S$  of the set  $Y$  is an outer law morphism from the outer law  $\text{phom}(X, Y)^{\circlearrowright \triangleright PY}$  to another outer law?

Let  $R$  be a subset of the set  $Y$  and let  $X \xrightarrow{\mu} Y$  be a partial map. Consider the following argument:

$$\begin{aligned}
 & (\triangleright_R \mu)^{-1} S \\
 = & \quad \{\text{definition of range removal}\} \\
 & (\langle \mu^{-1} R \mu \rangle)^{-1} S \\
 = & \quad \{-^{-1} S \text{ is an outer law morphism}\} \\
 & \langle \mu^{-1} R \rangle (\mu^{-1} S)
 \end{aligned}$$

Hence, we have shown that the operator  ${}_{-}^{-1} S$  does not preserve the outer



law structure

$$(\triangleright_R \mu)^{-1} S = \triangleleft_{\mu^{-1}R}(\mu^{-1}S). \tag{4.41}$$

Thus, the operator  $\_^{-1}S$  is not an outer law morphism from the outer law of subset range removal on the set of partial maps between two sets to another outer law. Yet we have found how range removal interacts with inverse image.

- (xiv)  $\mathcal{P}Y \overset{\circ}{\triangleleft}_{\mathcal{P}Y} \xrightarrow{\mu^{-1}} \mathcal{P}X \overset{\circ}{\triangleleft}_{\mu^{-1}\mathcal{P}Y}$ , the operator  $\mu^{-1}\_$  for the partial map  $X \overset{\mu}{\rightsquigarrow} Y$  is an outer law morphism from the outer law of subset removal on the set of subsets of the set  $Y$  to the outer law of subset removal after the inverse image of the partial map  $\mu$  on the set of subsets of the set  $X$ .

Thus, if  $R$  and  $S$  are subsets of the set  $Y$ , then

$$\mu^{-1}(\triangleleft_R S) = \triangleleft_{\mu^{-1}R}(\mu^{-1}S). \tag{4.42}$$

- (xv) One might ask if the operator  $\triangleright_R$  for the subset  $R$  of the set  $Y$  is an outer law morphism from the outer law  $\text{phom}(X, Y) \overset{\circ}{\triangleleft}_{\mathcal{P}X}$  to the same outer law  $\text{phom}(X, Y) \overset{\circ}{\triangleleft}_{\mathcal{P}X}$ ?

Let  $S$  be a subset of the set  $X$  and let  $X \overset{\mu}{\rightsquigarrow} Y$  be a partial map. Consider

$$\triangleright_R \mu S = \triangleleft_{\mu R}(\mu S) \tag{4.43}$$

Thus, the operator  $\triangleright_R$  is an outer law morphism from the outer law of subset removal on the set of partial maps between two sets to the same outer law

the following argument:

$$\begin{aligned}
 & \triangleright_R \triangleleft_S \mu \\
 = & \quad \{\text{definition of range restriction}\} \\
 & \triangleleft_{(\triangleleft_S \mu)^{-1}R} \triangleleft_S \mu \\
 = & \quad \{-^{-1}R \text{ is an outer law morphism}\} \\
 & \triangleleft_{\triangleleft_S(\mu^{-1}R)} \triangleleft_S \mu \\
 = & \quad \{\triangleleft_{\cdot} \triangleleft_S \mu \text{ is an outer law morphism}\} \\
 & \triangleleft_S \triangleleft_{\mu^{-1}R} \triangleleft_S \mu \\
 = & \quad \{\triangleleft_{\mu^{-1}R} \text{ is an outer law morphism}\} \\
 & \triangleleft_S \triangleleft_S \triangleleft_{\mu^{-1}R} \mu \\
 = & \quad \{\text{outer law monoid}\} \\
 & \triangleleft_{S \cup S} \triangleleft_{\mu^{-1}R} \mu \\
 = & \quad \{\text{union is idempotent}\} \\
 & \triangleleft_S \triangleleft_{\mu^{-1}R} \mu \\
 = & \quad \{\text{definition of range restriction}\} \\
 & \triangleleft_S \triangleright_R \mu
 \end{aligned}$$

Hence, we have shown that the operator  $\triangleright_R$  preserves the outer law structure

$$\triangleright_R \triangleleft_S \mu = \triangleleft_S \triangleright_R \mu. \tag{4.43}$$

Thus, the operator  $\triangleright_R$  is an outer law morphism from the outer law of subset removal on the set of partial maps between two sets to the same outer law



of subset removal on the set of partial maps between two sets,

$$\text{phom}(X, Y)^{\circlearrowleft \llcorner \mathcal{P}X} \xrightarrow{\triangleright_R} \text{phom}(X, Y)^{\circlearrowleft \llcorner \mathcal{P}X}.$$

(xvi) We could ask if the operator  $\triangleright_{\cdot} \mu$  for the partial map  $X \xrightarrow{\mu} Y$  is an outer law morphism from the outer law  $\mathcal{P}Y^{\circlearrowleft \llcorner \mathcal{P}Y}$  to the outer law  $\triangleright_{\mathcal{P}Y} \mu^{\circlearrowleft \llcorner \mu^{-1}\mathcal{P}Y}$ ?

Let  $R$  and  $S$  be subsets of the set  $Y$ . Consider the following argument:

$$\begin{aligned} & \triangleright_{\llcorner R} S \mu \\ = & \quad \{\text{definition of range restriction}\} \\ & \triangleleft_{\mu^{-1}(\llcorner R)} S \mu \\ = & \quad \{\mu^{-1}_{\cdot} \text{ is an outer law morphism}\} \\ & \triangleleft_{\llcorner (\mu^{-1}R)} (\mu^{-1}S) \mu \\ = & \quad \{\triangleleft_{\cdot} \mu \text{ is an outer law morphism}\} \\ & \llcorner_{\mu^{-1}R} \triangleleft_{\mu^{-1}S} \mu \\ = & \quad \{\text{definition of range restriction}\} \\ & \llcorner_{\mu^{-1}R} \triangleright_S \mu \end{aligned}$$

Hence, we have shown that the operator  $\triangleright_{\cdot} \mu$  preserves the outer law structure

$$\triangleright_{\llcorner R} S \mu = \llcorner_{\mu^{-1}R} \triangleright_S \mu. \tag{4.44}$$

Thus, the operator  $\triangleright_{\cdot} \mu$  is an outer law morphism from the outer law of subset removal on the set of subsets of the set  $Y$  to the outer law of subset removal after the inverse image of the partial map  $\mu$  on the set of range restrictions of the partial map  $\mu$ ,

$$\mathcal{P}Y^{\circlearrowleft \llcorner \mathcal{P}Y} \xrightarrow{\triangleright_{\cdot} \mu} \triangleright_{\mathcal{P}Y} \mu^{\circlearrowleft \llcorner \mu^{-1}\mathcal{P}Y}.$$

(xvii) One might ask if the operator  $\alpha \cdot -$  for the partial map  $Y \xrightarrow{\alpha} Z$  is an outer law morphism from the outer law  $\text{phom}(X, Y)^{\circlearrowleft \langle P, X \rangle}$  to the outer law  $\text{phom}(X, Z)^{\circlearrowleft \langle P, X \rangle}$ ? Before attempting to answer this question we must first consider how removal and pullback interact.

Let  $S$  be a subset of the set  $Y$  and consider the pullback lemma applied to the following commutative diagram

$$\begin{array}{ccccc}
 \triangleleft_R \mu^{-1} S & \hookrightarrow & \mu^{-1} S & \xrightarrow{\mu|_S} & S \\
 \downarrow & & \downarrow & & \downarrow \\
 \triangleleft_R \text{dom } \mu & \hookrightarrow & \text{dom } \mu & \xrightarrow{\mu} & Y
 \end{array}$$

The right hand square is an inverse image and thus is a pullback square. The left hand square is also a pullback square as it is an intersection of two subsets  $\triangleleft_R \text{dom } \mu$  and  $\mu^{-1} S$  of  $\text{dom } \mu$ , that is,

$$\triangleleft_R \text{dom } \mu \cap \mu^{-1} S = \triangleleft_R \mu^{-1} S.$$

Hence, by the pullback lemma the square on the left below, which is the outer ‘rectangle’ of the above diagram, equals the square on the right below, which is a pullback square

$$\begin{array}{ccc}
 \triangleleft_R \mu^{-1} S \xrightarrow{\triangleleft_R(\mu|_S)} S & & (\triangleleft_R \mu)^{-1} S \xrightarrow{(\triangleleft_R \mu)|_S} S \\
 \downarrow & = & \downarrow \\
 \triangleleft_R \text{dom } \mu \xrightarrow{\triangleleft_R \mu} Y & & \triangleleft_R \text{dom } \mu \xrightarrow{\triangleleft_R \mu} Y
 \end{array}$$

Equating the maps from the above diagrams we find

$$(\triangleleft_R \mu)|_S = \triangleleft_R(\mu|_S). \tag{4.45}$$

Thus, we have found how removal and pullback interact.



(xviii) Now let us return to our question: Is the operator  $\alpha \cdot \_$  an outer law morphism? Let  $S$  be a subset of the set  $X$  and let  $X \xrightarrow{\mu} Y$  be a partial map. Consider the following argument:

$$\begin{aligned}
 & \alpha \cdot (\triangleleft_S \mu) \\
 = & \quad \{\text{definition of partial map composition}\} \\
 & \alpha \circ (\triangleleft_S \mu)|_{\text{dom } \alpha} \\
 = & \quad \{\text{removal and pullback}\} \\
 & \alpha \circ \triangleleft_S(\mu|_{\text{dom } \alpha}) \\
 = & \quad \{\text{removal in terms of map composition}\} \\
 & \alpha \circ (\mu|_{\text{dom } \alpha} \circ (\mu^{-1} \text{ dom } \alpha \leftrightarrow \triangleleft_S \mu^{-1} \text{ dom } \alpha)) \\
 = & \quad \{\text{map composition is associative}\} \\
 & (\alpha \circ \mu|_{\text{dom } \alpha}) \circ (\mu^{-1} \text{ dom } \alpha \leftrightarrow \triangleleft_S \mu^{-1} \text{ dom } \alpha) \\
 = & \quad \{\text{removal in terms of map composition}\} \\
 & \triangleleft_S(\alpha \circ \mu|_{\text{dom } \alpha}) \\
 = & \quad \{\text{definition of partial map composition}\} \\
 & \triangleleft_S(\alpha \cdot \mu)
 \end{aligned}$$

Hence, we have shown that the operator  $\alpha \cdot \_$  preserves the outer law structure

$$\alpha \cdot (\triangleleft_S \mu) = \triangleleft_S(\alpha \cdot \mu). \tag{4.46}$$

Thus, the operator  $\alpha \cdot \_$  is an outer law morphism from the outer law of subset removal on a set of partial maps between two sets to another outer law of subset removal on a set of partial maps between two sets,

$$\text{phom}(X, Y) \overset{\circlearrowleft}{\triangleleft}_{PX} \xrightarrow{\alpha \cdot \_} \text{phom}(X, Z) \overset{\circlearrowleft}{\triangleleft}_{PX}.$$

(xviii) One might also ask if the operator  $\_ \cdot \mu$  for the partial map  $X \overset{\mu}{\rightsquigarrow} Y$  is an outer law morphism from the outer law  $\text{phom}(Y, Z) \overset{\circlearrowleft}{\leftarrow} \text{phom}(X, Z)$  to the outer law  $\text{phom}(X, Z) \overset{\circlearrowleft}{\leftarrow} \text{phom}(X, Z)$ ? Again before attempting to answer this question we must first find a relationship between inclusions, pullbacks and removals.

Let  $R$  and  $S$  be subsets of the set  $Y$ .

$$\mu^{-1}(\triangleleft_R S) = \triangleleft_{\mu^{-1}R} \mu^{-1}S,$$

Then the following diagram commutes

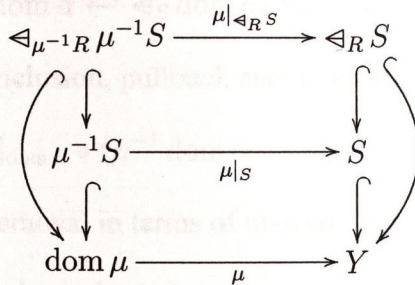

$$(S \leftarrow \triangleleft_R S) \circ \mu|_{\triangleleft_R S} = \mu|_S \circ (\mu^{-1}S \leftarrow \triangleleft_{\mu^{-1}R} \mu^{-1}S). \tag{4.47}$$

Thus, we have found a relationship between inclusions, pullbacks and removals.

Now let us return to our question: Is the operator  $\_ \cdot \mu$  an outer law morphism? Let  $S$  be a subset of the set  $Y$  and let  $Y \overset{\alpha}{\rightsquigarrow} Z$  be a partial map.



Consider the following argument:

$$\begin{aligned}
 & (\triangleleft_S \alpha) \cdot \mu \\
 = & \quad \{\text{definition of partial map composition}\} \\
 & (\triangleleft_S \alpha) \circ \mu|_{\text{dom } \triangleleft_S \alpha} \\
 = & \quad \{\text{dom is an outer law morphism}\} \\
 & (\triangleleft_S \alpha) \circ \mu|_{\triangleleft_S \text{dom } \alpha} \\
 = & \quad \{\text{removal in terms of map composition}\} \\
 & \alpha \circ (\text{dom } \alpha \leftrightarrow \triangleleft_S \text{dom } \alpha) \circ \mu|_{\triangleleft_S \text{dom } \alpha} \\
 = & \quad \{\text{inclusion, pullback and removal}\} \\
 & \alpha \circ \mu|_{\text{dom } \alpha} \circ (\mu^{-1} \text{dom } \alpha \leftrightarrow \triangleleft_{\mu^{-1}S} \mu^{-1} \text{dom } \alpha) \\
 = & \quad \{\text{removal in terms of map composition}\} \\
 & \triangleleft_{\mu^{-1}S} (\alpha \circ \mu|_{\text{dom } \alpha}) \\
 = & \quad \{\text{definition of partial map composition}\} \\
 & \triangleleft_{\mu^{-1}S} (\alpha \cdot \mu)
 \end{aligned}$$

Hence, we have shown that the operator  $\_ \cdot \mu$  preserves the outer law structure

$$(\triangleleft_S \alpha) \cdot \mu = \triangleleft_{\mu^{-1}S} (\alpha \cdot \mu). \tag{4.48}$$

Thus, the operator  $\_ \cdot \mu$  is an outer law morphism from the outer law of subset removal on a set of partial maps between two sets to the outer law of subset removal after the inverse image of the partial map  $\mu$  on a set of partial maps between two sets,

$$\text{phom}(Y, Z) \overset{\circlearrowleft}{\triangleleft}_{PY} \xrightarrow{-\mu} \text{phom}(X, Z) \overset{\circlearrowleft}{\triangleleft}_{\mu^{-1}PY}.$$

(xix) We might ask if the operator  $\text{phom}(f, g)$  for the ‘map’  $X_1 \xrightarrow{f} X_2$  and the map  $Y_1 \xrightarrow{g} Y_2$  is an outer law morphism from the outer law  $\text{phom}(X_1, Y_1) \circlearrowleft \triangleleft_{\mathcal{P}X_1}$  to the outer law  $\text{phom}(X_2, Y_2) \circlearrowleft \triangleleft_{f^{-1}\mathcal{P}X_1}$ ?

Let  $S$  be a subset of the set  $X_1$  and let  $X_1 \xrightarrow{\mu} Y_1$  be a partial map. Consider the following argument:

$$\begin{aligned}
 & \text{phom}(f, g)(\triangleleft_S \mu) \\
 = & \quad \{\text{definition of } \text{phom}(f, g)\} \\
 & g \circ (\triangleleft_S \mu) \circ f|_{\text{dom } \triangleleft_S \mu} \\
 = & \quad \{\text{partial map composition covers map composition} \\
 & \quad \text{definition of partial map composition}\} \\
 & g \cdot ((\triangleleft_S \mu) \cdot f) \\
 = & \quad \{- \cdot f \text{ is an outer law morphism}\} \\
 & g \cdot (\triangleleft_{f^{-1}S}(\mu \cdot f)) \\
 = & \quad \{g \cdot - \text{ is an outer law morphism}\} \\
 & \triangleleft_{f^{-1}S}(g \cdot (\mu \cdot f)) \\
 = & \quad \{\text{cod}(\mu \cdot f) = Y = \text{dom}(g), \\
 & \quad \text{definition of partial map composition}\} \\
 & \triangleleft_{f^{-1}S}(g \circ \mu \circ f|_{\text{dom } \mu}) \\
 = & \quad \{\text{definition of } \text{phom}(f, g)\} \\
 & \triangleleft_{f^{-1}S} \text{phom}(f, g)\mu
 \end{aligned}$$

(v) Hence, we have shown that the operator  $\text{phom}(f, g)$  preserves the outer law



(vi) structure

$$\text{phom}(f, g)(\triangleleft_S \mu) = \triangleleft_{f^{-1}S} \text{phom}(f, g)\mu. \quad (4.49)$$

Thus, the operator  $\text{phom}(f, g)$  is an outer law morphism from the outer law of subset removal on a set of partial maps between two sets to the outer law of subset removal after inverse image of the map  $f$  on a set of partial maps between two sets,

$$\text{phom}(X_1, Y_1) \overset{\triangleleft_{\mathcal{P}X_1}}{\circlearrowleft} \xrightarrow{\text{phom}(f, g)} \text{phom}(X_2, Y_2) \overset{\triangleleft_{f^{-1}\mathcal{P}X_1}}{\circlearrowleft}.$$

### 4.1.6 Monoids

A *monoid*, denoted  $(S, *, v)$ , is a non-empty set  $S$  provided with an inner law  $*$  which is everywhere defined, associative and which has an identity element  $v$ .

Here is a list of examples of monoids:

- (i)  $(\mathbb{N}, +, 0)$ , the monoid of natural numbers under natural number addition with the natural number zero as the identity element.
- (ii)  $(\mathbb{N}', \times, 1)$ , the monoid of non-zero natural numbers under natural number multiplication with the natural number one as the identity element.
- (iii)  $(\mathcal{P}X, \cup, \emptyset)$ , the monoid of subsets of the set  $X$  under subset union with the empty set as the identity element.
- (iv)  $(\mathcal{P}X, \cap, X)$ , the monoid of subsets of the set  $X$  under subset intersection with the set  $X$  as the identity element.
- (v)  $(\text{phom}(X, Y), \dagger, \theta)$ , the monoid of partial maps under partial map override with the empty partial map as the identity element.

- (vi)  $(\langle \mathcal{P}_X \mu, \cup, \theta \rangle)$ , the monoid of restrictions of the partial map  $X \xrightarrow{\mu} Y$  under partial map glueing with the empty partial map as the identity element.
- (vii)  $(\langle \mathcal{P}_X \mu, \cap, \mu \rangle)$ , the monoid of restrictions of the partial map  $X \xrightarrow{\mu} Y$  under partial map intersection with the partial map  $\mu$  as the identity element.

### 4.1.7 Monoid Morphisms

A *monoid morphism*  $m$  from the monoid  $(R, \star, u)$  to the monoid  $(S, *, v)$ , denoted  $(R, \star, u) \xrightarrow{m} (S, *, v)$ , is a map  $R \xrightarrow{m} S$  which preserves the monoid structure, that is, for all  $r_1, r_2 \in R$ ,

$$\begin{aligned} m(r_1 \star r_2) &= m(r_1) * m(r_2), \\ m(u) &= v. \end{aligned} \tag{4.50}$$

Below are a list of examples of monoid morphisms:

- (i) One might ask if the domain operator is a monoid morphism from the monoid  $(\text{phom}(X, Y), \dagger, \theta)$  to the monoid  $(\mathcal{P}X, \cup, \emptyset)$ ?

Let  $X \xrightarrow{\mu} Y$  and  $X \xrightarrow{\nu} Y$  be two partial maps and consider the following

- (ii) One might also ask if the range operator is a monoid morphism from the monoid  $(\text{phom}(X, Y), \dagger, \theta)$  to the monoid  $(\mathcal{P}Y, \cap, \emptyset)$ ?

Let  $X \xrightarrow{\mu} Y$  and  $X \xrightarrow{\nu} Y$  be two partial maps and consider the following



argument:

$$\begin{aligned}
 & \text{dom}(\mu \dagger \nu) \\
 = & \quad \{\text{override in terms of removal and extension}\} \\
 & \text{dom}(\triangleleft_{\text{dom } \nu} \mu \sqcup \nu) \\
 = & \quad \{\text{dom is an inner law morphism}\} \\
 & \text{dom } \triangleleft_{\text{dom } \nu} \mu \cup \text{dom } \nu \\
 = & \quad \{\text{dom is an outer law morphism}\} \\
 & \triangleleft_{\text{dom } \nu} \text{dom } \mu \cup \text{dom } \nu \\
 = & \quad \{\text{set theory}\} \\
 & \text{dom } \mu \cup \text{dom } \nu
 \end{aligned}$$

Hence, we have shown that the domain operator preserves monoid structure

$$\begin{aligned}
 \text{dom}(\mu \dagger \nu) &= \text{dom } \mu \cup \text{dom } \nu, \\
 \text{dom}(\theta) &= \emptyset.
 \end{aligned} \tag{4.51}$$

Thus, the domain operator is a monoid morphism from the monoid of partial maps under partial map override to the monoid of subsets of the set  $X$  under subset union,

$$(\text{phom}(X, Y), \dagger, \theta) \xrightarrow{\text{dom}} (\mathcal{P}X, \cup, \emptyset).$$

- (ii) One might also ask if the range operator is a monoid morphism from the monoid  $(\text{phom}(X, Y), \dagger, \theta)$  to the monoid  $(\mathcal{P}Y, \cup, \emptyset)$ ?

Let  $X \overset{\mu}{\rightsquigarrow} Y$  and  $X \overset{\nu}{\rightsquigarrow} Y$  be two partial maps and consider the following

argument:

$$\begin{aligned}
 & \text{rng}(\mu \dagger \nu) \\
 = & \quad \{\text{override in terms of removal and extension}\} \\
 & \text{rng}(\triangleleft_{\text{dom } \nu} \mu \sqcup \nu) \\
 = & \quad \{\text{rng is an inner law morphism}\} \\
 & \text{rng } \triangleleft_{\text{dom } \nu} \mu \cup \text{rng } \nu \\
 = & \quad \{\text{rng is not an outer law morphism}\} \\
 & \triangleleft_{(\forall_{\mu} \text{ dom } \nu)} \text{rng } \mu \cup \text{rng } \nu \\
 \Rightarrow & \quad \{\text{assuming } \forall_{\mu} \text{ dom } \nu \subseteq \text{rng } \nu\} \\
 & \text{rng } \mu \cup \text{rng } \nu
 \end{aligned}$$

Hence, we have shown that the range operator does not preserve monoid structure

$$\begin{aligned}
 \text{rng}(\mu \dagger \nu) &= \triangleleft_{(\forall_{\mu} \text{ dom } \nu)} \text{rng } \mu \cup \text{rng } \nu, \\
 \text{rng}(\theta) &= \emptyset.
 \end{aligned} \tag{4.52}$$

Thus, the range operator is not a monoid morphism from the monoid of partial maps under partial map override to the monoid of subsets of the set  $Y$  under subset union. Yet we have found how the range operator interacts with partial map override.

(iii) One might ask if the operator  $\alpha \cdot \_$  for the partial map  $Y \overset{\alpha}{\rightsquigarrow} Z$  is a monoid morphism from the monoid  $(\text{phom}(X, Y), \dagger, \theta)$  to the monoid  $(\text{phom}(X, Z), \dagger, \theta)$ ?

Let  $X \overset{\mu}{\rightsquigarrow} Y$  and  $X \overset{\nu}{\rightsquigarrow} Y$  be two partial maps and consider the following



argument:

$$\begin{aligned}
 & \alpha \cdot (\mu \dagger \nu) \\
 = & \quad \{\text{override in terms of removal and extension}\} \\
 & \alpha \cdot (\triangleleft_{\text{dom } \nu} \mu \sqcup \nu) \\
 = & \quad \{\alpha \cdot \_ \text{ is an inner law morphism}\} \\
 & \alpha \cdot (\triangleleft_{\text{dom } \nu} \mu) \sqcup \alpha \cdot \nu \\
 = & \quad \{\alpha \cdot \_ \text{ is an outer law morphism}\} \\
 & \triangleleft_{\text{dom } \nu} (\alpha \cdot \mu) \sqcup \alpha \cdot \nu
 \end{aligned}$$

Hence, we have shown that the operator  $\alpha \cdot \_$  does not preserve monoid structure

$$\begin{aligned}
 \alpha \cdot (\mu \dagger \nu) &= \triangleleft_{\text{dom } \nu} (\alpha \cdot \mu) \sqcup \alpha \cdot \nu, \\
 \alpha \cdot \theta &= \theta.
 \end{aligned} \tag{4.53}$$

Thus, the operator  $\alpha \cdot \_$  is not a monoid morphism from a monoid of partial maps under partial map override to another monoid of partial maps under partial map override. Yet we have found how the operator  $\alpha \cdot \_$  interacts with partial map override.

- (iv) One might also ask if the operator  $\_ \cdot \mu$  for the partial map  $X \xrightarrow{\mu} Y$  is a monoid morphism from the monoid  $(\text{phom}(Y, Z), \dagger, \theta)$  to the monoid  $(\text{phom}(X, Z), \dagger, \theta)$ ?

Let  $Y \xrightarrow{\alpha} Z$  and  $Y \xrightarrow{\beta} Z$  be two partial maps and consider the following

argument:

$$\begin{aligned}
 & (\alpha \dagger \beta) \cdot \mu \\
 = & \quad \{\text{override in terms of removal and extension}\} \\
 & (\triangleleft_{\text{dom } \beta} \alpha \sqcup \beta) \cdot \mu \\
 = & \quad \{- \cdot \mu \text{ is an inner law morphism}\} \\
 & (\triangleleft_{\text{dom } \beta} \alpha) \cdot \mu \sqcup \beta \cdot \mu \\
 = & \quad \{- \cdot \mu \text{ is an outer law morphism}\} \\
 & \triangleleft_{\mu^{-1} \text{ dom } \beta} (\alpha \cdot \mu) \sqcup \beta \cdot \mu \\
 = & \quad \{\text{domain of } \beta \cdot \mu\} \\
 & \triangleleft_{\text{dom}(\beta \cdot \mu)} (\alpha \cdot \mu) \sqcup \beta \cdot \mu \\
 = & \quad \{\text{override in terms of removal and extension}\} \\
 & (\alpha \cdot \mu) \dagger (\beta \cdot \mu)
 \end{aligned}$$

Hence, we have shown that the operator  $- \cdot \mu$  does preserve monoid structure

$$\begin{aligned}
 (\alpha \dagger \beta) \cdot \mu &= (\alpha \cdot \mu) \dagger (\beta \cdot \mu), \\
 \theta \cdot \mu &= \theta.
 \end{aligned} \tag{4.54}$$

Thus, the operator  $- \cdot \mu$  is a monoid morphism from a monoid of partial maps under partial map override to another monoid of partial maps under partial map override,

$$(\text{phom}(Y, Z), \dagger, \theta) \xrightarrow{-\cdot \mu} (\text{phom}(X, Z), \dagger, \theta).$$

- (v) We might ask if the operator  $\text{phom}(f, g)$  for the ‘map’  $X_1 \xrightarrow{f} X_2$  and the map  $Y_1 \xrightarrow{g} Y_2$  is a monoid morphism from the monoid  $(\text{phom}(X_1, Y_1), \dagger, \theta)$  to the monoid  $(\text{phom}(X_2, Y_2), \dagger, \theta)$ ?



(vi) Let  $X_1 \xrightarrow{\mu} Y_1$  and  $X_1 \xrightarrow{\nu} Y_1$  be two partial maps and consider the following argument:

$$\begin{aligned}
 & \text{phom}(f, g)(\mu \dagger \nu) \\
 = & \quad \{\text{override in terms of removal and extension}\} \\
 & \text{phom}(f, g)(\llcorner_{\text{dom } \nu} \mu \sqcup \nu) \\
 = & \quad \{\text{phom}(f, g) \text{ is an inner law morphism}\} \\
 & \text{phom}(f, g) \llcorner_{\text{dom } \nu} \mu \sqcup \text{phom}(f, g)\nu \\
 = & \quad \{\text{phom}(f, g) \text{ is an outer law morphism}\} \\
 & \llcorner_{f^{-1} \text{ dom } \nu} \text{phom}(f, g)\mu \sqcup \text{phom}(f, g)\nu \\
 = & \quad \{\text{domain of phom}(f, g)\nu\} \\
 & \llcorner_{\text{dom phom}(f, g)\nu} \text{phom}(f, g)\mu \sqcup \text{phom}(f, g)\nu \\
 = & \quad \{\text{override in terms of removal and extension}\} \\
 & \text{phom}(f, g)\mu \dagger \text{phom}(f, g)\nu
 \end{aligned}$$

Hence, we have shown that the operator  $\text{phom}(f, g)$  does preserve monoid structure

$$\begin{aligned}
 \text{phom}(f, g)(\mu \dagger \nu) &= \text{phom}(f, g)\mu \dagger \text{phom}(f, g)\nu, \\
 \text{phom}(f, g)(\theta) &= \theta.
 \end{aligned}
 \tag{4.55}$$

Thus, the operator  $\text{phom}(f, g)$  is a monoid morphism from a monoid of partial maps under partial map override to another monoid of partial maps under partial map override,

$$(\text{phom}(X_1, Y_1), \dagger, \theta) \xrightarrow{\text{phom}(f, g)} (\text{phom}(X_2, Y_2), \dagger, \theta).$$

- (vi)  $(\mathcal{P}X, \cup, \emptyset) \xrightarrow{\triangleleft_\mu} (\triangleleft_{\mathcal{P}X} \mu, \cap, \mu)$ , the operator  $\triangleleft_\mu$  for the partial map  $X \xrightarrow{\mu} Y$  is a monoid morphism from the monoid of subsets of the set  $X$  under subset union to the monoid of removals from the partial map  $\mu$  under partial map intersection.

Thus, if  $R$  and  $S$  are subsets of the set  $X$ , then

$$\begin{aligned} \triangleleft_{R \cup S} \mu &= \triangleleft_R \mu \cap \triangleleft_S \mu, \\ \triangleleft_\emptyset \mu &= \mu. \end{aligned} \tag{4.56}$$

- (vii)  $(\mathcal{P}X, \cup, \emptyset) \xrightarrow{\triangleleft_\mu} (\triangleleft_{\mathcal{P}X} \mu, \cup, \theta)$ , the operator  $\triangleleft_\mu$  for the partial map  $X \xrightarrow{\mu} Y$  is a monoid morphism from the monoid of subsets of the set  $X$  under subset union to the monoid of restrictions of the partial map  $\mu$  under partial map glueing.

Thus, if  $R$  and  $S$  are subsets of the set  $X$ , then

$$\begin{aligned} \triangleleft_{R \cup S} \mu &= \triangleleft_R \mu \cup \triangleleft_S \mu, \\ \triangleleft_\emptyset \mu &= \theta. \end{aligned} \tag{4.57}$$

- (viii)  $(\mathcal{P}X, \cap, X) \xrightarrow{\triangleleft_\mu} (\triangleleft_{\mathcal{P}X} \mu, \cup, \theta)$ , the operator  $\triangleleft_\mu$  for the partial map  $X \xrightarrow{\mu} Y$  is a monoid morphism from the monoid of subsets of the set  $X$  under subset intersection to the monoid of removals from the partial map  $\mu$  under partial map glueing.

Thus, if  $R$  and  $S$  are subsets of the set  $X$ , then

$$\begin{aligned} \triangleleft_{R \cap S} \mu &= \triangleleft_R \mu \cup \triangleleft_S \mu, \\ \triangleleft_X \mu &= \theta. \end{aligned} \tag{4.58}$$

- (ix)  $(\mathcal{P}X, \cap, X) \xrightarrow{\triangleleft_\mu} (\triangleleft_{\mathcal{P}X} \mu, \cap, \mu)$ , the operator  $\triangleleft_\mu$  for the partial map  $X \xrightarrow{\mu} Y$  is a monoid morphism from the monoid of subsets of the set  $X$  under



subset intersection to the monoid of restrictions of the partial map  $\mu$  under partial map intersection.

Thus, if  $R$  and  $S$  are subsets of the set  $X$ , then

$$\begin{aligned} \triangleleft_{R \cap S} \mu &= \triangleleft_R \mu \cap \triangleleft_S \mu, \\ \triangleleft_X \mu &= \mu. \end{aligned} \tag{4.59}$$

- (x)  $(\mathcal{P}Y, \cup, \emptyset) \xrightarrow{\mu^{-1}} (\mathcal{P}X, \cup, \emptyset)$ , the operator  $\mu^{-1}_-$  for the partial map  $X \xrightarrow{\mu} Y$  is a monoid morphism from the monoid of subsets of the set  $Y$  under subset union to the monoid of subsets of the set  $X$  under subset union.

Thus, if  $R$  and  $S$  are subsets of the set  $Y$ , then

$$\begin{aligned} \mu^{-1}(R \cup S) &= \mu^{-1}R \cup \mu^{-1}S, \\ \mu^{-1}\emptyset &= \emptyset. \end{aligned} \tag{4.60}$$

- (xi) One could ask if the operator  $\triangleright_- \mu$  is a monoid morphism from the monoid  $(\mathcal{P}Y, \cup, \emptyset)$  to the monoid  $(\triangleright_{\mathcal{P}X} \mu, \cup, \theta)$ ?

Let  $R$  and  $S$  be subsets of the set  $Y$ . Consider the following argument:

$$\begin{aligned} &\triangleright_{R \cup S} \mu \\ &= \quad \{\text{definition of range restriction}\} \\ &\triangleleft_{\mu^{-1}(R \cup S)} \mu \\ &= \quad \{\mu^{-1}_- \text{ is a monoid morphism}\} \end{aligned}$$

$$\begin{aligned}
 & \triangleleft_{\mu^{-1}(R \cup S)} \mu \\
 = & \quad \{ \mu^{-1}_- \text{ is a monoid morphism} \} \\
 & \triangleleft_{\mu^{-1}R \cup \mu^{-1}S} \mu \\
 = & \quad \{ \triangleleft_- \mu \text{ is a monoid morphism} \} \\
 & \triangleleft_{\mu^{-1}R} \mu \cup \triangleleft_{\mu^{-1}S} \mu \\
 = & \quad \{ \text{definition of range restriction} \} \\
 & \triangleright_R \mu \cup \triangleright_S \mu
 \end{aligned}$$

Hence, we have shown that the operator  $\triangleright_- \mu$  preserves monoid structure

$$\begin{aligned}
 \triangleright_{R \cup S} \mu &= \triangleright_R \mu \cup \triangleright_S \mu, \\
 \triangleright_{\emptyset} \mu &= \emptyset.
 \end{aligned} \tag{4.61}$$

Thus, the operator  $\triangleright_- \mu$  is a monoid morphism from the monoid of subsets of the set  $Y$  under subset union to the monoid of range restrictions of the partial map  $\mu$  under partial map glueing,

$$(\mathcal{P}Y, \cup, \emptyset) \xrightarrow{\triangleright_- \mu} (\triangleright_{\mathcal{P}Y} \mu, \cup, \emptyset).$$

### 4.1.8 Monoid Endomorphisms

A *monoid endomorphism*  $e$  of the monoid  $(S, *, v)$ , denoted  $(S, *, v)^{\mathcal{P}e}$ , is a map  $S \xrightarrow{e} S$  which preserves the monoid structure, that is, for all  $s_1, s_2 \in S$ ,

$$\begin{aligned}
 e(s_1 * s_2) &= e(s_1) * e(s_2), \\
 e(v) &= v.
 \end{aligned} \tag{4.62}$$

Here is a list of examples of monoid endomorphisms:



(i) We could ask if the removal of a subset  $S$  of the set  $X$  is a monoid endomorphism of the monoid  $(\text{phom}(X, Y), \dagger, \theta)$ ?

Let  $X \overset{\mu}{\rightsquigarrow} Y$  and  $X \overset{\nu}{\rightsquigarrow} Y$  be partial maps and consider the following argument:

$$\begin{aligned}
 & \llcorner_S(\mu \dagger \nu) \\
 = & \quad \{\text{override in terms of removal and extension}\} \\
 & \llcorner_S(\llcorner_{\text{dom } \nu} \mu \sqcup \nu) \\
 = & \quad \{\llcorner_S \text{ is an inner law endomorphism}\} \\
 & \llcorner_S \llcorner_{\text{dom } \nu} \mu \sqcup \llcorner_S \nu \\
 = & \quad \{\text{outer law monoid}\} \\
 & \llcorner_{S \cup \text{dom } \nu} \mu \sqcup \llcorner_S \nu \\
 = & \quad \{\text{set theory}\} \\
 & \llcorner_{\llcorner_S \text{ dom } \nu \cup S} \mu \sqcup \llcorner_S \nu \\
 = & \quad \{\text{outer law monoid}\} \\
 & \llcorner_{\llcorner_S \text{ dom } \nu} \llcorner_S \mu \sqcup \llcorner_S \nu \\
 = & \quad \{\text{dom is an outer law morphism}\} \\
 & \llcorner_{\text{dom } \llcorner_S \nu} \llcorner_S \mu \sqcup \llcorner_S \nu \\
 = & \quad \{\text{override in terms of removal and extension}\} \\
 & \llcorner_S \mu \dagger \llcorner_S \nu
 \end{aligned}$$

Hence, we have shown that the removal of a subset  $S$  of the set  $Y$  preserves

the monoid structure

$$\begin{aligned} \triangleleft_S(\mu \dagger \nu) &= \triangleleft_S \mu \dagger \triangleleft_S \nu, \\ \triangleleft_S \theta &= \theta. \end{aligned} \tag{4.63}$$

Thus, the removal of a subset  $S$  of the set  $Y$  is a monoid endomorphism of the monoid of partial maps under partial map override,

$$(\text{phom}(X, Y), \dagger, \theta) \circlearrowleft \triangleleft_S.$$

- (ii)  $(\text{phom}(X, Y), \dagger, \theta) \circlearrowleft \triangleleft_S$ , the restriction to a subset  $S$  of the set  $X$  is a monoid endomorphism of the monoid of partial maps under partial map override.

Thus, if  $X \overset{\mu}{\rightsquigarrow} Y$  and  $X \overset{\nu}{\rightsquigarrow} Y$  are partial maps, then

$$\begin{aligned} \triangleleft_S(\mu \dagger \nu) &= \triangleleft_S \mu \dagger \triangleleft_S \nu, \\ \triangleleft_S \theta &= \theta. \end{aligned} \tag{4.64}$$

- (iii) One could ask if the range restriction to a subset  $S$  of the set  $Y$  is a monoid endomorphism of the monoid  $(\text{phom}(X, Y), \dagger, \theta)$ ?

Let  $X \overset{\mu}{\rightsquigarrow} Y$  and  $X \overset{\nu}{\rightsquigarrow} Y$  be partial maps and consider the following argument:

$$\begin{aligned} &\triangleright_S(\mu \dagger \nu) \\ &= \quad \{\text{override in terms of removal and extension}\} \\ &\quad \triangleright_S(\triangleleft_{\text{dom } \nu} \mu \sqcup \nu) \\ &= \quad \{\triangleright_S \text{ is an outer law endomorphism}\} \\ &\quad \triangleright_S \triangleleft_{\text{dom } \nu} \mu \sqcup \triangleright_S \nu \\ &= \quad \{\triangleright_S \text{ is an outer law morphism}\} \\ &\quad \triangleleft_{\text{dom } \nu} \triangleright_S \mu \sqcup \triangleright_S \nu \end{aligned} \tag{4.65}$$



(i) Hence, we have shown that the range restriction to a subset  $S$  of the set  $Y$  does not preserve the monoid structure

$$\begin{aligned} \triangleright_S(\mu \dagger \nu) &= \triangleleft_{\text{dom } \nu} \triangleright_S \mu \sqcup \triangleright_S \nu, \\ \triangleright_S \theta &= \theta. \end{aligned} \tag{4.65}$$

Thus, the range restriction to a subset  $S$  of the set  $Y$  is not a monoid endomorphism of the monoid of partial maps under partial map override. Yet we have found how range restriction interacts with partial map override.

(iv) One could now ask if the range removal of a subset  $S$  of the set  $Y$  is a monoid endomorphism of the monoid  $(\text{phom}(X, Y), \dagger, \theta)$ ?

If  $X \overset{\mu}{\rightsquigarrow} Y$  and  $X \overset{\nu}{\rightsquigarrow} Y$  are partial maps, then

$$\begin{aligned} \triangleright_S(\mu \dagger \nu) &= \triangleleft_{\text{dom } \nu} \triangleright_S \mu \sqcup \triangleright_S \nu, \\ \triangleright_S \theta &= \theta. \end{aligned} \tag{4.66}$$

Thus, the range removal of a subset  $S$  of the set  $Y$  is not a monoid endomorphism of the monoid of partial maps under partial map override. Yet again we have found how range removal interacts with partial map override.

### 4.1.9 Outer Law Monoids

An *outer law monoid*  $(\Omega, *, u)$  on the set  $S$ , denoted  $S^{\circlearrowleft(\Omega, *, u)}$ , is an outer law from the set  $\Omega$  on the set  $S$  satisfying for all  $\omega_1, \omega_2 \in \Omega$  and for all  $s \in S$  the identities

$$\begin{aligned} (\omega_1 * \omega_2)s &= \omega_1(\omega_2 s), \\ us &= s. \end{aligned} \tag{4.67}$$

Below is a list of examples of outer law monoids:

(i)  $\text{phom}(X, Y)^{\circlearrowleft}_{\langle(\mathcal{P}X, \cup, \emptyset)\rangle}$ , the monoid of subsets of the set  $X$  under subset union with the outer law of removal of subsets of  $X$  is an outer law monoid on the set of partial maps between two sets.

Thus, if  $R$  and  $S$  are subsets of the set  $X$  and  $X \xrightarrow{\mu} Y$  is a partial map, then

$$\begin{aligned} \langle_{R \cup S} \mu &= \langle_R(\langle_S \mu), \\ \langle_{\emptyset} \mu &= \mu. \end{aligned} \tag{4.68}$$

(ii)  $\text{phom}(X, Y)^{\circlearrowleft}_{\langle(\mathcal{P}X, \cap, X)\rangle}$ , the monoid of subsets of the set  $X$  under subset intersection with the outer law of restriction to subsets of  $X$  is an outer law monoid on the set of partial maps between two sets.

Thus, if  $R$  and  $S$  are subsets of the set  $X$  and  $X \xrightarrow{\mu} Y$  is a partial map, then

$$\begin{aligned} \langle_{R \cap S} \mu &= \langle_R(\langle_S \mu), \\ \langle_X \mu &= \mu. \end{aligned} \tag{4.69}$$

(iii) We could now ask if the monoid of subsets of the set  $Y$  under subset intersection with the outer law of range removal of subsets of  $Y$  is an outer law monoid on the set of partial maps between two sets?

Let  $R$  and  $S$  be subsets of the set  $Y$  and let  $X \xrightarrow{\mu} Y$  be a partial map.



(iv) Consider the following argument:

$$\begin{aligned}
 & \triangleright_{R \cup S} \mu \\
 = & \quad \{\text{definition of range removal}\} \\
 & \triangleleft_{\mu^{-1}(R \cup S)} \mu \\
 = & \quad \{\mu^{-1} \_ \text{ is a monoid morphism}\} \\
 & \triangleleft_{\mu^{-1}R \cup \mu^{-1}S} \mu \\
 = & \quad \{\text{set theory}\} \\
 & \triangleleft_{\triangleleft_{\mu^{-1}S} \mu^{-1}R \cup \mu^{-1}S} \mu \\
 = & \quad \{\text{outer law monoid}\} \\
 & \triangleleft_{\triangleleft_{\mu^{-1}S} \mu^{-1}R} (\triangleleft_{\mu^{-1}S} \mu) \\
 = & \quad \{\_^{-1}R \text{ is not an outer law morphism,} \\
 & \quad \text{definition of range removal}\} \\
 & \triangleleft_{(\triangleright_S \mu)^{-1}R} (\triangleright_S \mu) \\
 = & \quad \{\text{definition of range removal}\} \\
 & \triangleright_R (\triangleright_S \mu)
 \end{aligned}$$

Hence, we have shown that the outer law of range removal of subsets of  $Y$  satisfies the identities

$$\triangleright_{R \cup S} \mu = \triangleright_R (\triangleright_S \mu), \tag{4.70}$$

$$\triangleright_{\emptyset} \mu = \mu.$$

Thus, the monoid of subsets of the set  $Y$  under subset union with the outer law of range removal of subsets of  $Y$  is an outer law monoid on the set of partial maps between two sets:

$$\text{phom}(X, Y) \circlearrowright_{\triangleright_{(\mathcal{P}Y, \cup, \emptyset)}}.$$



(iv)  $\text{phom}(X, Y)^{\circlearrowleft}_{\triangleright(\mathcal{P}Y, \cap, Y)}$ , the monoid of subsets of the set  $Y$  under subset intersection with the outer law of range restriction to subsets of  $Y$  is an outer law monoid on the set of partial maps between two sets.

Thus, if  $R$  and  $S$  are subsets of the set  $Y$  and  $X \overset{\mu}{\rightsquigarrow} Y$  is a partial map, then

$$\triangleright_{R \cap S} \mu = \triangleright_R(\triangleright_S \mu), \tag{4.71}$$

$$\triangleright_Y \mu = \mu.$$

## 4.2 Summary

This chapter extends the operator calculus and refines the algebraic foundations of the Irish School of the VDM. A summary of the existing partial map operator relationships is listed. Additionally, new partial map operator relationships are identified. For example, one has considered the interaction of the range partial map operator with other operators, resulting in (i) the identification of a number of new partial map operators, and (ii) strengthening of an identity involving range. Some of these partial map operator relationships could not be classified under the original algebraic foundations, that of, monoids and monoid morphisms. One refines the original algebraic foundation to that of inner laws and inner law morphisms, and outer laws and outer law morphisms, with the result of classifying the omitted operator relationships. The boundary between the categorical foundations and algebraic foundations is clearly defined. From a pedagogical perspective one now has a general approach to proofs involving partial map override: does one have (i) an inner law morphism and (ii) an outer law morphism?



School of the VDM with the result that several theorems that were not classified originally are now classified.

(iv) Gave categorical semantics to part of the theory in terms of topos theory.

## Chapter 5

# Conclusion

### 5.1 Achievements

The operational calculus developed by the Irish School of the VDM has a life of its own independent of its applications. This thesis has been interested in the operational calculus that arose from the modelling of information systems. Again, one was not overly interested in the models themselves but the operational calculus itself.

As one believes that the operational calculus which the Irish School of the VDM generates has not been analysed enough, one has invested time in the analysis of this operational calculus, with the following results:

- (i) Refined and improved the operational calculus of the Irish School of the VDM.
- (ii) Altered the philosophy of the Irish School of the VDM by encouraging a shift away from a pure constructive approach that allowed the embracing of the totality of mathematics.
- (iii) Refined the algebraic foundations of the operational calculus of the Irish



School of the VDM with the result that operator identities that were not classified originally are now classified.

- (iv) Gave categorical semantics to partial map override in terms of topos theory.

The Irish School of the VDM has significantly shifted from its original beginnings of simple algebraic properties towards a significant operational calculus and in addition a categorical and topos theoretical outlook.

## 5.1 Achievements

The key achievements in the second chapter on Indexed Operations and Operators come from an extension to the operator calculus and an expansion to the constructive philosophy of the School by embracing classical mathematics. Specifically:

- (i) Recorded the conceptual historical development of indexed operations and operators within the Irish School of the VDM. The key discussions and publications have also been recorded and placed in context.
- (ii) Classified operators on indexed monoids and identified their algebra. Specifically, there are two methods to define indexed operators. In addition, a collection of free operators on indexed monoids are identified.
- (iii) Stated that there are two types of indexed monoids and recorded their origins.
- (iv) Proved, using a classical approach, the monoidal properties of each type of indexed monoid, where the second proof has been inspired by Lawvere and Schanuel (1997).



The key achievements in the third chapter on the Categorical Definition of Override arise by giving a topos foundation to the override operator. This chapter is the beginnings of a categorical foundations for the Irish School of the VDM.

By giving a categorical foundation to override, one has introduced the concept of override to topos theory, thus allowing the concept of override to be interpreted within different worlds or topoi. When one gives a topos foundation to override, one considers in detail what override is and what override depends upon.

The logic underlying the Irish School of the VDM is intuitionistic logic. This is verified as one can define override in an elementary topos where the logic is intuitionistic. This is not surprising as the School has always espoused a constructive philosophy. In effect, this verifies the constructive philosophy of the School.

Some highlighted achievements are:

- (i) The operation of overriding one partial map, from an object  $X$  to an object  $Y$ , by another partial map, from the object  $X$  to the object  $Y$ , depends on the shape on  $X$ , that is, how the subobjects of  $X$  are related to each other and to the whole object  $X$ .
- (ii) Removal is defined in an elementary topos such that when a subobject is removed from another subobject, the result will always be a subobject. This gives a mathematical expression to Dr. Mac An Airchinnigh's philosophical viewpoint on removal and enables one to define override successfully in an elementary topos.
- (iii) Interpret override's behavior in three explicit worlds.

- (iv) By giving a topos semantics to override one has answered an outstanding question within the School.
- (v) The work within this chapter highlights the logic of the Irish School which is intuitionistic logic.

The key achievements in the fourth chapter on Algebraic Foundations Reconsidered arise from successfully bridging the gaps in the known algebra of the Irish School of the VDM. Specifically, the chapter extends the operator calculus and improves upon the algebraic foundations. The operator calculus is extended by identifying opportunities in the original calculus. The algebraic foundations are reconsidered and improved upon by refining the original foundations, with the result that operator expressions that were not classified originally are now classified.

Some chapter achievements highlighted:

- (i) The refined algebraic foundations are: (i) inner laws and inner law morphisms, and (ii) outer laws and outer law morphisms. These foundations are generalizations of the original foundations which were: (i) monoids, and (ii) monoid morphisms — including endomorphisms and admissible morphisms.
- (ii) Identified how override and partial map composition interacts. This was an improvement upon a lemma by Mac an Airchinnigh (1990, 416).
- (iii) Introduced the universal image operator to the Irish School which was the key operator to describe the interaction of range and removal.
- (iv) Analysed the Irish School's concept of a map iterator, with the result of cor-



recting an oversight in the original definition and verified its functor properties.

- (v) Verified a selection of new and old operator relationships using the refined algebraic foundations.
- (vi) The boundary between the algebraic and the categorical foundation is laid bare. Specifically, one finds that to verify an algebraic relationship it depends upon the categorical interpretations of the the operators involved.

## 5.2 Directions for Future Research

Directions for future research are:

- (i) The interaction of pullback and partial map override will unify two existing interactions: (i) inverse image and partial map override, and (ii) inverse image and subset union. One developed a specialized version of this in Hughes and Donnelly (1997). One was unaware of this at the time. The development of this interaction is an opportunity to extend the operator calculus.
- (ii) The Lawvere and Schanuel (1997) modelling philosophy is similar to that of the Irish School of the VDM, excluding the fact that Lawvere and Schanuel are missing the concept of partial map override. Each community would benefit by the strengthening of their inter-relationships.
- (iii) From a pedagogical perspective, the development of models to illustrate the new elements within the operator calculus would be beneficial.

- (iv) From the perspective of completeness it would be beneficial to place indexed operations entirely within a topos theoretical framework. One believes that this is entirely possible as indexed operations may be expressed in terms of partial map override and direct power operations. Both partial map override and direct power operations may be placed within a topos theoretical framework.
- (v) Partial map override has been successfully placed within a topos theoretical framework. A topos has a natural logic associated within it — a typed intuitionistic logic. Hence, this typed intuitionistic logic underlies/complements the operational calculus. This relationship should be further analysed as it will highlight the behavior of the operational calculus.
- (vi) Perhaps one of the most interesting directions for future work is the realization that there is a large collection of hidden operators waiting to be analysed. Additionally, their behavior is entirely determined by intuitionistic logic. These hidden operators may be found by considering an operator concept. This operator concept is interpreted in different topoi, with the results that different types of operators are identified. If the topoi are built for the topos of sets, then the different types of operators may be used with the topos of sets.

For example, there is the concept of removal. This concept was interpreted in different topoi, with the result that different types of removal were identified. However, the collection of topoi that one considered are built from the topos of sets. Therefore, one can take these different types of removal and use them within the topos of sets.



The discovery of these hidden operators will extend the operator calculus.

(vii) Partial map override has been placed within a topos theoretical framework.

What impact does this have on the general theory of topoi? If any?

(viii) One would be interested in revisiting the work in chapter four to place all the partial map operators within a topos theoretical framework. The starting point for this would be the fact that the collection of partial maps between two objects in a topos can be internalized using the partial map classifier within a topos.

# Appendix A

## Partial Maps & Operators

This appendix defines a partial map and a collection of partial map operators. The operators are defined using:

- (i) set comprehension and partial comprehension,
- (ii) partial map operators previously defined, and
- (iii) map composition.

This appendix is very much in the spirit of Lawvere (1975, 6 – 7). Lawvere begins with sets and maps, and develops a collection of operators on the maps. Here one also begins with sets and maps, and develops partial maps and a collection of operators on partial maps.

A functor between categories is developed which will create the collection of partial maps between two given sets. This functor gives rise to another partial map operator.



## A.1 Partial Maps

A *partial map*  $\mu$  from a set  $X$  to a set  $Y$ , denoted  $X \overset{\mu}{\rightsquigarrow} Y$ , is a map  $\mu$  from a subset  $\text{dom } \mu$  of  $X$  to  $Y$ ,

$$X \overset{\mu}{\rightsquigarrow} Y \equiv \text{dom } \mu \subseteq X \wedge \text{dom } \mu \xrightarrow{\mu} Y. \quad (\text{A.1})$$

The *set of partial maps* from a set  $X$  to a set  $Y$  is denoted by  $X \rightarrow Y$  or by  $\text{phom}(X, Y)$ .

## A.2 Partial Map Operators

The operations defined on partial maps in this section are domain, application, range, extension, removal, restriction, glueing, intersection, override, inverse image, direct or existential image, universal image, range removal, range restriction and partial map composition.

The partial map operators are presented in terms of: (i) set comprehension and partial map comprehension, (ii) partial map operators previously defined and (iii) map composition.

### A.2.1 Domain

The *domain* of a partial map  $X \overset{\mu}{\rightsquigarrow} Y$  is denoted  $\text{dom } \mu$  and is defined to be the subset of  $X$  given by taking the domain of the map  $\text{dom } \mu \xrightarrow{\mu} Y$  associated with the partial map  $\mu$ .

### A.2.2 Codomain

The *codomain* of a partial map  $X \overset{\mu}{\rightsquigarrow} Y$  is denoted  $\text{cod } \mu$  and is defined to be the set  $Y$ .

### A.2.3 Application

A partial map  $X \overset{\mu}{\rightsquigarrow} Y$  may be *applied* to an element  $x$  of  $\text{dom } \mu$ , denoted  $\mu(x)$ , and is simply the application of the map  $\text{dom } \mu \xrightarrow{\mu} Y$  associated with the partial map  $\mu$  to the element  $x$ .

### A.2.4 Range or Image

The *range* or *image* of a partial map  $X \overset{\mu}{\rightsquigarrow} Y$  is denoted by  $\text{rng } \mu$  or  $\text{img } \mu$  and is defined by

$$\text{rng } \mu = \text{img } \mu = \{\mu(x) \mid x \in \text{dom } \mu\}. \quad (\text{A.2})$$

### A.2.5 Extension

If two partial maps  $X \overset{\mu}{\rightsquigarrow} Y$  and  $X \overset{\nu}{\rightsquigarrow} Y$  have disjoint domains,

$$\text{dom } \mu \cap \text{dom } \nu = \emptyset, \quad (\text{A.3})$$

then the partial map  $\mu$  may be *extended* by the partial map  $\nu$ , denoted  $\mu \sqcup \nu$ , and is defined by

$$\mu \sqcup \nu = [x \mapsto y \mid (x \in \text{dom } \mu \wedge \mu(x) = y) \vee (x \in \text{dom } \nu \wedge \nu(x) = y)]. \quad (\text{A.4})$$

The extension of the partial map  $\mu$  by the partial map  $\nu$  may be defined as the sum of the map  $\text{dom } \mu \xrightarrow{\mu} Y$  with the map  $\text{dom } \nu \xrightarrow{\nu} Y$  in the category  $\mathcal{S}$  and also



as the sum of the inclusion map  $\text{dom } \mu \hookrightarrow X$  with the inclusion map  $\text{dom } \nu \hookrightarrow X$  in the category  $\mathcal{S}$

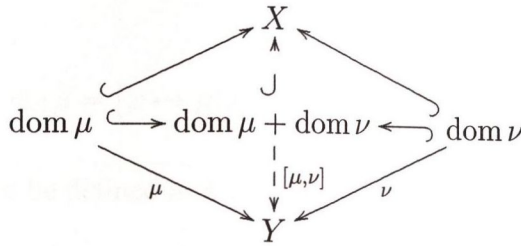

If  $\text{dom } \mu \cap \text{dom } \nu = \emptyset$ , then  $\text{dom } \mu + \text{dom } \nu = \text{dom } \mu \cup \text{dom } \nu$ .

### A.2.6 Removal

A subset  $S$  of the set  $X$  may be *removed* from a partial map  $X \xrightarrow{\mu} Y$ , denoted  $\triangleleft_S \mu$ , and is defined by

$$\triangleleft_S \mu = [x \mapsto \mu(x) \mid x \in \text{dom } \mu \wedge x \notin S]. \tag{A.5}$$

Removal may also be defined as a composition of maps

$$\triangleleft_S \mu = \mu \circ (\text{dom } \mu \hookrightarrow \triangleleft_S \text{dom } \mu). \tag{A.6}$$

One easily obtains from the above definition the domain of the partial map  $\mu$  with the subset  $S$  removed,

$$\text{dom}(\triangleleft_S \mu) = \triangleleft_S \text{dom } \mu. \tag{A.7}$$

If  $X \xrightarrow{\mu} Y$  and  $X \xrightarrow{\nu} Y$  are partial maps with disjoint domains, then the removal and extension operators will be inverse operations

$$\triangleleft_{\text{dom } \nu}(\mu \sqcup \nu) = \mu. \tag{A.8}$$

### A.2.7 Restriction

A partial map  $X \overset{\mu}{\rightsquigarrow} Y$  may be *restricted* by a subset  $S$  of  $X$ , denoted  $\triangleleft_S \mu$ , and is defined by

$$\triangleleft_S \mu = [x \mapsto \mu(x) \mid x \in \text{dom } \mu \wedge x \in S]. \quad (\text{A.9})$$

Restriction may also be defined as a composition of maps

$$\triangleleft_S \mu = \mu \circ (\text{dom } \mu \leftarrow \triangleleft_S \text{dom } \mu). \quad (\text{A.10})$$

One easily obtains from the above definition the domain of the partial map  $\mu$  restricted to the subset  $S$ ,

$$\text{dom}(\triangleleft_S \mu) = \triangleleft_S \text{dom } \mu. \quad (\text{A.11})$$

A *partition* of a partial map  $X \overset{\mu}{\rightsquigarrow} Y$  is induced by a subset  $S$  of  $X$  using the removal and restriction operators

$$\mu = \triangleleft_S \mu \sqcup \triangleleft_{S^c} \mu. \quad (\text{A.12})$$

### A.2.8 Glueing

If two partial maps  $X \overset{\mu}{\rightsquigarrow} Y$  and  $X \overset{\nu}{\rightsquigarrow} Y$  agree on the intersection of their domains,

$$\triangleleft_{\text{dom } \nu} \mu = \triangleleft_{\text{dom } \mu} \nu, \quad (\text{A.13})$$

then the partial map  $\mu$  may be *glued* to the partial map  $\nu$ , denoted  $\mu \cup \nu$ , and is defined by

$$\mu \cup \nu = [x \mapsto y \mid (x \in \text{dom } \mu \wedge \mu(x) = y) \vee (x \in \text{dom } \nu \wedge \nu(x) = y)]. \quad (\text{A.14})$$



Glueing may also be defined in terms of extension, removal and restriction

$$\mu \cup \nu = \triangleleft_{\text{dom } \nu} \mu \sqcup \triangleleft_{\text{dom } \nu} \mu \sqcup \triangleleft_{\text{dom } \mu} \nu. \quad (\text{A.15})$$

### A.2.9 Intersection

A partial map  $X \xrightarrow{\mu} Y$  may be *intersected* with a partial map  $X \xrightarrow{\nu} Y$ , denoted  $\mu \cap \nu$ , and is defined by

$$\mu \cap \nu = [x \mapsto y \mid x \in (\text{dom } \mu \cap \text{dom } \nu) \wedge \mu(x) = \nu(x)]. \quad (\text{A.16})$$

### A.2.10 Override

A partial map  $X \xrightarrow{\mu} Y$  may be *overridden* by a partial map  $X \xrightarrow{\nu} Y$ , denoted  $\mu \dagger \nu$ , and is defined by

$$\begin{aligned} \mu \dagger \nu = [x \mapsto y \mid (x \in \triangleleft_{\text{dom } \nu} \text{dom } \mu \wedge \mu(x) = y) \\ \vee (x \in \text{dom } \nu \wedge \nu(x) = y)]. \end{aligned} \quad (\text{A.17})$$

Override may also be defined in terms of removal and extension

$$\mu \dagger \nu = \triangleleft_{\text{dom } \nu} \mu \sqcup \nu. \quad (\text{A.18})$$

We note that the extension and glueing operators are special cases of the override operator

$$\begin{aligned} \text{dom } \mu \cap \text{dom } \nu = \emptyset & \Rightarrow \mu \dagger \nu = \mu \sqcup \nu, \\ \triangleleft_{\text{dom } \nu} \mu = \triangleleft_{\text{dom } \mu} \nu & \Rightarrow \mu \dagger \nu = \mu \cup \nu. \end{aligned} \quad (\text{A.19})$$

### A.2.11 Inverse Image

The *inverse image* of a subset  $S$  of the set  $Y$  under the partial map  $X \overset{\mu}{\rightsquigarrow} Y$  is denoted  $\mu^{-1}S$  and is defined by

$$\mu^{-1}S = \{x \in \text{dom } \mu \mid \mu(x) \in S\}. \tag{A.20}$$

Figure A.1 graphically displays the behaviour of inverse image. A commutative

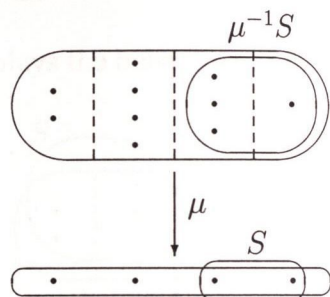

Figure A.1: Inverse image of set  $S$  under partial map  $\mu$ .

square diagram is associated with an inverse image:

$$\begin{array}{ccc} \mu^{-1}S & \xrightarrow{\mu|_S} & S \\ \downarrow & & \downarrow \\ \text{dom } \mu & \xrightarrow{\mu} & Y \end{array}$$

This commutative square is in fact a *pullback square* in the category  $\mathcal{S}$ , where the arrows with curved tails denote *inclusion maps*.



### A.2.12 Direct or Existential Image

The *direct image* or *existential image* of a subset  $S$  of the set  $X$  under the partial map  $X \xrightarrow{\mu} Y$  is denoted by  $\mu(S)$  or by  $\exists_{\mu}S$  and is defined by

$$\begin{aligned} \mu(S) &= \exists_{\mu}S = \{y \in \text{rng } \mu \mid \exists x \in \text{dom } \mu: \mu(x) = y \wedge x \in S\} \\ &= \{\mu(x) \mid x \in (\text{dom } \mu \cap S)\} \\ &= \text{rng } \triangleleft_S \mu. \end{aligned} \tag{A.21}$$

Figure A.2 graphically displays the behaviour of direct or existential image.

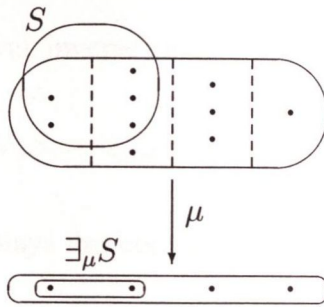

Figure A.2: Direct or existential image of set  $S$  under partial map  $\mu$ .

### A.2.13 Universal Image

The *universal image* of a subset  $S$  of the set  $X$  under the partial map  $X \xrightarrow{\mu} Y$  is denoted  $\forall_{\mu}S$  and is defined by

$$\begin{aligned} \forall_{\mu}S &= \{y \in \text{rng } \mu \mid \forall x \in \text{dom } \mu: \mu(x) = y \Rightarrow x \in S\} \\ &= \{y \in \text{rng } \mu \mid \mu^{-1} \{y\} \subseteq S\}. \end{aligned} \tag{A.22}$$

Figure A.3 graphically displays the behaviour of universal image.

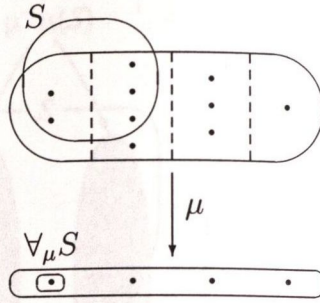

Figure A.3: Universal image of set  $S$  under partial map  $\mu$ .

Dr. Mac an Airchinnigh has also demonstrated that universal image may be expressed in terms of removal, inverse image and direct image or existential image

$$\forall_{\mu} S = \triangleleft_{\mu(\triangleleft_S \mu^{-1} \mu(S))} \mu(S). \tag{A.23}$$

Figure A.4 graphically displays this construction.

### A.2.14 Range Removal

A subset  $S$  of the set  $Y$  may be *range removed* from the partial map  $X \xrightarrow{\mu} Y$ , denoted  $\triangleright_S \mu$ , and is defined by

$$\triangleright_S \mu = [x \mapsto \mu(x) \mid x \in \text{dom } \mu \wedge \mu(x) \notin S]. \tag{A.24}$$

Range removal may also be defined in terms of the removal and inverse image operators

$$\triangleright_S \mu = \triangleleft_{\mu^{-1} S} \mu. \tag{A.25}$$



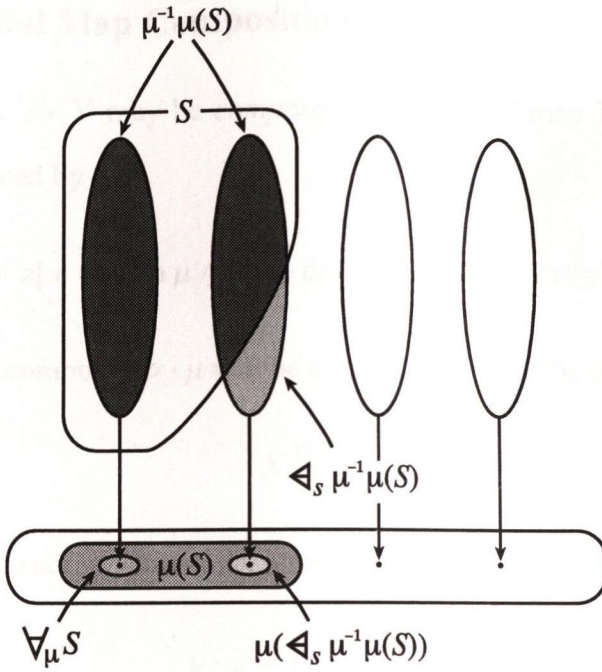

Figure A.4: Universal image may be expressed in terms of removal, inverse image and direct image or existential image  $\forall_{\mu} S = \mu(\mu^{-1}\mu(S))$ .

### A.2.15 Range Restriction

A partial map  $X \overset{\mu}{\rightsquigarrow} Y$  may be *range restricted* by a subset  $S$  of  $Y$ , denoted  $\triangleright_S \mu$ , and is defined by

$$\triangleright_S \mu = [x \mapsto \mu(x) \mid x \in \text{dom } \mu \wedge \mu(x) \in S]. \quad (\text{A.26})$$

Range restriction may also be defined in terms of the restriction and inverse image operators

$$\triangleright_S \mu = \mu^{-1} S \mu. \quad (\text{A.27})$$

### A.2.16 Partial Map Composition

A partial map  $X \xrightarrow{\mu} Y$  may be composed with a partial map  $Y \xrightarrow{\nu} Z$ , denoted  $\nu \cdot \mu$ , and is defined by

$$\nu \cdot \mu = [x \mapsto z \mid x \in \text{dom } \mu \wedge \exists y \in \text{dom } \nu: \mu(x) = y \wedge \nu(y) = z]. \quad (\text{A.28})$$

We note that the composite  $\nu \cdot \mu$  will be a partial map from the set  $X$  to the set  $Z$ ,

$$X \xrightarrow{\nu \cdot \mu} Z.$$

In fact partial map composition may also be defined as a composition of maps

$$\nu \cdot \mu = \nu \circ \mu|_{\text{dom } \nu}. \quad (\text{A.29})$$

The following commutative diagram

$$\begin{array}{ccccc} \mu^{-1} \text{dom } \nu & \xrightarrow{\mu|_{\text{dom } \nu}} & \text{dom } \nu & \xrightarrow{\nu} & Z \\ \downarrow & & \downarrow & & \\ X & \xleftarrow{\quad} & \text{dom } \mu & \xrightarrow{\quad \mu} & Y \end{array}$$

shows the maps involved in the above composition. One easily obtains from the commutative diagram the domain of the composite partial map

$$\text{dom}(\nu \cdot \mu) = \mu^{-1} \text{dom } \nu. \quad (\text{A.30})$$

We note that the composition of maps is a special case of the composition of partial maps

$$\text{cod } \mu = \text{dom } \nu \quad \Rightarrow \quad \nu \cdot \mu = \nu \circ \mu. \quad (\text{A.31})$$



### A.3 The phom Functor

This section will develop phom as a *functor* from the product category  $\mathcal{S}^{\text{op}} \times \mathcal{S}$  to the category  $\mathcal{S}$ ,

$$\mathcal{S}^{\text{op}} \times \mathcal{S} \xrightarrow{\text{phom}} \mathcal{S}.$$

Firstly, phom assigns to each pair of sets  $\langle X, Y \rangle$  in the category  $\mathcal{S}^{\text{op}} \times \mathcal{S}$  the set of partial maps between the pair of sets  $\text{phom}(X, Y)$  in the category  $\mathcal{S}$ ,

$$\text{phom}: \langle X, Y \rangle \mapsto \text{phom}(X, Y). \tag{A.32}$$

Secondly, phom assigns to each pair of maps  $\langle f, g \rangle$ , from a pair of sets  $\langle X_1, Y_1 \rangle$  to a pair of sets  $\langle X_2, Y_2 \rangle$ , in the category  $\mathcal{S}^{\text{op}} \times \mathcal{S}$  the map  $\text{phom}(f, g)$ , from the set  $\text{phom}(X_1, Y_1)$  of partial maps between the first pair of sets to the set  $\text{phom}(X_2, Y_2)$  of partial maps between the second pair of sets, in the category  $\mathcal{S}$ ,

$$\text{phom}: \left\langle \begin{array}{cc} X_1 & Y_1 \\ \downarrow f & \downarrow g \\ X_2 & Y_2 \end{array} \right\rangle \mapsto \begin{array}{c} \text{phom}(X_1, Y_1) \\ \downarrow \text{phom}(f, g) \\ \text{phom}(X_2, Y_2) \end{array}. \tag{A.33}$$

We name the map  $\text{phom}(f, g)$  a *phom map* and we define its effect on a partial map  $X_1 \overset{\mu}{\rightsquigarrow} Y_1$  by

$$\begin{aligned} \text{phom}(f, g)\mu &= [x_2 \mapsto y_2 \mid x_2 \in X_2 \wedge y_2 \in Y_2 \\ &\wedge \exists x_1 \in \text{dom } \mu: f(x_2) = x_1 \wedge g(\mu(x_1)) = y_2]. \end{aligned} \tag{A.34}$$

A question may arise from the above definition: Why has the ‘map’  $X_1 \overset{f}{\rightarrow} X_2$  changed direction to a map  $X_2 \overset{f}{\rightarrow} X_1$ ? The reason for this is that every ‘map’  $X_1 \overset{f}{\rightarrow} X_2$  in  $\mathcal{S}^{\text{op}}$  arises from a map  $X_2 \overset{f}{\rightarrow} X_1$  in  $\mathcal{S}$ . We note that the image of the

partial map  $\mu$  under the phom map will be a partial map from the set  $X_2$  to the set  $Y_2$ ,

$$X_2 \xrightarrow{\text{phom}(f,g)\mu} Y_2.$$

Traditionally within the Irish School of the VDM this phom map is called a *partial map iterator* and is denoted by  $(f \rightarrow g)$ . In fact the phom map is a composition of maps

$$\text{phom}(f, g)\mu = g \circ \mu \circ f|_{\text{dom } \mu}. \tag{A.35}$$

The following commutative diagram

$$\begin{array}{ccccc} f^{-1} \text{dom } \mu & \xrightarrow{f|_{\text{dom } \mu}} & \text{dom } \mu & \xrightarrow{\mu} & Y_1 \xrightarrow{g} Y_2 \\ \downarrow & & \downarrow & & \\ X_2 & \xrightarrow{f} & X_1 & & \end{array}$$

shows the maps involved in the above composition. One easily obtains from the commutative diagram the domain of the image of the partial map  $\mu$  under the phom map

$$\text{dom}(\text{phom}(f, g)\mu) = f^{-1} \text{dom } \mu. \tag{A.36}$$

Having defined the effect of phom on both pairs of sets and pairs of maps in  $\mathcal{S}^{\text{op}} \times \mathcal{S}$  we must check that phom preserves the categorical structure:

- (i) phom preserves identity maps, that is, phom assigns to a pair of identity maps on a pair of sets  $\langle X, Y \rangle$  the identity map on the set  $\text{phom}(X, Y)$ ,

$$\text{phom}(1_X, 1_Y) = 1_{\text{phom}(X, Y)}; \tag{A.37}$$



(ii)  $\text{phom}$  preserves composition of maps, that is,  $\text{phom}$  assigns the composite of the pairs of maps  $\left\langle \begin{array}{c} X_1 \\ \downarrow f_1 \\ X_2 \end{array}, \begin{array}{c} Y_1 \\ \downarrow g_1 \\ Y_2 \end{array} \right\rangle$  and  $\left\langle \begin{array}{c} X_2 \\ \downarrow f_2 \\ X_3 \end{array}, \begin{array}{c} Y_2 \\ \downarrow g_2 \\ Y_3 \end{array} \right\rangle$  to the composition of their images,

$$\text{phom}(\langle f_2, g_2 \rangle \circ \langle f_1, g_1 \rangle) = \text{phom}(f_2, g_2) \circ \text{phom}(f_1, g_1). \quad (\text{A.38})$$

Firstly, we will prove that  $\text{phom}$  preserves identity maps. Let  $X \overset{\mu}{\rightsquigarrow} Y$  be a partial map and consider the following argument:

$$\begin{aligned} & \text{phom}(1_X, 1_Y)\mu \\ = & \quad \{\text{definition of the phom map}\} \\ & 1_Y \circ \mu \circ 1_X|_{\text{dom } \mu} \\ = & \quad \{\text{dom } \mu \subset X\} \\ & 1_Y \circ \mu \circ 1_{\text{dom } \mu} \\ = & \quad \{\text{identity law}\} \\ & \mu \end{aligned}$$

Equating the first expression with the last expression we find:

$$\begin{aligned} & \text{phom}(1_X, 1_Y)\mu = \mu \\ \equiv & \quad \{\text{evaluation at } \mu\} \\ & \text{phom}(1_X, 1_Y) = 1_{\text{phom}(X, Y)} \end{aligned}$$

Thus,  $\text{phom}$  preserves identity maps.

Before proceeding to the second proof that  $\text{phom}$  preserves map composition we must remind ourselves of the *pullback lemma* from category theory.

The pullback lemma states: if a diagram of the form

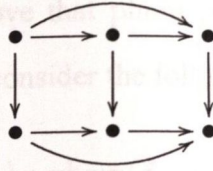

commutes, then

- (i) if the two small squares are pullbacks, then the outer ‘rectangle’, with top and bottom edges the evident composites, is a pullback;
- (ii) if the outer ‘rectangle’ and the right hand square are pullbacks then so is the left square.

Let  $S$  be a subset of the set  $X_1$  and consider the pullback lemma applied to the following commutative diagram

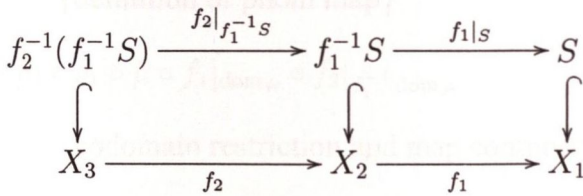

The two small squares are inverse images and thus they are pullback squares. Hence, by the pullback lemma the square on the left below, which is the outer ‘rectangle’ of the above diagram, equals the square on the right below, which is a pullback square.

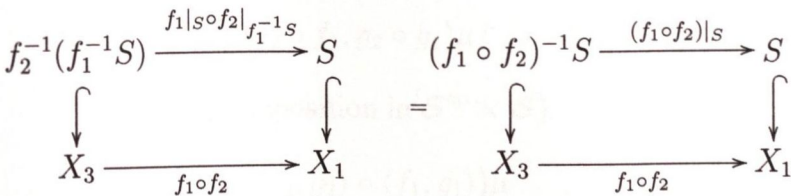

Equating the maps from the above diagrams we find

$$(f_1 \circ f_2)|_S = f_1|_S \circ f_2|_{f_1^{-1}S}. \tag{A.39}$$



Thus, we have found how codomain restriction and map composition interact.

Secondly, we will now prove that phom preserves map composition. Let  $X_1 \xrightarrow{\mu} Y_1$  be a partial map and consider the following argument:

$$\begin{aligned}
 & (\text{phom}(f_2, g_2) \circ \text{phom}(f_1, g_1))\mu \\
 = & \quad \{\text{composition, application}\} \\
 & \text{phom}(f_2, g_2) \text{phom}(f_1, g_1)\mu \\
 = & \quad \{\text{definition of the phom map}\} \\
 & g_2 \circ \text{phom}(f_1, g_1)\mu \circ f_2|_{\text{dom phom}(f_1, g_1)\mu} \\
 = & \quad \{\text{domain of the phom map}\} \\
 & g_2 \circ \text{phom}(f_1, g_1)\mu \circ f_2|_{f_1^{-1} \text{ dom } \mu} \\
 = & \quad \{\text{definition of phom map}\} \\
 & g_2 \circ g_1 \circ \mu \circ f_1|_{\text{dom } \mu} \circ f_2|_{f_1^{-1} \text{ dom } \mu} \\
 = & \quad \{\text{codomain restriction and map composition}\} \\
 & g_2 \circ g_1 \circ \mu \circ (f_1 \circ f_2)|_{\text{dom } \mu} \\
 = & \quad \{\text{composition in } \mathcal{S}^{\text{op}}\} \\
 & g_2 \circ g_1 \circ \mu \circ (f_2 \circ f_1)|_{\text{dom } \mu} \\
 = & \quad \{\text{definition of the phom map}\} \\
 & \text{phom}(f_2 \circ f_1, g_2 \circ g_1)\mu \\
 = & \quad \{\text{composition in } \mathcal{S}^{\text{op}} \times \mathcal{S}\} \\
 & \text{phom}(\langle f_2, g_2 \rangle \circ \langle f_1, g_1 \rangle)\mu
 \end{aligned}$$

Equating the last expression with the first expression we find:

$$\begin{aligned} \text{phom}(\langle f_2, g_2 \rangle \circ \langle f_1, g_1 \rangle) \mu &= (\text{phom}(f_2, g_2) \circ \text{phom}(f_1, g_1)) \mu \\ \equiv \quad \{ \text{evaluation at } \mu \} \\ \text{phom}(\langle f_2, g_2 \rangle \circ \langle f_1, g_1 \rangle) &= \text{phom}(f_2, g_2) \circ \text{phom}(f_1, g_1) \end{aligned}$$

Thus,  $\text{phom}$  preserves map composition.

Hence, we have proven that  $\text{phom}$  is a functor from the product category  $\mathcal{S}^{\text{op}} \times \mathcal{S}$  to the category  $\mathcal{S}$ .



## Appendix B

# Category & Topos Theory

This appendix on category and topos theory has been inspired by Lawvere and Schanuel's (1997) exceptional book on this subject.

A category  $\mathcal{C}$  consists of the *data*:

- (i) A collection of things called *objects* denoted by  $A, B, C, \dots$
- (ii) A collection of things called *maps* denoted by  $f, g, h, \dots$
- (iii) For each map  $f$ , one object as the *domain* of  $f$  and one object as the *codomain* of  $f$ . To indicate that  $f$  is a map, with domain  $A$  and codomain  $B$ , write  $A \xrightarrow{f} B$  or  $f: A \rightarrow B$  and say ' $f$  is a map from  $A$  to  $B$ .'
- (iv) For each object  $A$  an *identity map*, which has domain  $A$  and codomain  $A$ , this map is denoted by  $1_A$ , so  $A \xrightarrow{1_A} A$  is one of the maps from  $A$  to  $A$ .
- (v) For each pair of maps  $A \xrightarrow{f} B \xrightarrow{g} C$ , *composite map*  $A \xrightarrow{g \text{ following } f} C$ . This map is denoted by  $A \xrightarrow{g \circ f} C$  and sometimes pronounced ' $g$  of  $f$ '.

satisfying the following *rules*:

(i) *Identity Laws*: If  $A \xrightarrow{f} B$ , then  $1_B \circ f = f$  and  $f \circ 1_A = f$

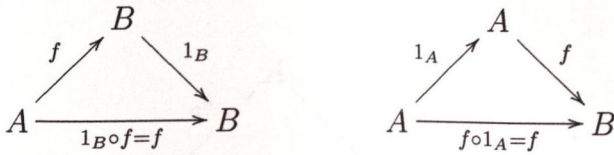

(ii) *Associative Law*: If  $A \xrightarrow{f} B \xrightarrow{g} C \xrightarrow{h} D$ , then  $(h \circ g) \circ f = h \circ (g \circ f)$

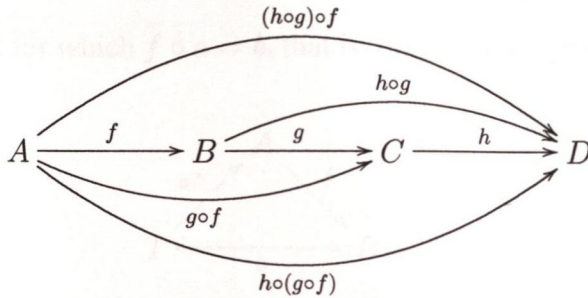

## B.1 Possible Map Properties

### B.1.1 Isomorphism

A map  $A \xrightarrow{f} B$  is called an *isomorphism*, or *invertible map*, if there is a map  $B \xrightarrow{g} A$  for which  $g \circ f = 1_A$  and  $f \circ g = 1_B$ . A map  $g$  related to  $f$  by satisfying these equations is called an *inverse for  $f$* . Two objects  $A$  and  $B$  are said to be *isomorphic* if there is at least one isomorphism between them.

If  $B \xrightarrow{g} A$  and  $B \xrightarrow{h} A$  are both inverses for  $A \xrightarrow{f} B$ , then  $g = h$ . If  $A \xrightarrow{f} B$  has an inverse, then the one and only inverse for  $f$  is denoted by  $f^{-1}$  and is read as ‘ $f$ -inverse’, or ‘the inverse of  $f$ ’.

### B.1.2 Section and Choice Problem

A *section* for a map  $A \xrightarrow{f} B$  is a map  $B \xrightarrow{s} A$  for which  $f \circ s = 1_B$ .



The *choice* or *lifting* problem: Given  $f$  and  $b$  as shown below, what are all  $a$ , if any, for which  $b = f \circ a$ ?

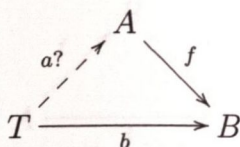

If a map  $A \xrightarrow{f} B$  has a section, then for any  $T$  and for any map  $T \xrightarrow{b} B$  there exists a map  $T \xrightarrow{a} A$  for which  $f \circ a = b$ , that is, every choice problem

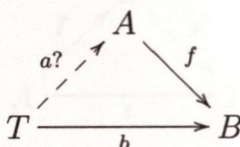

has a solution. If this is so the map  $f$  is said to be *surjective for maps from  $T$* .

### B.1.3 Epimorphism

A map  $A \xrightarrow{f} B$  is an *epimorphism*, or *epic map*, if it satisfies:

For every object  $T$  and every pair of maps  $B \begin{array}{c} \xrightarrow{t_1} \\ \xrightarrow{t_2} \end{array} T$  from  $B$  to  $T$ ,

$$t_1 \circ f = t_2 \circ f \text{ implies } t_1 = t_2.$$

To indicate that a map  $A \xrightarrow{f} B$  is an epimorphism; instead of writing a plain arrow like  $\rightarrow$  replace the open arrow head,  $\rightrightarrows$ , with a solid arrow head,  $\blacktriangleright$ , so that  $A \xrightarrow{f} \blacktriangleright B$  indicates that  $f$  is an epimorphism.

If a map  $A \xrightarrow{f} B$  has a section, then the map  $f$  will be an epimorphism.

### B.1.4 Retraction and Determination Problem

A *retraction* for a map  $A \xrightarrow{f} B$  is a map  $B \xrightarrow{r} A$  for which  $r \circ f = 1_A$ .

The *determination* or *extension* problem: Given  $f$  and  $t$  as shown below, what are all  $g$ , if any, for which  $t = g \circ f$ ?

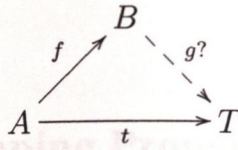

If a map  $A \xrightarrow{f} B$  has a retraction, then for any  $T$  and for any map  $A \xrightarrow{t} T$ , there is a map  $B \xrightarrow{g} T$  for which  $g \circ f = t$ , that is, every determination problem

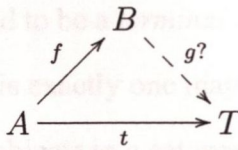

has a solution.

### B.1.5 Inclusion or Monomorphism

A map  $A \xrightarrow{f} B$  is an *inclusion* or *monomorphism*, or *monic map* if it satisfies:

For every object  $T$  and every pair of maps  $T \xrightarrow{a_1} A$  and  $T \xrightarrow{a_2} A$  from  $T$  to  $A$ ,

$$f \circ a_1 = f \circ a_2 \text{ implies } a_1 = a_2.$$

To indicate that a map  $A \xrightarrow{f} B$  is an inclusion; instead of writing a plain arrow like  $\rightarrow$  put a little hook,  $\subset$ , on its tail, so that  $A \xrightarrow{f} B$  indicates that  $f$  is an inclusion map.

If a map  $A \xrightarrow{f} B$  has a retraction, then the map  $f$  will be an inclusion or monomorphism.

### B.1.6 Idempotent

An endomap  $A \xrightarrow{e} A$  is *idempotent* if  $e \circ e = e$ .



If the map  $B \xrightarrow{r} A$  is a retraction of the map  $A \xrightarrow{f} B$  (equivalently the map  $f$  is a section of the map  $r$ ), then letting  $e = f \circ r$  will define an endomap  $B \xrightarrow{e} B$  which will be idempotent.

## B.2 Universal Mapping Properties

### B.2.1 Terminals

An object  $T$  in a category is said to be a *terminal object* of the category if for each object  $X$  of the category there is exactly one map  $X \rightarrow T$ .

If  $T_1, T_2$  are both terminal objects in a category, then there is exactly one map  $T_1 \rightarrow T_2$ , and this map is an isomorphism.

Since different choices of terminal object are isomorphic one is chosen and denoted  $1$ .

If  $1$  is a terminal object of a category and if  $X$  is any object of the category, then a map  $1 \rightarrow X$  will be an inclusion map and is called a *point* of  $X$ .

### B.2.2 Initials

An object  $I$  in a category is said to be an *initial object* of the category if for each object  $X$  of the category there is exactly one map  $I \rightarrow X$ .

If  $I_1, I_2$  are both initial objects in a category, then there is exactly one map  $I_1 \rightarrow I_2$ , and this map is an isomorphism.

Since different choices of initial object are isomorphic one is chosen and denoted  $0$ .

### B.2.3 Products

An object  $P$  together with a pair of maps  $P \xrightarrow{p_1} B_1, P \xrightarrow{p_2} B_2$  is called a *product* of  $B_1$  and  $B_2$  if for each object  $T$  and each pair of maps  $T \xrightarrow{f_1} B_1, T \xrightarrow{f_2} B_2$ , there is exactly one map  $T \xrightarrow{f} P$  for which both  $f_1 = p_1 f$  and  $f_2 = p_2 f$

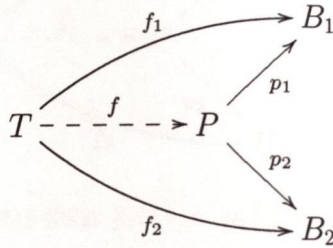

that is, for which  $f_1(t) = p_1(f(t))$  and  $f_2(t) = p_2(f(t))$  for all  $S \xrightarrow{t} T$ .

The map  $f$ , uniquely determined by the maps  $f_1$  and  $f_2$ , is called the *product map* of  $f_1$  and  $f_2$ , and this map is denoted by  $\langle f_1, f_2 \rangle$ . The maps  $p_1$  and  $p_2$  are called *projection* maps for the product.

If  $P, p_1, p_2$  and also  $Q, q_1, q_2$  are both products with projection maps of the same pair of objects  $B_1, B_2$  in a given category, then there is exactly one map  $P \xrightarrow{g} Q$  for which  $p_1 = q_1 g$  and  $p_2 = q_2 g$ , and this map is an isomorphism.

Since different choices of product with projection maps for  $B_1$  and  $B_2$  are isomorphic one is chosen and denote  $B_1 \times B_2$  with  $B_1 \xleftarrow{p_1} B_1 \times B_2 \xrightarrow{p_2} B_2$ . Now the ‘exactly one’ condition on  $p_1$  and  $p_2$  is abbreviated as:

$$B_1 \xleftarrow{p_1} B_1 \times B_2 \xrightarrow{p_2} B_2 \quad \text{induces} \quad \frac{T \rightarrow B_1 \times B_2}{T \rightarrow B_1, T \rightarrow B_2}$$

### B.2.4 Pullbacks or Fibered Products

Given two maps  $B_1 \xrightarrow{g} Y$  and  $B_2 \xrightarrow{h} Y$  with common codomain in a category, an object  $P$  together with maps  $P \xrightarrow{p_1} B_1$  and  $P \xrightarrow{p_2} B_2$ , is called a *pullback* of



the pair  $g, h$ , or fibered product of  $B_1$  and  $B_2$  over  $Y$ , if  $p_1g = p_2h$  and for each object  $T$  and each pair of maps  $T \xrightarrow{f_1} B_1, T \xrightarrow{f_2} B_2$  for which  $gf_1 = hf_2$ , there is exactly one map  $T \xrightarrow{f} P$ , for which  $f_1 = p_1f$  and  $f_2 = p_2f$

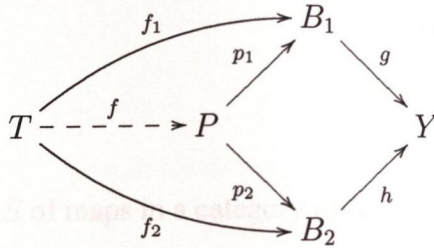

that is, if  $g(f_1(t)) = h(f_2(t))$  then  $f_1(t) = p_1(f(t))$  and  $f_2(t) = p_2(f(t))$  for all  $S \xrightarrow{t} T$ .

The inner square  $p_1, g, p_2, h$  of the diagram is called a *pullback square*, or *Cartesian square*. The maps  $p_1$  and  $p_2$  are called *projection maps* for the pullback or fibered product. The map  $p_1$  is said to arise by *pulling back map  $h$  along map  $g$* , and map  $p_2$  arises by *pulling back map  $g$  along map  $h$* .

If  $P, p_1, p_2$  and also  $Q, q_1, q_2$  are both pullbacks with projection maps for the same pair of maps  $B_1 \xrightarrow{g} Y, B_2 \xrightarrow{h} Y$  or equivalently fibered products with projection maps of the same pair of objects  $B_1, B_2$  over  $Y$  in a given category, then there is exactly one map  $P \xrightarrow{k} Q$  for which  $p_1 = q_1k$  and  $p_2 = q_2k$ , and this map is an isomorphism.

Since different choices of pullback with projection maps for the same pair of maps  $B_1 \xrightarrow{g} Y, B_2 \xrightarrow{h} Y$  or equivalently fibered product with projection maps for  $B_1$  and  $B_2$  over  $Y$  are isomorphic one is chosen and denoted  $B_1 \times_Y B_2$  with  $B_1 \xleftarrow{p_1} B_1 \times_Y B_2 \xrightarrow{p_2} B_2$ . Now the ‘exactly one’ condition on  $p_1$  and  $p_2$  is abbrevi-

ated as:

$$B_1 \xleftarrow{p_1} B_1 \times_Y B_2 \xrightarrow{p_2} B_2 \quad \text{induces} \quad \frac{T \rightarrow B_1 \times_Y B_2}{\begin{array}{ccc} T & \longrightarrow & B_1 \\ \downarrow & & \downarrow g \\ B_2 & \xrightarrow{h} & Y \end{array}}$$

### B.2.5 Sums

A pair  $B_1 \xrightarrow{j_1} S, B_2 \xrightarrow{j_2} S$  of maps in a category makes  $S$  a *sum* of  $B_1$  and  $B_2$  if for each object  $Y$  and each pair  $B_1 \xrightarrow{g_1} Y, B_2 \xrightarrow{g_2} Y$ , there is exactly one map  $S \xrightarrow{g} Y$ , for which both  $g_1 = gj_1$  and  $g_2 = gj_2$

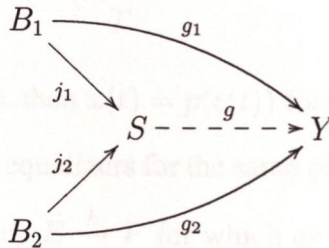

that is, for which  $g_1(b_1) = g(j_1(b_1))$  and  $g_2(b_2) = g(j_2(b_2))$  for all  $S_1 \xrightarrow{b_1} B_1, S_2 \xrightarrow{b_2} B_2$ .

The map  $g$ , uniquely determined by the maps  $g_1$  and  $g_2$ , is called the *sum map* of  $g_1$  and  $g_2$ . This map is denoted by  $\begin{cases} g_1 \\ g_2 \end{cases}$  or by  $[g_1, g_2]$ . The maps  $j_1$  and  $j_2$  are called *injection* maps for the sum.

If  $j_1, j_2, S$  and also  $k_1, k_2, T$  are both sums with injection maps of the same pair of objects  $B_1, B_2$  in a given category, then there is exactly one map  $S \xrightarrow{f} T$  for which  $k_1 = fj_1$  and  $k_2 = fj_2$ , and this map is an isomorphism.

Since different choices of sum with injection maps for  $B_1$  and  $B_2$  are isomorphic one is chosen and denoted  $B_1 + B_2$  with  $B_1 \xrightarrow{j_1} B_1 + B_2 \xleftarrow{j_2} B_2$ . Now the



'exactly one' condition on  $j_1$  and  $j_2$  is abbreviated as:

$$B_1 \xrightarrow{j_1} B_1 + B_2 \xleftarrow{j_2} B_2 \quad \text{induces} \quad \frac{B_1 + B_2 \rightarrow Y}{B_1 \rightarrow Y, B_2 \rightarrow Y}$$

### B.2.6 Equalizers

An object  $E$  together with a map  $E \xrightarrow{p} X$  is an *equalizer* for a parallel pair of maps  $X \xrightleftharpoons[f]{g} Y$ , if  $fp = gp$  and for each  $T \xrightarrow{x} X$  for which  $fx = gx$ , there is exactly one map  $T \xrightarrow{e} E$  for which  $x = pe$

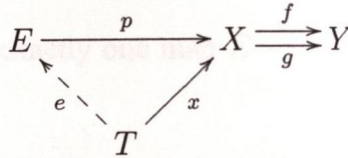

that is, if  $f(x(t)) = g(x(t))$ , then  $x(t) = p(e(t))$  for all  $S \xrightarrow{t} T$ .

If both  $E, p$  and  $F, q$  are equalizers for the same parallel pair of maps  $X \xrightleftharpoons[f]{g} Y$ , then there is exactly one map  $E \xrightarrow{h} F$  for which  $qh = p$ , and this map is an isomorphism.

Since different choices of equalizers for the same parallel pair of maps  $X \xrightleftharpoons[f]{g} Y$  are isomorphic one is chosen and denoted  $E$  with  $E \xrightarrow{p} X$ . Now the 'exactly one' condition on  $p$  is abbreviated as:

$$E \xrightarrow{p} X \xrightleftharpoons[f]{g} Y \quad \text{induces} \quad \frac{T \rightarrow E}{T \rightarrow X \xrightleftharpoons[f]{g} Y}$$

An equalizer  $E \xrightarrow{p} X$  of a parallel pair of maps  $X \xrightleftharpoons[f]{g} Y$  is an inclusion map.

### B.2.7 Coequalizers

An object  $E$  together with a map  $Y \xrightarrow{p} E$  is a *coequalizer* for a parallel pair of maps  $X \rightrightarrows Y$ , if  $pf = pg$  and for each  $Y \xrightarrow{t} T$  for which  $tf = tg$ , there is exactly one map  $E \xrightarrow{e} T$  for which  $t = ep$

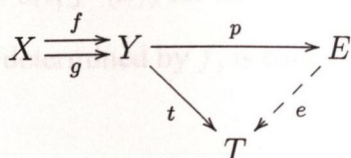

If both  $p, E$  and  $q, F$  are coequalizers for the same parallel pair of maps  $X \rightrightarrows Y$ , then there is exactly one map  $E \xrightarrow{h} F$  for which  $hp = q$ , and this map is an isomorphism.

Since different choices of coequalizers for the same parallel pair of maps  $X \rightrightarrows Y$  are isomorphic one is chosen and denoted  $E$  with  $Y \xrightarrow{p} E$ . Now the ‘exactly one’ condition on  $p$  is abbreviated as:

$$X \begin{array}{c} \xrightarrow{f} \\ \xrightarrow{g} \end{array} Y \xrightarrow{p} E \quad \text{induces} \quad \frac{E \rightarrow T}{X \begin{array}{c} \xrightarrow{f} \\ \xrightarrow{g} \end{array} Y \rightarrow T}$$

A coequalizer  $Y \xrightarrow{p} E$  of a parallel pair of maps  $X \rightrightarrows Y$  is an epimorphism.

### B.2.8 Map Objects

Given two objects  $T, Y$  in a category with products, an object  $M$  together with a map  $T \times M \xrightarrow{e} Y$  is an *object of maps from  $T$  to  $Y$  with evaluation map*, provided  $M$  and  $e$  satisfy: For each object  $X$  and each map  $T \times X \xrightarrow{f} Y$ , there is exactly



one map, to be denoted  $X \xrightarrow{f^\top} M$ , for which  $f = e(1_T \times f^\top)$

$$\begin{array}{ccc}
 T \times X & \xrightarrow{1_T \times f^\top} & T \times M \\
 \searrow f & & \swarrow e \\
 & Y &
 \end{array}$$

that is, for which  $f(t, x) = e(t, f^\top(x))$  for all  $S \xrightarrow{t} T, S \xrightarrow{x} X$ .

The map  $f^\top$ , uniquely determined by  $f$ , is called the *name of  $f$* . The map  $e$  is called the *evaluation map*.

If  $M_1, e_1$  and  $M_2, e_2$  both serve as map objects with evaluation map for maps from  $T$  to  $Y$  in a given category, then there is exactly one map  $M_1 \xrightarrow{g} M_2$  for which  $e_1 = e_2(1_T \times g)$ , and this map is an isomorphism.

Since different choices of map objects with evaluation map for maps from  $T$  to  $X$  are isomorphic one is chosen and denoted  $Y^T$  with  $T \times Y^T \xrightarrow{e} Y$ . Now the ‘exactly one’ condition on  $e$  is abbreviated as:

$$T \times Y^T \xrightarrow{e} Y \quad \text{induces} \quad \frac{X \rightarrow Y^T}{T \times X \rightarrow Y}$$

### B.2.9 Truth-Value Object or Subobject Classifier

A *subobject*, or *part*, of an object  $X$  is an object  $S$ , which is the *shape* of the part of  $X$ , together with an inclusion  $S \xrightarrow{\iota} X$ , which determines how the shape  $S$  of the part is *inserted* into the object  $X$ .

In a category with a terminal object  $1$ , an object  $\Omega$  together with a map  $1 \xrightarrow{true} \Omega$ , is called a *truth-value object*, or *subobject classifier* for the category, if for each object  $X$  and each part  $S \xrightarrow{\iota} X$  of  $X$ , there is exactly one map  $X \xrightarrow{\varphi_S} \Omega$  such that for each figure  $T \xrightarrow{x} X$  of  $X$ ,

$$\varphi_S x = true_T \quad \text{if and only if} \quad x \in_X S, \iota$$

where  $true_T$  denotes the composite of the unique map  $T \rightarrow \mathbf{1}$  with  $\mathbf{1} \xrightarrow{true} \Omega$  and  $x \in_X S$ ,  $\iota$  denotes the fact that the figure  $x$  is included in the part  $S$ ,  $\iota$ , that is, there is a map  $T \xrightarrow{s} S$  such that  $x = \iota s$

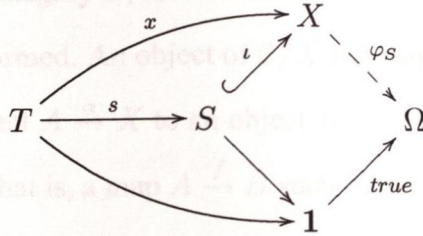

This condition is equivalent to the condition that for each object  $X$  and each part  $S \hookrightarrow X$  of  $X$ , there is exactly one map  $X \xrightarrow{\varphi_S} \Omega$  such that the diagram

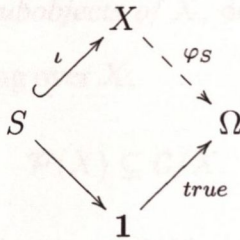

commutes and forms a pullback square.

The map  $\varphi_S$ , uniquely determined by the part  $S, \iota$ , is called the *classifying* or *characteristic* map of the part  $S, \iota$ . The map  $true$  is called the *truth* map.

If  $\Omega_1, true_1$  and  $\Omega_2, true_2$  are truth-value objects with truth map in a given category, then there is exactly one map  $\Omega_1 \xrightarrow{\varphi_{true_1}} \Omega_2$  for which  $true_2 = \varphi_{true_1} true_1$ , and this map is an isomorphism.

Since different choices of truth-value objects with truth map in a category are isomorphic one is chosen and denoted  $\Omega$  with  $\mathbf{1} \xrightarrow{true} \Omega$ . Now the ‘exactly one’ condition on  $true$  is abbreviated as:

$$\mathbf{1} \xrightarrow{true} \Omega \quad \text{induces} \quad \frac{S \hookrightarrow X}{X \xrightarrow{\varphi_S} \Omega}$$



### B.3 Parts of an Object: Toposes

#### B.3.1 Categories $\mathcal{C}/X$ and $\mathcal{P}(X)$

If  $X$  is an object in a category  $\mathcal{C}$ , then another category  $\mathcal{C}/X$  of objects *varying over* object  $X$  can be formed. An object of  $\mathcal{C}/X$  is a map of  $\mathcal{C}$  with codomain  $X$ , and a map from an object  $A \xrightarrow{\alpha} X$  to an object  $B \xrightarrow{\beta} X$  is a map of  $\mathcal{C}$  from  $A$  to  $B$  which  $\beta$  takes to  $\alpha$ , that is, a map  $A \xrightarrow{f} B$  such that  $\beta f = \alpha$

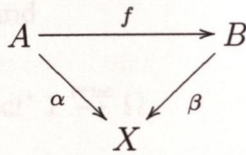

The *category of parts or subobjects of  $X$* , denoted by  $\mathcal{P}(X)$ , is part of the category  $\mathcal{C}/X$  of objects varying over  $X$ ,

$$\mathcal{P}(X) \subseteq \mathcal{C}/X.$$

The objects of  $\mathcal{P}(X)$  are all objects  $\alpha$  of  $\mathcal{C}/X$  which are *inclusion maps in  $\mathcal{C}$* , that is, the objects of  $\mathcal{P}(X)$  are the parts or subobjects of  $X$  in  $\mathcal{C}$ . The maps of  $\mathcal{P}(X)$  are all the maps between its objects in  $\mathcal{C}/X$ ; but given any two objects  $A \xrightarrow{\alpha} X$  and  $B \xrightarrow{\beta} X$  in  $\mathcal{P}(X)$ , there is at *most one* map  $A \xrightarrow{f} B$  in  $\mathcal{C}$  such that  $\beta f = \alpha$

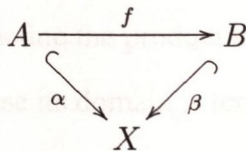

Thus, the category of parts of a given object in any category is a *poset*. To indicate that there is a map, necessarily unique, from object  $A \xrightarrow{\alpha} X$  to object  $B \xrightarrow{\beta} X$  in  $\mathcal{P}(X)$  one uses the notation

$$A, \alpha \subseteq_X B, \beta$$

read as ‘part  $A, \alpha$  is *included* in part  $B, \beta$  over  $X$ ’. The notation may be abbreviated either as  $A \subseteq_X B$  or as  $\alpha \subseteq_X \beta$ .

### B.3.2 Toposes and Logic

A category  $\mathcal{C}$  is a *topos* if and only if:

- (i)  $\mathcal{C}$  has  $0, 1, \times, +$ , and for every object  $X, \mathcal{C}/X$  has products,
- (ii)  $\mathcal{C}$  has map objects  $Y^X$ , and
- (iii)  $\mathcal{C}$  has a ‘truth-value object’  $1 \xrightarrow{\text{true}} \Omega$ .

The condition that for every object  $X$  the category  $\mathcal{C}/X$  of objects varying over  $X$  has products is equivalent to the condition that there is a pullback with projection maps in  $\mathcal{C}$  for every pair of maps with common codomain in  $\mathcal{C}$ .

If a category  $\mathcal{C}$  is a topos, then the category  $\mathcal{C}/X$  of objects varying over  $X$  will be a topos for every object  $X$  in  $\mathcal{C}$ . This is known as (part of) the *Fundamental Theorem of Topoi*.

#### Conjunction & Subobject Intersection

Form the product  $\Omega \times \Omega$  and define the product map  $1 \xrightarrow{\langle \text{true}, \text{true} \rangle} \Omega \times \Omega$ . This map is an inclusion map because its domain is terminal; therefore this is a subobject of the object  $\Omega \times \Omega$  and it has a classifying or characteristic map  $\Omega \times \Omega \xrightarrow{\wedge} \Omega$ . This classifying map is the logical operation of *conjunction*. The property of this operation is that for any  $T \xrightarrow{\langle a, b \rangle} \Omega \times \Omega$  where  $a$  and  $b$  are maps from  $T$  to  $\Omega$ , the



composite

$$T \begin{array}{c} \xrightarrow{\langle a, b \rangle} \Omega \times \Omega \xrightarrow{\wedge} \Omega \\ \xrightarrow{a \wedge b} \Omega \end{array}$$

has the property that

$$a \wedge b = \text{true}_T \quad \text{if and only if} \quad \langle a, b \rangle \in_{\Omega \times \Omega} \mathbf{1}, \langle \text{true}, \text{true} \rangle$$

which means precisely

$$a = \text{true}_T \quad \text{and} \quad b = \text{true}_T.$$

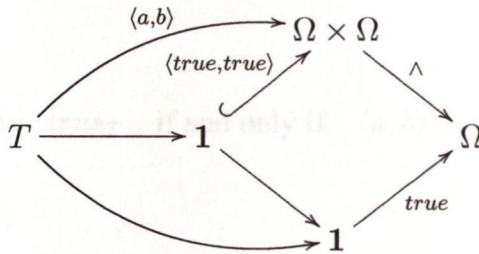

Now, because  $T \xrightarrow{a} \Omega$  is a map whose codomain is  $\Omega$ , by the defining property of  $\Omega$ , it must be the classifying map of some subobject of the object  $T$ ,  $A \xrightarrow{\alpha} T$ . In the same way  $T \xrightarrow{b} \Omega$  is the classifying map of some other subobject of the object  $T$ ,  $B \xrightarrow{\beta} T$ , and the subobject of the object  $T$  classified by  $T \xrightarrow{a \wedge b} \Omega$  is called the *intersection* of  $A, \alpha$  and  $B, \beta$ , denoted by  $(A \wedge B) \xrightarrow{\alpha \wedge \beta} T$ .

The intersection of two subobjects of  $T$  is, in fact, the product of these objects considered as objects of  $\mathcal{P}(T)$ . The product of two objects of  $\mathcal{P}(T)$  is the product of these objects considered as objects of  $\mathcal{C}/X$ . Thus, the ‘exactly one’ condition on the projection maps of the product of two objects in  $\mathcal{P}(T)$  becomes:

$$\beta_1 \subseteq_T \beta_1 \wedge \beta_2 \subseteq_T \beta_2 \quad \text{induces} \quad \frac{\xi \subseteq_T \beta_1 \wedge \beta_2}{\xi \subseteq_T \beta_1 \quad \text{and} \quad \xi \subseteq_T \beta_2}$$

**Implication**

From the parallel pair of maps  $\Omega \times \Omega \xrightarrow[p_1]{\wedge} \Omega$  form their equalizer map  $\subseteq \xrightarrow{e} \Omega \times \Omega$ .

This map is an inclusion map because it is the equalizer of a parallel pair of maps; therefore this is a subobject and it has a classifying or characteristic map  $\Omega \times \Omega \rightrightarrows \Omega$ . This classifying map is the logical operation of *implication*. The property of this operation is that for any  $T \xrightarrow{\langle a,b \rangle} \Omega \times \Omega$  where  $a$  and  $b$  are maps from  $T$  to  $\Omega$ , the composite

$$\begin{array}{ccc}
 T & \xrightarrow{\langle a,b \rangle} & \Omega \times \Omega & \xrightarrow{\Rightarrow} & \Omega \\
 & \searrow & \text{---} & \text{---} & \nearrow \\
 & & & a \Rightarrow b & 
 \end{array}$$

has the property that

$$a \Rightarrow b = true_T \quad \text{if and only if} \quad \langle a, b \rangle \in \Omega \times \Omega \subseteq, e$$

which means precisely

$$a \wedge b = a \quad \text{if and only if} \quad a \subseteq b.$$

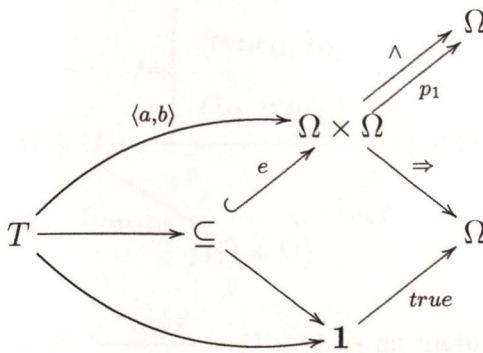

Now, because  $T \xrightarrow{a} \Omega$  is a map whose codomain is  $\Omega$ , by the defining property of  $\Omega$ , it must be the classifying map of some subobject of  $T$ ,  $A \xrightarrow{\alpha} T$ . In the same way  $T \xrightarrow{b} \Omega$  is the classifying map of some other subobject of  $T$ ,  $B \xrightarrow{\beta} T$ , and



the subobject classified by  $T \xrightarrow{a \Rightarrow b} \Omega$  is called the *implication* of  $A, \alpha$  and  $B, \beta$ , denoted by  $(A \Rightarrow B) \xrightarrow{\alpha \Rightarrow \beta} T$ .

The implication of two subobjects of  $T$  is, in fact, the map object of these objects considered as objects of  $\mathcal{P}(T)$ . Thus, the ‘exactly one’ condition on the evaluation map of the map object formed from two objects in  $\mathcal{P}(T)$  becomes:

$$\alpha \wedge (\alpha \Rightarrow \eta) \subseteq_T \eta \quad \text{induces} \quad \frac{\xi \subseteq_T (\alpha \Rightarrow \eta)}{(\alpha \wedge \xi) \subseteq_T \eta}$$

**Disjunction & Subobject Union**

Form the product  $\Omega \times \Omega$  and define the product maps  $\Omega \xrightarrow{\langle true_\Omega, 1_\Omega \rangle} \Omega \times \Omega$  and  $\Omega \xrightarrow{\langle 1_\Omega, true_\Omega \rangle} \Omega \times \Omega$ . Form the sum  $\Omega + \Omega$  and then define the sum map  $f$

$$\Omega + \Omega \xrightarrow{f = \begin{cases} \langle true_\Omega, 1_\Omega \rangle \\ \langle 1_\Omega, true_\Omega \rangle \end{cases}} \Omega \times \Omega$$

from the two product maps. Now find the *image* of this sum map by forming the *epi-monic factorisation* of the sum map  $f$

$$\begin{array}{ccc} \Omega + \Omega & \xrightarrow{f = \begin{cases} \langle true_\Omega, 1_\Omega \rangle \\ \langle 1_\Omega, true_\Omega \rangle \end{cases}} & \Omega \times \Omega \\ & \searrow f|_{f(\Omega + \Omega)} & \nearrow \text{img } f \\ & f(\Omega + \Omega) & \end{array}$$

The image map  $f(\Omega + \Omega) \xrightarrow{\text{img } f} \Omega \times \Omega$  is an inclusion map because it is the monic part of an epi-monic factorisation of the above sum map  $f$ ; therefore this is a subobject and it has a classifying or characteristic map  $\Omega \times \Omega \xrightarrow{\vee} \Omega$ . This classifying map is the logical operation of *disjunction*. The property of this

operation is that for any  $T \xrightarrow{\langle a,b \rangle} \Omega \times \Omega$  where  $a$  and  $b$  are maps from  $T$  to  $\Omega$ , the composite

$$T \xrightarrow{\langle a,b \rangle} \Omega \times \Omega \xrightarrow{\vee} \Omega$$

$$T \xrightarrow{a \vee b} \Omega$$

has the property that

$$a \vee b = true_T \quad \text{if and only if} \quad \langle a, b \rangle \in_{\Omega \times \Omega} f(\Omega + \Omega), \text{img } f$$

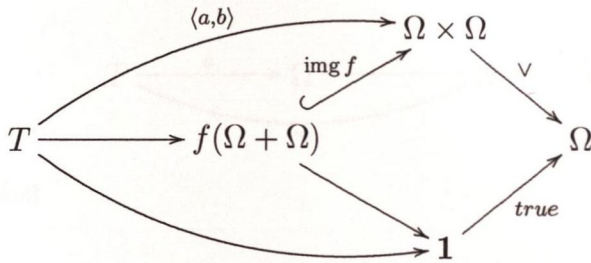

Now, because  $T \xrightarrow{a} \Omega$  is a map whose codomain is  $\Omega$ , by the defining property of  $\Omega$  it must be the classifying map of some subobject of  $T$ ,  $A \xrightarrow{\alpha} T$ . In the same way  $T \xrightarrow{b} \Omega$  is the classifying map of some other subobject of  $T$ ,  $B \xrightarrow{\beta} T$ , and the subobject classified by  $T \xrightarrow{a \vee b} \Omega$  is called the *union* of  $A, \alpha$  and  $B, \beta$ , denoted by  $(A \vee B) \xrightarrow{\alpha \vee \beta} T$ .

The union of two subobjects of  $T$  is, in fact, the sum of these objects considered as objects of  $\mathcal{P}(T)$ . The sum of two objects of  $\mathcal{P}(T)$  is the image of the sum of these objects considered as objects of  $\mathcal{C}/X$ . Thus, the ‘exactly one’ condition on the injection maps for the sum of two objects in  $\mathcal{P}(T)$  becomes:

$$\beta_1 \subseteq_T \beta_1 \vee \beta_2 \subseteq_T \beta_2 \quad \text{induces} \quad \frac{\beta_1 \vee \beta_2 \subseteq_T \eta}{\beta_1 \subseteq_T \eta \quad \text{and} \quad \beta_2 \subseteq_T \eta}$$



**Negation**

Consider the unique map  $0 \hookrightarrow 1$  from an initial object to a terminal object. This map is an inclusion map; therefore this is part of the object  $1$  and it has a classifying or characteristic map  $1 \xrightarrow{false} \Omega$ . This classifying map is called *false*.

The map  $1 \xrightarrow{false} \Omega$  is an inclusion map because its domain is terminal; therefore this is a subobject of the object  $\Omega$  and it has a classifying or characteristic map  $\Omega \rightrightarrows \Omega$ . This classifying map is the logical operation of *negation*. The property of this operation is that for any  $T \xrightarrow{a} \Omega$ , the composite

$$\begin{array}{ccccc}
 T & \xrightarrow{a} & \Omega & \xrightarrow{\neg} & \Omega \\
 & \searrow & & \nearrow & \\
 & & & \neg a & 
 \end{array}$$

has the property that

$$\neg a = true_T \quad \text{if and only if} \quad a \in_{\Omega} 1, false$$

which means precisely

$$a = false_T.$$

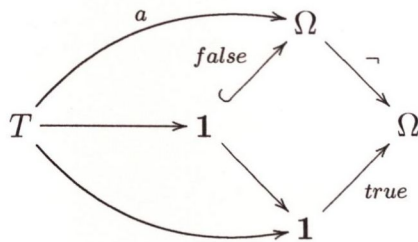

Now, because  $T \xrightarrow{a} \Omega$  is a map whose codomain is  $\Omega$ , by the defining property of  $\Omega$  it must be the classifying map of some subobject of  $T$ ,  $A \hookrightarrow T$ . The subobject classified by  $T \xrightarrow{a} \Omega$  is called the *negation* of the subobject  $A$ ,  $\alpha$  with respect to the object  $T$ , denoted by  $(\neg A \text{ wrt } T) \hookrightarrow T$ .





# Bibliography

- Barr, M. and C. Wells (1995). *Category Theory for Computing Science* (Second ed.). International Series in Computer Science. London: Prentice Hall.
- Bell, J. L. (1988). *Toposes and Local Set Theories: An Introduction*. Number 14 in Oxford Logic Guides. Oxford: Oxford Science Publications.
- Bird, R. S. (1987). An Introduction to the Theory of Lists. In M. Broy (Ed.), *Logic of Programming and Calculi of Discrete Design: International Summer School directed by F. L. Bauer, M. Broy, E. W. Dijkstra, C. A. R. Hoare*, Volume 36 of *NATO ASI Series F: Computer and System Sciences*, pp. 4–42. Berlin: Springer-Verlag. Proceedings of the NATO Advanced Study Institute on Logic of Programming and Calculi of Discrete Design held in Marktoberdorf, Federal Republic of Germany, July 29 – August 10, 1986.
- Bjørner, D. and C. B. Jones (1978). *The Vienna Development Method: The Meta-Language*. Number 61 in Lecture Notes in Computer Science. Berlin Heidelberg New York: Springer-Verlag.
- Bjørner, D. and C. B. Jones (1982). *Formal Specification and Software Development*. Englewood Cliffs, New Jersey: Prentice-Hall International.
- Blikle, A. (1987). Denotational Engineering or From Denotations to Syntax. In

- D. Bjørner, C. B. Jones, M. Mac an Airchinnigh, and E. J. Neuhold (Eds.), *VDM'87, VDM — A Formal Method at Work*, Number 252 in Lecture Notes in Computer Science, Berlin Heidelberg, pp. 151–209. Springer-Verlag.
- Blikle, A. (1988). Three-valued Predicates for Software Specification. In R. Bloomfield, L. Marshall, and R. Jones (Eds.), *VDM'88, VDM — The Way Ahead*, Number 328 in Lecture Notes in Computer Science, Berlin Heidelberg, pp. 243–66. Springer-Verlag.
- Blikle, A. (1990). On Conservative Extensions of Syntax in the Process of System Development. In D. Bjørner, C. A. R. Hoare, and H. Langmaack (Eds.), *VDM'90, VDM and Z — Formal Methods in Software Development*, Number 428 in Lecture Notes in Computer Science, Berlin Heidelberg, pp. 504–525. Springer-Verlag.
- Butterfield, A. (1993). A VDM<sup>+</sup> Study of Fault Tolerant Stable Storage - Towards a Computer Engineering Mathematics. In J. Woodcock and P. Larsen (Eds.), *FME'93: Industrial Strength Formal Methods*, Number 670 in Lecture Notes in Computer Science, Berlin, pp. 671 – 678. Springer-Verlag.
- Butterfield, A. (1998). Recursion Diagrams. In D. Duke and A. Evans (Eds.), *NFM'98: 3rd Northern Formal Methods Workshop, Ilkley 1997*, Electronic Workshops in Computing, London. British Computer Society. <http://ewic.org.uk/ewic/workshops/view.cfm/NFM-98>.
- Casti, J. L. (1997). *Reality rules: I Picturing the World in Mathematics — The Fundamentals* —. Wiley Professional Paperback Series. New York: John Wiley & Sons, Inc.
- Courant, R. (1962). *Partial Differential Equations*, Volume II of *Methods of*



*Mathematical Physics*. New York: Interscience Publishers a division of John Wiley & Sons.

Darling, R. W. R. (1994). *Differential Forms and Connections*. Cambridge University Press.

Donnelly, A., D. Gallagher, and A. Hughes (1996, March). On the Inheritance of Monoid Properties in Indexed Structures, A Tale of Three Proofs. Technical Report TCD-CS-96-04, Department of Computer Science, University of Dublin, Trinity College, Dublin, Ireland. <http://www.cs.tcd.ie/publications/tech-reports/tr-index.96.html>.

Durbin, J. R. ([1979, 1985] 1992). *Modern Algebra: An Introduction* (Third ed.). New York: John Wiley & Sons, Inc.

Eilenberg, S. (1976). *Automata, Languages, and Machines*, Volume B. New York: Academic Press, Inc.

Farrell, A. (1997). Proof Methods and Proofs in the Irish School of Constructive Mathematics. Master's thesis, Department of Computer Science, University of Dublin, Trinity College, Dublin, Ireland.

Finkbeiner II, D. T. ([1960] 1966). *Introduction to Matrices and Linear Transformations* (Second ed.). A Series of Books in Mathematics. San Francisco and London: W. H. Freeman and Company.

Goguen, J. (1992). Sheaf Semantics for Concurrent Interacting Objects. *Mathematical Structures in Computer Science* 11, 159–191. Given as lecture at Engeler Festschrift, Zürich, 7 March 1989, and at U.K.-Japan Symposium on Concurrency, Oxford, September 1989; draft as Report CSLI-91-155,

- Center for the Study of Language and Information, Stanford University, June 1991.
- Goldblatt, R. ([1979] 1984). *Topoi: The Categorical Analysis of Logic* (Revised ed.). Number 98 in *Studies in Logic and the Foundations of Mathematics*. Amsterdam: North-Holland.
- Gries, D. and F. B. Schneider (1994). *A Logical Approach to Discrete Math*. Texts and Monographs in Computer Science. New York: Springer-Verlag.
- Hoare, C. A. R. (1999). Theories of Programming: Top-Down and Bottom-Up and Meeting in the Middle. In J. M. Wing, J. Woodcock, and J. Davies (Eds.), *FM'99 — Formal Methods*, Number 1708 in *Lecture Notes in Computer Science*, Berlin Heidelberg, pp. 1–27. Springer-Verlag. World Congress on Formal Methods in the Development of Computing Systems Toulouse, France, September 20–24, 1999 Proceedings Volume I.
- Holcombe, W. M. L. (1982). *Algebraic Automata Theory*. Number 1 in *Cambridge studies in advanced mathematics*. Cambridge: Cambridge University Press.
- Hughes, A. (1994, June). Outer laws for the indexed monoid. B.A. (Mod) dissertation, Department of Computer Science, University of Dublin, Trinity College, Dublin, Ireland.
- Hughes, A. (1997a, January). A Semi-group of Hashing Functions & Hash Tables. Technical Report TCD-CS-97-03, Department of Computer Science, University of Dublin, Trinity College, Dublin, Ireland. <http://www.cs.tcd.ie/publications/tech-reports/tr-index.97.html>.



Hughes, A. (1997b, January). The Monoid of Inverse Maps. Technical Report TCD-CS-97-02, Department of Computer Science, University of Dublin, Trinity College, Dublin, Ireland. <http://www.cs.tcd.ie/publications/tech-reports/tr-index.97.html>.

Hughes, A. (1998). Towards an Override in Topoi. In A. Butterfield and S. Flynn (Eds.), *2nd Irish Workshop on Formal Methods, Cork 1998*, Electronic Workshops in Computing, London. British Computer Society. <http://ewic.org.uk/ewic/workshops/view.cfm/IWFM-98>.

Hughes, A. (2000a, February). Algebraic Foundations for Partial Map Operators Reconsidered. Lecture presented to the Department of Computer Science TCD as a Departmental Seminar.

<http://www.cs.tcd.ie/seminars/year1999-00/20000204AH.html>

The lecture refined the existing foundations for partial map operators in the Irish School of the VDM using (i) inner laws and morphisms, and (ii) outer laws and morphisms. By proving two basic identities one demonstrates the advantages of the refined foundations. In addition one also identifies the boundary between the algebraic and categorical foundations.

This lecture was also presented to the TCD Foundations and Methods Group in October 1999.

Hughes, A. (2000b, April). Indexed monoids with unit. Lecture presented to the Summer School and Workshop on Algebraic and Coalgebraic Methods in the Mathematics of Program Construction in Lincoln College, Oxford.

<http://web.comlab.ox.ac.uk/oucl/research/areas/ap/acmmpc/>

The lecture introduced an indexed monoid with unit and verified its

monoidal properties algebraically.

This lecture was also presented to the Irish Formal Methods Special Interest Group Winter Workshop which took place in Trinity College Dublin in February 2000.

[http://www.cs.tcd.ie/research\\_groups/fmg/IFMSIG/winter2000/](http://www.cs.tcd.ie/research_groups/fmg/IFMSIG/winter2000/).

Hughes, A. and A. Donnelly (1997). Algebraic Advances for Aliasing. In D. Duke and A. Evans (Eds.), *Northern Formal Methods Workshop, Ilkley 1997*, Electronic Workshops in Computing, London. British Computer Society. <http://ewic.org.uk/ewic/workshops/view.cfm/NFM-97>.

Hughes, A. and C. Pahl (1997). A Generic Model for State-based Agent Systems. In G. O'Regan and S. Flynn (Eds.), *1st Irish Workshop on Formal Methods, Dublin 1997*, Electronic Workshops in Computing, London. British Computer Society. <http://ewic.org.uk/ewic/workshops/view.cfm/IWFM-97>.

Hughes, A. P. and A. A. Donnelly (1995, September). An Algebraic Proof in VDM<sup>♣</sup>. In J. Bowen and M. Hinchey (Eds.), *ZUM'95: The Z Formal Specification Notation*, Number 967 in Lecture Notes in Computer Science, Berlin, pp. 114 – 133. Springer-Verlag.

Jacobson, N. (1974). *Basic Algebra I*. San Francisco: W. H. Freeman and Company.

Johnstone, P. T. (1977). *Topos Theory*. Number 10 in L.M.S. Monographs. London: Academic Press.

Jones, C. B. (1986). *Systematic Software Development Using VDM*. Englewood Cliffs, New Jersey: Prentice-Hall International.



- Jones, C. B. (1987). Program Specification and Verification in VDM. In M. Broy (Ed.), *Logic of Programming and Calculi of Discrete Design: International Summer School directed by F. L. Bauer, M. Broy, E. W. Dijkstra, C. A. R. Hoare*, Volume 36 of *NATO ASI Series F: Computer and System Sciences*, pp. 149–84. Berlin: Springer-Verlag. Proceedings of the NATO Advanced Study Institute on Logic of Programming and Calculi of Discrete Design held in Marktoberdorf, Federal Republic of Germany, July 29 – August 10, 1986.
- Jones, C. B. (1999). Scientific Decisions which Characterize VDM. In J. M. Wing, J. Woodcock, and J. Davies (Eds.), *FM'99 — Formal Methods*, Number 1708 in *Lecture Notes in Computer Science*, Berlin Heidelberg, pp. 28–47. Springer-Verlag. World Congress on Formal Methods in the Development of Computing Systems Toulouse, France, September 20–24, 1999 Proceedings Volume I.
- Kline, M. (1972). *Mathematical Thought from Ancient to Modern Times*. New York: Oxford University Press.
- Lawvere, F. W. (1975). Variable Sets, Etendu and Variable Structure in Topoi. Notes by Steven Landsburg of Lectures and Conversations, Department of Mathematics, The University of Chicago.
- Lawvere, F. W. (1976). Variable Quantities and Variable Structures in Topoi. In A. Heller and M. Tierney (Eds.), *Algebra, Topology and Category Theory: a collection of papers in honor of Samuel Eilenberg*, pp. 101 – 131. New York: Academic Press.
- Lawvere, F. W. and S. H. Schanuel (1997). *Conceptual Mathematics: A first*

*introduction to categories*. Cambridge: Cambridge University Press. An earlier version was published by the Buffalo Workshop Press, 1991, with an Italian translation, Franco Muzzio &c editore spa in 1994.

Mac an Airchinnigh, M. (1987). Mathematical Structures and their Morphisms in Meta IV. In D. Bjørner, C. B. Jones, M. Mac an Airchinnigh, and E. J. Neuhold (Eds.), *VDM'87, VDM — A Formal Method at Work*, Number 252 in Lecture Notes in Computer Science, Berlin, pp. 287 – 320. Springer-Verlag.

Mac an Airchinnigh, M. (1990). *Conceptual Models and Computing*. Ph. D. thesis, Department of Computer Science, University of Dublin, Trinity College, Dublin, Ireland.

Mac an Airchinnigh, M. (1991). Tutorial Lecture Notes on the Irish School of the VDM. In S. Prehn and W. J. Toetenel (Eds.), *VDM'91, Formal Software Development Methods Volume 2: Tutorials*, Number 552 in Lecture Notes in Computer Science, Berlin, pp. 141 – 237. Springer-Verlag.

Mac an Airchinnigh, M. (1993, May). Formal Methods & Testing. In *Tutorials of the Sixth International Software Quality Week*, 625 Third Street, San Francisco, CA 94107-1997. Software Research Institute.

Mac an Airchinnigh, M. (1995, June). The Garden. Question 5 in Part II of the B.A. (Mod.) Computer Science 4BA1 Information Systems Examination Paper CS4B1A1, Department of Computer Science, University of Dublin, Trinity College, Dublin, Ireland.

Mac an Airchinnigh, M. (1998, May). The Farm. Question 5 in Part II of the B.A. (Mod.) Computer Science 4BA1 Information Systems Examination



- Paper CS4B1A1, Department of Computer Science, University of Dublin, Trinity College, Dublin, Ireland.
- Mac an Airchinnigh, M. and A. Hughes (1997). The Geometry of Distributions in Formal Methods. In D. Duke and A. Evans (Eds.), *2nd BCS-FACS Northern Formal Methods Workshop, Ilkley 1997*, Electronic Workshops in Computing, London. British Computer Society. <http://ewic.org.uk/ewic/workshops/view.cfm/NFM-97>.
- Mac Lane, S. and I. Moerdijk (1992). *Sheaves in Geometry and Logic: A First Introduction to Topos Theory*. Universitext. New York: Springer-Verlag.
- McLarty, C. (1992). *Elementary Categories, Elementary Toposes*. Number 21 in Oxford Logic Guides. Oxford: Clarendon Press.
- O'Regan, G. (1995, April). Bill of Materials:- A Rigorous Approach. Technical Report TCD-CS-95-08, Department of Computer Science, University of Dublin, Trinity College, Dublin, Ireland.
- O'Regan, G. (1997). *Applying Formal Methods to Model Organizations and Structures in the Real World*. Ph. D. thesis, Department of Computer Science, University of Dublin, Trinity College, Dublin, Ireland.
- Papy, G. (1964). *Groups*. London: Macmillan & Company Ltd. Translated from French by Mary Warner. Paris: Dunod, 1961.
- Pierce, B. C. (1988). A Taste of Category Theory for Computer Scientists. Technical Report CMU-CS-88-203, Computer Science Department, Carnegie Mellon University, Pittsburgh, PA 15213.
- Schewe, K.-D. (1995). *Specification of Data-Intensive Application Systems*.

Habilitationsschrift, Faculty of Mathematics, Science and Informatics,  
Technical University of Cottbus, Germany.

Singh, S. (1997). *Fermat's Last Theorem*. London: Fourth Estate.

Spivak, M. (1967). *Calculus*. World Student Series. London: Addison-Wesley  
Benjamin, Inc.

van der Poorten, A. (1996). *Notes on Fermat's Last Theorem*. Canadian Math-  
ematical Society Series of Monographs and Advanced Texts. New York: A  
Wiley-Interscience Publication, John Wiley & Sons, Inc.



# Notation Index

## Algebraic Structures

- $(S, *)$  inner law  $*$  in set  $S$ , 135
- $(S, *, v)$  monoid of  $S$  under  $*$  with identity element  $v$ , 167
- $S^{\circlearrowright \Omega}$  outer law  $\Omega$  on set  $S$ , 151
- $S^{\circlearrowright (\Omega, *, u)}$  outer law monoid on set  $S$ , 179

## Arrows

- $\rightarrow$  map, morphism, functor, 191
- $\hookrightarrow$  inclusion map, 196
- $\rightsquigarrow$  partial map, 191
- $\mapsto$  effect of map on an element, 193

## Logic

- $\wedge$  and, 193
- $\equiv$  equivalence, 191
- $\forall$  for all, 197
- $\Rightarrow$  implies, 197
- $\vee$  or, 192
- $\exists$  there exist, 197

## Maps

- $g \circ f$  composition of map  $g$  after map  $f$ , 200
- $1_X$  identity map on set  $X$ , 202
- $f|_S$  restriction of map  $f$  to codomain  $S$ , 94
- $f|_R$  restriction of map  $f$  to domain  $R$ , 94
- $f|_S^R$  restriction of map  $f$  to domain  $R$  and codomain  $S$ , 94

## Partial Maps

- $[x \mapsto y | \varphi(x, y)]$  partial map with  $x$  mapping to  $y$  if property  $\varphi$ , 193
- $\theta$  empty partial map, 137

## Inner Laws

- $\mu \sqcup \nu$  extend partial map  $\mu$  by partial map  $\nu$ , 192
- $\mu \cup \nu$  glue partial map  $\mu$  to partial

- map  $\nu$ , 194
- $\mu \cap \nu$  intersect partial map  $\mu$  with partial map  $\nu$ , 195
- $\mu \dagger \nu$  override partial map  $\mu$  by partial map  $\nu$ , 195

**Operators**

- $\mu(x)$  application of partial map  $\mu$  to element  $x$  in  $\text{dom } \mu$ , 192
- $\text{cod } \mu$  codomain of partial map  $\mu$ , 192
- $\nu \cdot \mu$  composition of partial map  $\nu$  after partial map  $\mu$ , 200
- $\mu(S)$  direct image of set  $S$  under partial map  $\mu$ , 197
- $\text{dom } \mu$  domain of partial map  $\mu$ , 191
- $\exists_\mu S$  existential image of set  $S$  under partial map  $\mu$ , 197
- $\text{img } \mu$  image of partial map  $\mu$ , 192
- $\mu^{-1}S$  inverse image of set  $S$  under partial map  $\mu$ , 196
- $\text{phom}(f, g)\mu$   
 phom map acting on partial map  $\mu$ , 201
- $\text{rng } \mu$  range of partial map  $\mu$ , 192

- $\forall_\mu S$  universal image of set  $S$  under partial map  $\mu$ , 197

**Outer Laws**

- $\triangleleft_S \mu$  removal of set  $S$  from partial map  $\mu$ , 193
- $\triangleleft_S \mu$  restriction of partial map  $\mu$  to set  $S$ , 194
- $\triangleright_S \mu$  range removal of set  $S$  from partial map  $\mu$ , 198
- $\triangleright_S \mu$  range restriction of partial map  $\mu$  to set  $S$ , 199

**Sets**

- $\{x \mid \varphi(x)\}$   
 set of  $x$  with property  $\varphi$ , 192
- $\emptyset$  empty set, 137

**Inner Laws**

- $R \cap S$  intersect set  $S$  with set  $R$ , 135
- $R \cup S$  union set  $S$  with set  $R$ , 135

**Outer Laws**

- $\triangleleft_R S$  removal of set  $R$  from set  $S$ , 151
- $\triangleleft_R S$  restriction of set  $S$  by set  $R$ , 151